



Texas Commission on Environmental Quality Waste Permits Division Correspondence Cover Sheet

Date: 03/07/2025

Facility Name: City of Del Rio Landfill

Permit or Registration No.: MSW 207C

Nature of Correspondence:

Initial/New

Response/Revision to TCEQ Tracking No.:
29656107 (from subject line of TCEQ letter
regarding initial submission)

Affix this cover sheet to the front of your submission to the Waste Permits Division. Check appropriate box for type of correspondence. Contact WPD at (512) 239-2335 if you have questions regarding this form.

Table 1 - Municipal Solid Waste Correspondence

Applications	Reports and Notifications
<input type="checkbox"/> New Notice of Intent	<input type="checkbox"/> Alternative Daily Cover Report
<input type="checkbox"/> Notice of Intent Revision	<input type="checkbox"/> Closure Report
<input type="checkbox"/> New Permit (including Subchapter T)	<input type="checkbox"/> Compost Report
<input type="checkbox"/> New Registration (including Subchapter T)	<input type="checkbox"/> Groundwater Alternate Source Demonstration
<input checked="" type="checkbox"/> Major Amendment	<input type="checkbox"/> Groundwater Corrective Action
<input type="checkbox"/> Minor Amendment	<input type="checkbox"/> Groundwater Monitoring Report
<input type="checkbox"/> Limited Scope Major Amendment	<input type="checkbox"/> Groundwater Background Evaluation
<input type="checkbox"/> Notice Modification	<input type="checkbox"/> Landfill Gas Corrective Action
<input type="checkbox"/> Non-Notice Modification	<input type="checkbox"/> Landfill Gas Monitoring
<input type="checkbox"/> Transfer/Name Change Modification	<input type="checkbox"/> Liner Evaluation Report
<input type="checkbox"/> Temporary Authorization	<input type="checkbox"/> Soil Boring Plan
<input type="checkbox"/> Voluntary Revocation	<input type="checkbox"/> Special Waste Request
<input type="checkbox"/> Subchapter T Disturbance Non-Enclosed Structure	<input type="checkbox"/> Other:
<input type="checkbox"/> Other:	

Table 2 - Industrial & Hazardous Waste Correspondence

Applications	Reports and Responses
<input type="checkbox"/> New	<input type="checkbox"/> Annual/Biennial Site Activity Report
<input type="checkbox"/> Renewal	<input type="checkbox"/> CPT Plan/Result
<input type="checkbox"/> Post-Closure Order	<input type="checkbox"/> Closure Certification/Report
<input type="checkbox"/> Major Amendment	<input type="checkbox"/> Construction Certification/Report
<input type="checkbox"/> Minor Amendment	<input type="checkbox"/> CPT Plan/Result
<input type="checkbox"/> CCR Registration	<input type="checkbox"/> Extension Request
<input type="checkbox"/> CCR Registration Major Amendment	<input type="checkbox"/> Groundwater Monitoring Report
<input type="checkbox"/> CCR Registration Minor Amendment	<input type="checkbox"/> Interim Status Change
<input type="checkbox"/> Class 3 Modification	<input type="checkbox"/> Interim Status Closure Plan
<input type="checkbox"/> Class 2 Modification	<input type="checkbox"/> Soil Core Monitoring Report
<input type="checkbox"/> Class 1 ED Modification	<input type="checkbox"/> Treatability Study
<input type="checkbox"/> Class 1 Modification	<input type="checkbox"/> Trial Burn Plan/Result
<input type="checkbox"/> Endorsement	<input type="checkbox"/> Unsaturated Zone Monitoring Report
<input type="checkbox"/> Temporary Authorization	<input type="checkbox"/> Waste Minimization Report
<input type="checkbox"/> Voluntary Revocation	<input type="checkbox"/> Other:
<input type="checkbox"/> 335.6 Notification	
<input type="checkbox"/> Other:	



March 7, 2025

Savannah Rains
Solid Waste Permit Section MC-109
Texas Commission on Environmental Quality
12100 Park 35 Circle
Austin, TX 78753

Re: Response to Technical Notice of Deficiency (NOD)
City of Del Rio
Del Rio, Val Verde County, Texas
Proposed Municipal Solid Waste Permit No: 207C
Tracking No. 29656107; RN102143294/CN600756290
Permit Major Amendment Application

Dear Ms. Rains,

On behalf of the City of Del Rio, please find attached a response to the technical notice of deficiency for the referenced permit amendment application. The replacement pages enclosed have been updated to incorporate comments included in the 2nd Technical NOD letter.

To facilitate your review, the NOD Table with the comments and response is enclosed. If you have any questions, please do not hesitate to contact me.

Sincerely,

A handwritten signature in blue ink that reads 'Tewobista Metaferia'. The signature is written in a cursive, flowing style.

Tewobista Metaferia, P.E.
Project Engineer

cc: Shawna Burkhart, City Manager
TCEQ Region 16



Technical NOD #2

ID	App. Part	App. Section	Location	Citation	Error Type	Deficiency Description/Resolution
NT1	3	General	305.45(a)	Part III Appendix IIIB	Omitted	<p>Comment: Upon receipt of a response from TxDOT, revise the TCEQ Transportation Data and Report Form No. 20719 as necessary. This includes correcting information in Section V for the facility address and operating hours.</p> <p>Response: Response: Section II has been updated to show that TXDOT response has been received and note the TXDOT response. Section V has also been updated to correct the facility address and operating hours. In addition, Section XI was updated to note FAA coordination.</p>
NT2	24	General	330.57(g)(5)	Page numbers provided on all sheets	Inconsistent	<p>Comment: a)The NOD1 response states that "A complete replacement of Appendix IIIB has been provided with this submittal." Upon review of the resubmitted appendix, it was noted that the new Table 3-1 appears to be a duplicate of Table 3-2 and different than what was originally submitted, please revise to be accurate. b)Revise Section IIIB 5.3 to refer to the "alternative liner design" instead of the groundwater waiver.</p> <p>Response: a) Table 3-1 has been revised to show the Typical Chemical Constituent Concentrations in Leachate as stated in Section 3. The title of the table and Table of Contents have been updated for consistency. b) The text in Section 5.3 has been updated to refer to the "alternative liner design" instead of the groundwater waiver.</p>
NT3	122	Part I	305.45(a)(8)(C)		Inconsistent	<p>Comment: a) Update Section 17 of the Part I form since Tim Giardina is no longer with Platform Waste Solutions LLC. b) The NOD1 response states that the Public Works Director, Alberto Quintanilla, is no longer with the city. Update Section 6 of the Part 1 form for who is responsible for publishing notice. c) Ensure that Section 1 of the Part 1 form has notice of deficiency (NOD) response selected in future response submittals. d) Be aware that after the upcoming elections, Section 20 of the Part 1 form may need to be updated. e) Discrepancies were noted between the hard copies sent to TCEQ and the PDFs uploaded to the consultant's webpage. For example: Section A of TCEQ-20720, permit Page 822, has the permeability corrected according to NOD1 Comment NT2 in the hard copy, while the PDF is uncorrected. All future hard copy and electronic submittals must be identical.</p> <p>Response: a) Section 17 of the Part I Form has been updated to remove Tim Giardina's name. Section 12 on the same page has been updated to note the new City Manger. b) Section 6 of the Part I Form has been updated to note the new Public Works Director for the City. c) Section 1 of the Part I Form has been updated for this submittal. d) Section 20 of the Part I Form has been verified with the 2024 election results, no changes are needed. e) Noted.</p>
NT4	141	Part II	330.61(i)(4)	I/IIB	Incomplete	<p>Comment: Include the letter regarding site access adequacy and traffic/location restrictions from TxDOT in Appendix I/IIB when received.</p> <p>Response: The TXDOT response letter has been included in Appendix I/IIB (permit page -231).</p>

Technical NOD #2

ID	App. Part	App. Section	Location	Citation	Error Type	Deficiency Description/Resolution
NT5	142	Part II	330.61(i)(5)	Parts I/II Section 8	Incomplete	Comment: Include the letter from the FAA regarding the impact related to wildlife attractants in Appendix I/IIB when received. Response: The FAA response letter has been included in Appendix I/IIB (permit page -101).
NT6	146	Part II	330.545(b)	I/IIB	Omitted	Comment: a) The NOD1 response states that the notifications to airports located in a 6-mile radius of the facility were included in this submittal, but they were not found. Include the notifications in Appendix I/IIB. b) Pages I/IIB 35-45 were left blank for an unknown purpose. Please advise what these pages are being saved for. Response: a) The City of Del Rio International Airport is managed by the City of Del Rio. The notification to the airports has been included in Appendix I/IIB of this submittal (permit pages -134 to 144h). b) The airport notification letters are on Pages I/IIB 35-45h.
T7	163	Part II	330.61(m)(2)	Parts I/II Section 11, Appendix I/IIC Section 7	Ambiguous	Comment: The NOD response and revisions to address Comment NT21 of the first NOD are insufficient. It is noted that correspondence with the USACE included on Page I/IIB-203 states that the project area contains potential waters of the U.S. that may be under the USACE’s regulatory jurisdiction. The revised Section 11.2 of Parts I/II states that the filling of one tenth of an acre at this site would be covered by the Nationwide Permit (NWP) 14 without notifying the USACE. Revise to include copies of correspondence with the USACE that shows the USACE has made the determination of waters under its jurisdiction for this site (not just the one tenth of an acre) and has issued a specific NWP or a permit for this site. Include copies of the USACE issued authorization. Language in Appendix I/II Section 11.2, Appendix I/IIC Section 7.0, Appendix III Sections 3.1 and 3.8, and any other applicable sections need to be updated accordingly. Response: Additional coordination with USACE was completed in January 2025 to obtain a Nationwide Permit. The NWP 39 that was issued for the site is included in Appendix I/IIB. Section 11.2 of Parts I/II and Section 7 of Appendix I/IIC text have been updated to reflect these changes.
NT8	166	Part II	330.61(n)(2)	Parts I/II Section 12, Appendix I/IIC Section 6	Incomplete	Comment: Include the letter from the Texas Parks and Wildlife Department regarding the impact related to wildlife attractants in Appendix I/IIB when received. Response: The Texas Parks and Wildlife response letter has been included in Appendix I/IIB (permit page -242). The text in Section 12 in Parts I/II has been updated based on the recommendations in the Texas Parks and Wildlife response letter.
NT9	168	Part II	330.61(p)	Parts I/II Section 2.4	Incomplete	Comment: Include the response letter from the Middle Rio Grande Development Council in Appendix I/IIB when received. Response: The draft meeting minutes from the Middle Rio Grade Development Council Board Meeting that shows the approval of the expansion project has been included in Appendix I/IIB (permit page -505).

Technical NOD #2

ID	App. Part	App. Section	Location	Citation	Error Type	Deficiency Description/Resolution
T10	266	Part II	330.559	Parts I/II Section 9, Appendix I/IIC Section 8	Incomplete	<p>Comment: The response to Comment T32 of the first NOD states, “A complete replacement of Appendix III L has been provided with this submittal.” However, Appendix III L is missing in the NOD1 response submittal. Provide the complete Appendix III L. Address all NOD1 comments that pertain to III L (including, but not limited to, T32 of the first NOD).</p> <p>Response: Below are the comments and responses to comment T32 from the first NOD.</p> <p>a</p> <p>Comment: Table of Contents for Appendix III L lists Appendix III L-A (Slope Stability Analysis) and Appendix III L-B (Settlement and Heave Analysis). Contents for Appendix III L-A and Appendix III L-B are missing. Provide Appendices III L-A-1, III L-A-2, III L-B-1, and III L-B-2 for review.</p> <p>Response: Appendix III L-A and III L-B have been included in this submittal. III L-A-1, III L-A-2, III L-B-1, and III L-B-2 have been consolidated into III L-A and III L-B.</p> <p>b</p> <p>Comment: Revise Section 5.4 of Appendix III L to discuss how representative properties are determined for the three strata of multiple constituents described in Section 3.2 (including clay, caliche, sand, shale, gravel, etc.).</p> <p>Response: Section 5.4 has been revised to discuss how representative properties are determined for the stratums.</p> <p>c</p> <p>Comment: Revise Section 3.3 to ensure all components in the liner, over liner, and final cover are included in the stability analysis. Revise other portions of the application as necessary. (Refer to comments on MRI IDs 359 and 685).</p> <p>Response: Slope stability has been done for the liner, overliner and final cover configurations. Refer to Appendix III L-A.</p> <p>d</p> <p>Comment: Revise Section 5.0 to clarify if veneer stability analysis has been conducted for liner system and final cover system; or, revise to include veneer stability analysis. (Refer to MRI IDs 359 and 685 for components in the liner and final cover systems). Ensure the analyzed scenarios include those when components are saturated with liquids/water.</p> <p>Response: Infinite slope stability calculations have been included in Appendix III L-A to address the veneer stability analysis requirements. Section 5.5 has been added to the text in Appendix III L to discuss infinite slope stability.</p> <p>e</p> <p>Comment: Revise Table 5-1 to clarify if (and explain why) the material strength parameters are representative of the materials to be used for the construction of the liner and final cover. Revise other relevant portions of the application as necessary.</p> <p>Response: The second paragraph in Section 5.4 has been updated to clarify why the material strength parameters are representative.</p>

Technical NOD #2

ID	App. Part	App. Section	Location	Citation	Error Type	Deficiency Description/Resolution
						<p>f Comment: Revise Section 5.2 to clarify if all worst-case critical sections have been selected and analyzed for stability. Revise as necessary. Response: Section 5.2 has been revised to note that the selected sections are the worst-case critical sections.</p> <p>g- Comment: Section 5.3 indicates that excavation slopes will be as steep as 2H:1V. Revise to include stability analysis for excavation slopes and liner slopes under dynamic load conditions. Justify if no dynamic load analysis is included. Response: The proposed expansion area does not include any 2:1 excavation slopes. Section 5.3 has been updated to reflect this change.</p>
NT11	289	Part III	330.63(c)	Site Development Plan Section 3, Appendix IIIH	Incomplete	<p>Comment: a) Revise the Table of Contents for Appendix IIIH to include Appendix IIIH-E, and correct the name of Appendix IIIH-D. b) Revise to ensure that the titles for Section 4.2 of Appendix IIIH are consistent in the Table of Contents for Appendix IIIH and the text portion. c) There are two figures labeled IIIH-B-4. Revise the figures as necessary. d) Revise the existing Table of Contents in each sub-Appendix of IIIH to include figures.</p> <p>Response: a) The Table of Contents (TOC) for Appendix IIIH (permit page 889) has been updated to correct IIIH-D and add IIIH-E. b) The TOC has been updated for consistency with the text portion. c) The Figure in Appendix IIIH-C has been revised to IIIH-C-4. d) The Table of Contents in each sub-Appendix IIIH have been updated to include figures. Refer to pages IIIH-A-i, IIIH-B-i, IIIH-C-i, IIIH-D-i, and IIIH-E-i. Page IIIH-E-i is a new page that has been added to address this comment.</p>

Technical NOD #2

ID	App. Part	App. Section	Location	Citation	Error Type	Deficiency Description/Resolution
T12	290	Part III	330.305(a)	Site Development Plan Section 3, Appendix IIIH	Incomplete	<p>Comment:</p> <p>a) While many concerns discussed under Comment T34 of the first NOD are addressed in the first NOD response, the responses and revisions for other concerns are deferred to the next round of technical NOD. The response to Comment T34(f) of the first NOD states that “Channel design is included in Appendix IIIH-C. The profiles and cross sections for Channel 1, 6, 7, and 8 will be included in the next technical NOD.” The response to T34(b) also indicates that the requested information will be included in the next technical NOD. It is noted that the responses to Comments T40 and T41 also indicate that the requested information or revisions will be provided with the second round of TCEQ comments. Ensure all comments are fully addressed; and all other relevant portions of the application are revised accordingly. Revise Appendix IIIH in its entirety and submit it for review.</p> <p>b) As evidenced in the first NOD comments (for example, but not limited to, T30, T32(a), T33(b), T43(a), NT52(b), NT55, and NT57), the deficiency of missing contents was a significant issue in the original submittal of the application. As a result, a complete detailed review of the application cannot be conducted without a complete application.</p> <p>c) The revisions to Figure IIIH.1 are insufficient. Discharge velocities at Ponds 2 and 3 are over 10 fps and no discharge conditions are provided for Ponds 1 and 4 in Figure IIIH.1. Revise drawings and text to provide discharge conditions for all ponds and address the concerns with erosion due to high discharge velocities. Clarify/justify if no erosion control/energy dissipating measure are provided. Ensure the cross sections and plan view drawings show the erosion control/energy dissipators (refer to discussions under a) of this comment).</p> <p>Response:</p> <p>a) All comments have been address with this submittal. The clean copy of the submittal includes Appendix IIIH in its entirety as requested.</p> <p>b) All missing components of the application have been provided in this submittal.</p> <p>c) Riprap will be utilized as an erosion control method for the low water level outlets. The updated drawings in IIIH reflect this change. The calculations for the riprap apron width and length at the low water crossing are provided starting on sheet IIIH-C-13.</p>

Technical NOD #2

ID	App. Part	App. Section	Location	Citation	Error Type	Deficiency Description/Resolution
T13	293	Part III	330.305(d)	Appendix IIIH	Incomplete	<p>Comment: The following comments are related to Appendix IIIH-E.</p> <ul style="list-style-type: none"> a)Section 2.0 refers to Page IIIH-D-10 for source of frost depth, while the frost depth figure is Page III-E-14. Revise as necessary. b)Clarify if the frost depth data presented on Page IIIH-E-14 is up to date; and, if applicable, revise the application as necessary. c) Section 3.0 states that the soil loss on intermediate cover will be no greater than 50 ton/ac/yr. Revise Section 2.0 and other relevant portions of the application, to include soil loss calculations, which specify all relevant parameters used (for example, but not limited to, maximum slope length/swale spacing, minimum vegetation ground coverage). It is noted that soil loss for the final cover is included in Appendix IIIH-E (Page IIIH-E-9 lists the vegetation coverages required for maintaining the soil losses to below 3 tons/ac/yr.). d)Ensure that swale spacing limits and minimum vegetation ground coverages for the final cover are specified in the Closure Plan (Appendix IIIE). e)Ensure that the minimum vegetation ground coverage(s) is specified in the Post-closure Care Plan (Appendix IIIF). Ensure inspection, maintenance, and reporting provisions are included in Appendix IIIF, that ensure maintenance of the required minimum vegetation ground coverage(s). f) Ensure Appendix IIIH-D (Final Cover Erosion Structure Design) properly considers factors evaluated in Appendix IIIH-E (for example, but not limited to, maximum swale spacing). <p>Response:</p> <ul style="list-style-type: none"> a) Page reference has been updated on page IIIH-E-2. b) The frost depth has been updated on page IIIH-E-2. The calculations on pages IIIH-E-8 and IIIH-E-9 have been updated to reflect this change and match page IIIH-E-14. c) The soil loss requirement for the intermediate cover will be the same as the final cover. Section 2 has been revised to include maximum swale length and spacing. d) Page IIIE-4 has been revised to include swale spacing limits and minimum vegetation ground coverages for the final cover. e) Minimum vegetation ground coverage is specified in Appendix IIIF - Post-closure Care Plan (TCEQ Form 20722 page 4). f) Appendix IIIH-D (Final Cover Erosion Structure Design) has been verified to make sure that the factors evaluated in Appendix IIIH-E are included in the design consideration, no design changes are required. In addition, Page IIIH-D-1 has been revised to note that maximum spacing and length of a swale.

Technical NOD #2

ID	App. Part	App. Section	Location	Citation	Error Type	Deficiency Description/Resolution
T14	295	Part III	330.305(d)(2)	Appendix IIIH	Inconsistent	<p>Comment: The original Comment 38 is missing from the NOD1 Table with no comments or responses provided by the applicant. Provide responses to Comment 38 of the first NOD.</p> <p>Response: Below are the comments and responses to comment T38 from the first NOD.</p> <p>a.</p> <p>Comment: The side slope gradient is specified to be 4:1 in Section 4.3.4 of Part III; variable side slope gradients are shown in the cross sections contained in Appendix IIIA-B. Revise to have 4:1 side slope gradient on all side slopes/segments or provide required stability analyses and additional information on slopes steeper than 4:1.</p> <p>Response: No final cover slopes exceed a gradient steeper than 4:1. The slope gradients are depicted in the plan view on the updated Figures IIIA-A.2 and IIIA-B.3.</p> <p>b.</p> <p>Comment: Some cross sections (for example, but not limited to, Cross Section F) in Appendix IIIA-B do not mark top and/or side slope gradients. Revise to specify slope gradients (may provide callout index for where the gradients are specified).</p> <p>Response: Slope gradients have been added to the cross-sections Figures in IIIA-B (IIIA-B.4 to IIIA-B.9)</p> <p>c.</p> <p>Comment: If there is no vertical expansion over the developed areas, final cover can be constructed per the slope specifications approved under MSW 207B. Revise relevant portions of the application for clarification as necessary. (Refer to comments on MRI ID 685).</p> <p>Response: Only a small portion of the landfill will not undergo a vertical expansion. The City intends to construct the final cover as outlined in this permit (297C).</p>
T15	301	Part III	330.305(g)	Appendix IIIH	Ambiguous	<p>Comment: The original Comment 39 is missing from the NOD1 Table with no comments or responses provided by the applicant. Provide responses to Comment 39 of the first NOD.</p> <p>Response: Below are the comments and responses to comment T39 from the first NOD.</p> <p>a.</p> <p>Comment: Revise Section 2.1 in Appendix IIIC to identify the locations where water would come into contact with solid waste, leachate, or gas condensate. Provide measures at each identified location for contaminated water containment and management/disposal.</p> <p>Response: Section 2.1 (page IIIC-1) has been revised. Page IIIC-2 has been included in this submittal due to text shift.</p> <p>b.</p> <p>Comment: Revise Section 2.3 in Appendix IIIC to define “sump” or refer to where it is defined in the application. Provide design and operation information for the sump as necessary. Note that surface water/runoff (contaminated or not) may not be routed to the leachate sumps.</p> <p>Response: Section 2.3 has been revised to remove the word sump.</p>
T16	305	Part III	330.63(c)(1)(B)	Appendix IIIH	Incomplete	<p>Comment: The response to Comment T40 of the first NOD states, “The cross sections for Channel 1, 6, 7 and 8 will be provided with the second round of TCEQ comments.” Provide the requested information.</p> <p>Response: Cross Sections have been included in this submittal under Appendix IIIH-C.</p>

Technical NOD #2

ID	App. Part	App. Section	Location	Citation	Error Type	Deficiency Description/Resolution
T17	306	Part III	330.63(c)(1)(B)	Appendix IIIH	Incomplete	<p>Comment: The response to Comment T41 of the first NOD states, "The cross sections for Channel 1, 6, 7 and 8 will be provided with the second round of TCEQ comments." Provide the requested information.</p> <p>Response: Cross Sections have been included in this submittal under Appendix IIIH-C.</p>
T18	359	Part III	330.331(a)(2)	SDP pg8, IIIA-1	Incomplete	<p>Comment: At many locations of the current application, the clay infiltration layer in the final cover is specified to have a permeability no greater than 10E-5 cm/sec. (for example, but not limited to, Section 2.3.1 of Appendix IIIC-A, Section 2.3.2 of Appendix IIID). The application (including, but not limited to, Table 4-1 on Page IIIA-3, Figure IIIA-A.6) specifies a permeability of 1x10E-7 cm/sec. for the liner system (no geomembrane included). Rule 330.457(a)(2) states, "For MSW landfill units with no synthetic bottom liner, the clay-rich soil cover layer shall consist of a minimum of 18 inches of earthen material with a coefficient of permeability less than or equal to the permeability of any constructed bottom liner or natural subsoil present." Revise the application (including, but not limited to, Table 4-1 on Page IIIA-3, Figure IIIA-A.6) to specify a compliant permeability for the final cover. Revise other relevant portions of the application as necessary (including, but not limited to, Closure Plan, Closure Cost Estimates).</p> <p>Response: The following pages have been updated to adjust the permeability: Page III-11 Table 4-3 Page III-A-3 Table 4-1 Figure III-A-A.6-Details A and B Page III-C-A-3 Part 2.3.5 Page III-C-A-4 HELP Model Summary-Infiltration Layer-Hydraulic Conductivity Page III-C-A-5-HELP Model Summary-Infiltration Layer-Hydraulic Conductivity Page IIIC-A-31 to IIIC-A-37 HELP model for the closed condition has been updated Page IIIC-A-69 to IIIC-A-75 HELP model for the closed condition has been updated Page IIIE-2-Section 2.2 Appendix IIIE - TCEQ Form 20720 page 3 Page IIIK-A-3 Page IIIL-4 Section 3.3 Page IIIL-11-Section 4.7.1 Page IIIN-15</p>

Technical NOD #2

ID	App. Part	App. Section	Location	Citation	Error Type	Deficiency Description/Resolution
T19	374	Part III	330.333	Appendix IIIC	Incomplete	<p>Comment:</p> <p>a)Revise Table 3-3 in Section 3.4 and Section 3.1.1 of Appendix IIIC to address Comment T44(b). The Table specifies a 30-cm leachate depth as the design and operation standard for the leachate collection and removal system per 330.331(a)(2). Note that the liner system is an alternative liner system and is designed in accordance with 330.331(a)(1). Revise the design and operation standard for the leachate collection and removal system to be consistent with the conditions established in the alternative liner design (Appendix IIIC). Remove the reference of the EPA guidance from Table 3-3. Revise other relevant portions of the application as necessary.</p> <p>b) If the maximum leachate depth on the liner determined per the above comment is greater than 30-cm, use 30-cm as the maximum depth for the operation and maintenance of the leachate collection and removal system.</p> <p>c)To demonstrate compliance with 330.333(3) and better ensure the leachate level is below the sump lip as specified in Table 3-3 of Appendix IIIC, revise Table 3-3 in Appendix IIIC by replacing “at least 4 times per month” with “at least 1 time per week.” Revise other relevant portions of the application accordingly.</p> <p>Response:</p> <p>a) The rule reference to 330.331(a)(2) has been updated on the following pages (IIIC-3,IIIC-8, and IIIC-9). The EPA reference has been removed from Table 3-3 (page IIIC-9). Table 3-3 has also been updated to match the conditions established in the alternative liner design (Appendix IIIC).</p> <p>b) Noted. The maximum leachate depth on the liner determined per the above comment is less than 30-cm.</p> <p>c) Table 3-3 has been revised as requested.</p>
T20	376	Part III	330.333(A)-(G)	Appendix IIIG	Incomplete	<p>Comment: The submitted redline-strikeout of Appendix IIIG shows a number of revisions. Address the following comments on Appendix IIIG.</p> <p>a)The TCEQ forms, Table 1-1 (Closure Cost Estimates) and Table 1-2 (Post-closure Cost Estimates) in the electronic format submittal are different than the ones in the hard copy submittal. For example, but not limited to, Total Closure Cost is \$3,377,321.39 in the hard copy form, but \$3,173,736.98 in the electronic version. Explain and/or correct the discrepancies. Also ensure that information listed in the TCEQ cost estimate forms is consistent with the information contained in the tables.</p> <p>b) The tables of the electronic format include unit costs and explanations of how the unit costs are determined. Ensure the (final) tables contain a column for unit costs and have footnotes explaining how the unit costs are determined.</p> <p>c) For the closure cost estimate form and the post-closure cost estimate form, ensure that the total cost on Page 1 and the total cost on the last page of the same form are consistent.</p> <p>d) For the post-closure cost estimate form, the total cost entered on Page 1 must be the same as the 30-year total cost listed on the last page of the form. The hard copy version of the form, for example, lists the total cost at \$2,269,302.30, while the 30-year total cost is \$68,079,069.00 on the last page of the form. Revise as necessary.</p>

Technical NOD #2

ID	App. Part	App. Section	Location	Citation	Error Type	Deficiency Description/Resolution
						<p>Response:</p> <p>a) The hard copy is correct. The online copy has been updated to match the hard copy.</p> <p>b) The final tables contain a column for unit costs with footnotes.</p> <p>c) The closure cost estimate (TCEQ Form 20721) has been reviewed and verified that the total cost on page 1 matches the total cost on the last page, no additional changes need to be made. The post-closure cost estimate (TCEQ Form 70723) page 9 has been revised to match the total cost on the first page of the form.</p> <p>d) The post-closure cost estimate (TCEQ Form 70723) page 9 has been revised to match the total cost on the first page of the form.</p>
T21	494	Part III	330.63(e)(4)(G)	IIIJ	Incomplete	<p>Comment: The cross-sections were revised to show the proposed horizontal limits of excavation; however, the proposed vertical subgrade limits of excavation were not included. Revise the cross-sections as needed.</p> <p>Response: The cross-sections have been revised to show the proposed and permitted excavation. In addition, in the existing landfill Ares the approximate "existing grade" prior to excavation has also been added to the cross section.</p>
NT22	550	Part III	330.401(a)- (c)		Inconsistent	<p>Comment:</p> <p>a) Appendix IIIN Figure 2.1, Site Plan, was not included in the NOD1 response but was referenced. Please include Figure 2.1 Site Plan in your response and include it in the Table of Contents for Appendix IIIN.</p> <p>b) Add Figure 3.1 located on Page IIIN-4 back into the Table of Contents for Appendix IIIN.</p> <p>c) Revise figure names in the IIIN Table of Contents to indicate they are located in Appendix IIIN and not "I&II IIIN".</p> <p>Response:</p> <p>a) Appendix IIIN Figure 2.1 Site Plan has been included in this submittal (permit page - 1814a).</p> <p>b) The TOC has been updated to include Figure 3.1 reference.</p> <p>c) The TOC has been updated to correct figure name.</p>
NT23	762	Part IV	330.121(a)	Section 2, Page IV-2	Inconsistent	<p>Comment:</p> <p>a) Table 35-1 was resubmitted as requested and added to the Table of Contents, however, it was noted that the page number for Table 35-1 is incorrect. Revise the Part IV SOP Table of Contents to reflect the correct page number for Table 35-1.</p> <p>b) Revise the submitted table to have "Table 35-1" somewhere on the page.</p> <p>Response:</p> <p>a) The page number for Table 35-1 has been updated in the Table of Contents (page IV-iii)</p> <p>b) The text "Table 35-1" has been added as part of the table title.</p>

CITY OF DEL RIO LANDFILL

VAL VERDE COUNTY, TEXAS
TCEQ PERMIT NO. MSW-207C

MAJOR PERMIT AMENDMENT APPLICATION PART I

Prepared for
City of Del Rio

September 2023
Revision 1 March 2024
Revision 2 July 2024
[Revision 3 March 2025](#)



Prepared by
CP&Y, an STV company
TPBE Registration No. F-1741
13155 Noel Road, Suite 200
Dallas, TX 75240
214-638-0500

This document is intended for permitting purposes only.

CITY OF DEL RIO LANDFILL

VAL VERDE COUNTY, TEXAS

TCEQ PERMIT NO. MSW-207C

MAJOR PERMIT AMENDMENT APPLICATION

PART I

CONTENTS

TCEQ PART I FORM

CORE DATA FORMS

CITY OF DEL RIO

PLATFORM WASTE SOLUTIONS LLC

PLAIN LANGUAGE FORMS

ENGLISH

SPANISH

PUBLIC INVOLVEMENT PLAN FORM

MAILING LABELS



TCEQ PART I FORM



Texas Commission on Environmental Quality

Part I Application Form for New Permit, Permit Amendment, or Registration for a Municipal Solid Waste Facility

Application Tracking Information

Facility Name: City of Del Rio Landfill

Permittee or Registrant Name: City of Del Rio

MSW Authorization Number: 207C

Initial Submission Date: 03/04/2024

Revision Date: 03/07/2025

Instructions for completing this Part I Application Form are provided in [TCEQ 00650-instr](#)¹. Include a [Core Data Form \(TCEQ 10400\)](#)² with the application for the facility owner, and another Core Data Form for the operator if different from the owner. If you have questions, contact the Municipal Solid Waste Permits Section by email to mswper@tceq.texas.gov, or by phone at 512-239-2335.

Application Data

1. Submission Type

Initial Submission Notice of Deficiency (NOD) Response

2. Authorization Type

Permit Registration

3. Application Type

New Permit

Permit Major Amendment Permit Limited Scope Major Amendment

New Registration

¹ www.tceq.texas.gov/downloads/permitting/waste-permits/msw/forms/00650-instr.pdf

² www.tceq.texas.gov/goto/coredata

4. Application Fee**Amount**

- \$2,050—New Landfill Permits, and Landfill Permit Major Amendments Described in 30 TAC [305.62\(j\)\(1\)](#)
- \$150—Other Permits, Landfill Limited Scope Major Amendments, Permit Amendments for Storage and Processing Facilities, and Registrations

Payment Method

- Check
- Online through ePay portal www3.tceq.texas.gov/epay/

If paid online, enter ePay Trace Number: 582EA000603033

5. Application URL

For applications other than those for arid exempt landfills, provide the URL address of a publicly accessible internet web site where the application and all revisions to the application will be posted.

http://www.cpypermits.com

6. Party Responsible for Publishing Notice

Indicate who will be responsible for publishing notice:

- Applicant Agent in Service Consultant

Contact Name: Gregory Velazquez

Title: Public Works Director Phone: 830-774-8535

Email Address: gvelazquez@cityofdelrio.com

7. Alternative Language Notice

Use the Alternative Language Checklist on Public Notice Verification Form TCEQ-20244-Waste-NORI, TCEQ-20244-Waste-NAPD, or TCEQ-20244-Waste-NAORPM available at www.tceq.texas.gov/permitting/waste_permits/msw_permits/msw_notice.html to determine if an alternative language notice is required.

Is an alternative language notice required for this application?

- Yes No

Indicate the alternative language: Spanish

Permit or Approval	Received	Pending	Not Applicable
Ocean Dumping Permits under Marine Protection Research and Sanctuaries Act			X
Dredge or Fill Permits under Clean Water Act			X
Licenses under the Texas Radiation Control Act			X
Other (describe): TCEQ Air Quality Permit/Registration	X		
Other (describe):			

12. Facility General Information

Facility Name: City of Del Rio Landfill

Contact Name: Shawna Burkhart Title: City Manager

MSW Authorization Number (if existing): 207C

Regulated Entity Reference Number: **RN** 102143294

Physical or Street Address (if available): 1897 Railway Ave.

City: Del Rio County: Val Verde State: TX Zip Code: 78840

Phone Number: 830-774-8558

Latitude (Degrees, Minutes Seconds): 29° 21' 20.4241"

Longitude (Degrees, Minutes Seconds): -100° 51' 13.9300"

Benchmark Elevation (above mean sea level): 1051.10 feet

Description of facility location with respect to known or easily identifiable landmarks:
 The landfill is located south of US-90, approximately 2.5 miles west of the intersection of US-90 and Loop 79, and approximately 2.25 miles east of the intersection of US-90 and US-277. The site entrance is located on Railway Ave after the intersection of S Longoria St and E Virginia St.

Access routes from the nearest United States or state highway to the facility:
 The site is accessed via US-90. US-90 intersects E Bowie St, northwest of the landfill. From this intersection, vehicles will travel southwest on E Bowie St to S Longoria St and travel east on S Longoria St. In approximately 500 feet the road S Longoria St becomes the site entrance road Railway Ave to the facility.

Coastal Management Program

Is the facility within the Coastal Management Program boundary?
 Yes No

17. Facility Contact Information**Site Operator (Permittee or Registrant)**

Name: City of Del Rio
Customer Reference Number: **CN** 600756290
Contact Name: Shawna Burkhart Title: City Manager
Mailing Address: 114 W. Martin St.
City: Del Rio County: Val Verde State: TX Zip Code: 78840
Phone Number: 830-774-8558
Email Address: shawna.burkhart@cityofdelrio.com
Texas Secretary of State (SOS) Filing Number: _____

Operator (if different from Site Operator)

Name: Platform Waste Solutions LLC
Customer Reference Number: **CN** 606151371
Contact Name: Laken Burpo Title: General Manager
Mailing Address: 833 SW Lemans
City: Lee Summit County: Jackson State: MO Zip Code: 64082
Phone Number: 731-446-2436
Email Address: laken@platform-waste.com
Texas Secretary of State (SOS) Filing Number: 804609048

Consultant (if applicable)

Firm Name: CP&Y an STV company
Consultant Name: CP&Y an STV company
Texas Board of Professional Engineers Firm Registration Number: F-1741
Contact Name: Tewobista Metaferia, P.E. Title: Project Engineer
Mailing Address: 13155 Noel Road, Suite 200
City: Dallas County: Dallas State: TX Zip Code: 75240
Phone Number: (214)-589-6944
Email Address: tewobista.metaferia@stvinc.com

Agent in Service (required for out-of-state applicants)

Name: Not Applicable
Mailing Address: _____
City: _____ County: _____ State: TX Zip Code: _____
Phone Number: _____
Email Address: _____

Signature Page

Site Operator or Authorized Signatory

I certify under penalty of law that this document and all attachments were prepared under my direction or supervision in accordance with a system designed to assure that qualified personnel properly gather and evaluate the information submitted. Based on my inquiry of the person or persons who manage the system, or those persons directly responsible for gathering the information, the information submitted is, to the best of my knowledge and belief, true, accurate, and complete. I am aware there are significant penalties for submitting false information, including the possibility of fine and imprisonment for knowing violations.

Name: Shawna D. Burkhart Title: City Manager

Email Address: shawna.burkhart@cityofdelrio.com

Signature: Shawna D Burkhart Date: 3/13/25

Operator or Principal Executive Officer Designation of Authorized Signatory

To be completed by the operator if the application is signed by an authorized representative for the operator.

I hereby designate Shawna D. Burkhart as my representative and hereby authorize said representative to sign any application, submit additional information as may be requested by the Commission; and/or appear for me at any hearing or before the Texas Commission on Environmental Quality in conjunction with this request for a Texas Water Code or Texas Solid Waste Disposal Act permit. I further understand that I am responsible for the contents of this application, for oral statements given by my authorized representative in support of the application, and for compliance with the terms and conditions of any permit which might be issued based upon this application.

Operator or Principal Executive Officer Name: Shawna D. Burkhart

Email Address: shawna.burkhart@cityofdelrio.com

Signature: Shawna D Burkhart Date: 3/13/25

Notary

SUBSCRIBED AND SWORN to before me by the said Shawna D. Burkhart

On this 13th day of March, 2025

My commission expires on the 03 day of 11, 2027

Manil

Notary Public in and for Val Verde County, Texas

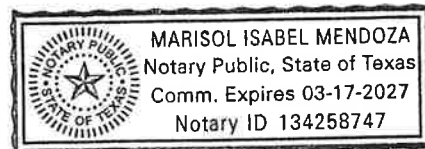

Note: Application Must Bear Signature & Seal of Notary Public

CORE DATA FORMS

City of Del Rio

<input type="checkbox"/> Dam Safety	<input type="checkbox"/> Districts	<input type="checkbox"/> Edwards Aquifer	<input type="checkbox"/> Emissions Inventory Air	<input type="checkbox"/> Industrial Hazardous Waste
<input checked="" type="checkbox"/> Municipal Solid Waste	<input type="checkbox"/> New Source Review Air	<input type="checkbox"/> OSSF	<input type="checkbox"/> Petroleum Storage Tank	<input type="checkbox"/> PWS
<input type="checkbox"/> Sludge	<input type="checkbox"/> Storm Water	<input type="checkbox"/> Title V Air	<input type="checkbox"/> Tires	<input type="checkbox"/> Used Oil
<input type="checkbox"/> Voluntary Cleanup	<input type="checkbox"/> Wastewater	<input type="checkbox"/> Wastewater Agriculture	<input type="checkbox"/> Water Rights	<input type="checkbox"/> Other:

SECTION IV: Preparer Information

40. Name:	Tewobista Metaferia	41. Title:	Project Manager
42. Telephone Number	43. Ext./Code	44. Fax Number	45. E-Mail Address
(214) 589-6944		(214) 638-3723	tewobista.metaferia@stvinc.com

SECTION V: Authorized Signature

46. By my signature below, I certify, to the best of my knowledge, that the information provided in this form is true and complete, and that I have signature authority to submit this form on behalf of the entity specified in Section II, Field 6 and/or as required for the updates to the ID numbers identified in field 39.

Company:	City of Del Rio	Job Title:	City Manager
Name (In Print):	Shawna Burkhart	Phone:	(830) 774- 8558
Signature:		Date:	3/13/25

CITY OF CITY OF DEL RIO LANDFILL

VAL VERDE COUNTY, TEXAS
TCEQ PERMIT NO. MSW-207C

MAJOR PERMIT AMENDMENT APPLICATION PART I/II – GENERAL APPLICATION REQUIREMENTS

Prepared for
City of Del Rio

September 2023
Revision 1 August 2024
[Revision 2 March 2025](#)



Prepared by
CP&Y an STV Company
TPBE Registration No. F-1741
13155 Noel Road, Suite 200
Dallas, TX 75240
214-638-0500

This document is intended for permitting purposes only.

TABLE OF CONTENTS

LIST OF ACRONYMS	I/II-iv
1.0 INTRODUCTION	I/II-1
2.0 SUPPLEMENTARY TECHNICAL REPORT	I/II-3
2.1 Facility Location and Project Overview.....	I/II-3
2.1.1 Site Location	I/II-3
2.1.2 Owner and Operator	I/II-3
2.1.3 Major Permit Amendment Summary	I/II-3
2.1.4 Waste Acceptance Plan	I/II-3
2.1.5 Disposal Rate and Volume of Waste	I/II-5
2.1.6 Solid Waste Containment System	I/II-6
2.1.7 Site Development Plan	I/II-6
2.1.8 Site Monitoring Systems.....	I/II-7
2.1.9 Site Operations	I/II-7
2.2 Regulatory Agency Coordination	I/II-8
2.3 Texas Historical Commission Review.....	I/II-8
2.4 Middle Rio Grande Development Council	I/II-8
2.5 Abandoned Oil and Water Wells	I/II-8
2.6 Internet Posting	I/II-9
2.7 Existing Permits/Authorizations	I/II-9
3.0 EXISTING CONDITIONS SUMMARY	I/II-13
3.1 Site History.....	I/II-13
3.2 Existing Liner System	I/II-13
3.3 Landfill Gas Monitoring System	I/II-13
3.4 Groundwater Monitoring System.....	I/II-13
4.0 MAPS	I/II-16
5.0 PROPERTY OWNERS LIST AND MAP	I/II-20
6.0 AERIAL PHOTOGRAPH	I/II-24
7.0 LAND USE	I/II-26
7.1 Character of Surrounding Land and Land Use	I/II-26
7.2 Location and Zoning.....	I/II-26
7.3 Surrounding Land Use.....	I/II-26
7.4 Growth Trends of the Nearest Communities.....	I/II-26
7.5 Proximity to Residences and Other Uses.....	I/II-27
7.6 Land Use Conclusions	I/II-27
7.7 Water Wells Within 500 Feet.....	I/II-27
8.0 TRANSPORTATION	I/II-33
8.1 Traffic Information.....	I/II-33



8.1.1 Availability and Adequacy of Roads I/II-33

8.2 Airport Impact..... I/II-34

9.0 GENERAL GEOLOGY AND SOILS STATEMENT I/II-36

9.1 Geology and Soils..... I/II-36

9.2 Fault Lines I/II-36

9.3 Seismic Impact Zone I/II-36

9.4 Unstable Areas..... I/II-36

10.0 GROUNDWATER AND SURFACE WATER STATEMENT I/II-38

10.1 Groundwater Statement..... I/II-38

10.2 Surface Water Statement I/II-38

11.0 FLOODPLAINS AND WETLANDS STATEMENT I/II-39

11.1 Floodplains Statement..... I/II-39

11.2 Wetlands Statement..... I/II-39

12.0 PROTECTION OF ENDANGERED SPECIES I/II-41

13.0 LEGAL DESCRIPTION..... I/II-42

14.0 PROPERTY OWNER AFFIDAVIT..... I/II-47

15.0 LEGAL AND SIGNATORY AUTHORITY..... I/II-49

16.0 EVIDENCE OF COMPETENCY I/II-51

16.1 Experience..... I/II-51

16.2 City of Del Rio Landfill Key Personnel I/II-51

16.2.1 City Manager I/II-52

16.2.2 Public Works Director/City Engineer I/II-52

16.2.3 Rene Maldonado, Landfill Coordinator I/II-52

16.2.4 Chris Bix, Chief Executive Officer – Platform Diversified Logistics I/II-52

16.2.5 Kenny McCarty, Sr. Operations Manager – Platform Waste Solutions I/II-53

16.2.6 Jose Huerta, General Manager – Platform Waste Solutions, Del Rio Office I/II-53

16.3 Equipment..... I/II-53

- APPENDIX I/IIA: FACILITY LAYOUT FIGURES**
- APPENDIX I/IIB: COORDINATION DEMONSTRATION**
- APPENDIX I/IIC: LOCATION RESTRICTION DEMONSTRATION**
- APPENDIX I/IID: TPDES PERMIT**
- APPENDIX I/IIE: TCEQ FORMS**



LIST OF TABLES

Table 2-1 Waste Disposal Capacity Summary..... I/II-5
 Table 2-2 Waste Inflow Summary..... I/II-5
 Table 2-3 Projected Maximum Annual Waste Acceptance I/II-6
 Table 2-4 Existing Permits/Authorizations..... I/II-10
 Table 5-1 Property Owners List..... I/II-21
 Table 5-2 Easement Holders Associated within The Permit Boundary I/II-22
 Table 7-1 Population Growth Trends..... I/II-27
 Table 8-1 Traffic Growth Trends I/II-33

LIST OF FIGURES

Figure I&II 1.1 – Existing Site Plan..... I/II-2
 Figure I&II 2.1 – Permitted and Proposed Landfill Completion Plan I/II-11
 Figure I&II 2.2 – Permitted and Proposed Landfill Excavation Plan..... I/II-12
 Figure I&II 3.1 – Permitted Final Cover Plan..... I/II-14
 Figure I&II 3.2 – Permitted Excavation Plan I/II-15
 Figure I&II 4.1 – Site Location Map..... I/II-17
 Figure I&II 4.2 – General Topographic Map..... I/II-18
 Figure I&II 4.3 – Structures and Inhabitable Building within 500 Feet I/II-19
 Figure I&II 5.1 – Property Owners Map I/II-23
 Figure I&II 6.1 – Aerial Photograph..... I/II-25
 Figure I&II 7.1 – Land Use Map-Aerial I/II-28
 Figure I&II 7.2 – Land Use Map..... I/II-29
 Figure I&II 7.3 – Cities within 5 Mile Radius I/II-30
 Figure I&II 7.4 – Water Well Map I/II-31
 Figure I&II 7.5 – Zoning Map..... I/II-32
 Figure I&II 8.1 – Area Airports I/II-35
 Figure I&II 11.1 – Flood Insurance Rate Map (FIRM)..... I/II-40



destruction or adverse modification of a critical habitat, protected under the Endangered Species Act of 1973, or violate any requirement under the Marine Protection, Research, & Sanctuaries Act of 1972 for the protection of marine sanctuary.

11.0 FLOODPLAINS AND WETLANDS STATEMENT

11.1 Floodplains Statement

As shown on Figure I/II-11.1, the existing landfill permit boundary is not located within the 100-year floodplain as defined by the Federal Emergency Management Agency (FEMA), Flood Insurance Rate Map (FIRM) for Val Verde County, Texas and incorporated areas.

Compliance with the floodplain location restriction is further discussed in Appendix I/IIC.

11.2 Wetlands Statement

The area within the permit boundary of the City of Del Rio Landfill was evaluated for compliance with wetlands provisions, including the determination and identification requirements in Title 30 TAC §330.61(m)(2) and (3) and the wetlands location restriction in §330.553(b). Although there are wetlands within the permit boundary of the City of Del Rio Landfill, the limit of waste is not located in wetlands.

The USACE has reviewed this project under the pre-construction notification procedures of Nationwide Permit General Condition 32 Federal Register, Vol. 86, No. 8, Wednesday. It was determined the discharge of dredged or fill materials into waters of the United States associated with this project appears to qualify for Nationwide Permit (NWP) 39 for Commercial and Institutional Developments. The permit approval letter is included in Appendix I/IIB. ~~There will be some areas of the wetlands that will be filled for channel and road grading. The water areas that will be filled will be less than one-tenth of an acre at any single and complete crossing and would therefore be covered by the Nationwide Permit (NWP) 14 for linear transportation projects without notifying the USACE.~~ The project will adhere to all requirements outlined in NWP ~~39~~14. In addition, all activities will comply with the water quality certification conditions of TCEQ. No waste will be placed within the wetland areas: therefore, the site is in compliance with the wetland's location restriction.

12.0 PROTECTION OF ENDANGERED SPECIES

A written request regarding endangered or threatened species or their critical habitat with respect to the site was sent to the U.S. Fish and Wildlife Service (FWS) and the Texas Parks and Wildlife Department (TPWD). Correspondence with the FWS and TPWD is included in Appendix I/IIB. In addition, a site specific threatened and endangered species habitat assessment was completed by CP&Y (refer to the TPWD and FWS in Appendix I/IIB). Based on this study the TPWD has issued comments and recommendation listed in the following sections. The listed recommendations will prevent and minimize ~~concluded that the area within the landfill permit boundary does not provide habitat for nor has critical habitat been designated in the project area for any federally listed threatened or endangered species. Therefore, it is concluded that the expansion of the City of Del Rio Landfill will not result in~~ the destruction or adverse modification of the critical habitat of any federally listed threatened or endangered species, or cause or contribute to the taking of any federally listed threatened or endangered species. Given the above, the facility is in compliance with all applicable federal, state, and local laws regarding threatened or endangered species.

12.1 Construction Recommendations

During construction in the expansion area:

- Sediment control fence for the purpose of controlling erosion and protecting water quality on the downstream side of the construction area per the SWPPP.
- Site will be secured at the end of each day and check for wildlife that may need safe egress opportunities.
- Authorized individual will be available to translocate and handle any rare or state listed species that will not readily leave the work area to the proper distance and location.
- Erosion and seed/mulch stabilization material along with no-till drilling, hydromulching and/or hydroseeding when revegetation efforts may be needed to reduce the risk of wildlife entanglement hazard.
- If erosion control blankets or mats made of netting will be used and designed to TPWD standards to avoid wildlife entanglement.

12.2 Federal and State Regulations

The following TPWD recommendations will be followed during construction to meet the federal and state regulations.

- When practicable and necessary to comply with applicable laws and regulations, clearing of vegetation will take place outside of the general bird nesting season, March 15 through September 15. A qualified biologist will conduct nest surveys for active nests within nesting season when any vegetation is to be impacted. The recommended buffers will be implemented and remain in place for the appropriate amount of time when nests are observed to be inactive.
- Current TPWD annotated county list of rare species for Val Verde County was reviewed and construction contractor will be aware of listed rare species.
- Disturbance of the Texas horned lizard, its habitat, and primary food source. It will not be feasible for a biological monitor to be present during construction, but the Texas horned

lizard will be allowed to safely leave the site on their own. It should be noted that harvester ants or their nests were not noted during the multiple field observations.

- BMPs will be used during times the Texas tortoise is active. It will not be feasible for a biological monitor to be present during all vegetation clearing, but if a Texas tortoise is located in imminent danger during clearing or construction it will be transported to the closest suitable habitat. Exclusion fences will be constructed per the general construction recommendations.
- Proper surveys will be conducted for any ground disturbing activities after the month of October. If tortoise or indications of tortoise presence is observed TPWD Ecological and Environmental Planning Program staff will be contacted.

13.0 LEGAL DESCRIPTION

A legal description of the 180.6-acre permit boundary is included on the following pages. This area is shown on the attached drawing.

The City of Del Rio has 100% ownership of the landfill. Current ownership records for the property may be found in Val Verde County Real Property records.

PROPERTY OWNER’S AFFIDAVIT

On this day, _____, appeared before me, the undersigned notary public, and after I administered an oath to him, upon this oath he said:

“My name is _____. I am the ~~Interim~~ City Manager of the City of Del Rio, and I am authorized to make the following statements on behalf of the City of Del Rio.

The City of Del Rio is the owner of certain real property in Val Verde County, Texas, included the tract(s) described in Exhibit A attached hereto (“the Property”), which is included in the permitted area of its Del Rio Landfill municipal solid waste landfill facility (“the Facility”), pursuant to amendment of Texas Commission on Environmental quality Permit No. MSW-207C.

The City of Del Rio hereby acknowledges that the State of Texas may hold the property owner of record either jointly or severally responsible for the operation, maintenance, and closure and post-closure care of the Facility on the Property.

The City of Del Rio hereby acknowledges that the owner of the Property has the responsibility to file in the deed records of Val Verde County an affidavit to the public advising that the Property will be used for a solid waste facility prior to the time that the Facility actually begins operating as a municipal solid waste landfill facility on the Property, and to file a final recording upon completion of disposal operations and closure of the landfill units on the Property in accordance with 30 TAC §330.19.

The City of Del Rio hereby acknowledges that the Facility owner or operator and the State of Texas shall have access to the Property during the active life and post-closure care of the Facility for the purpose of inspection and maintenance.

~~Shawna Burkhart~~ ~~Manuel Chavez~~
~~Interim~~-City Manager
City of Del Rio

SWORN TO AND SUBSCRIBED before me by _____ on the _____ day of _____, 2025~~4~~.

Notary Public

DELEGATED SIGNATORY AUTHORITY

Tony Baker
Executive Director
Texas Commission on Environmental Quality
P.O. Box 13087
Austin, Texas 78711-3087

Dear Mr. Baker:

I am an Authorized Agent of the City of Del Rio.

I certify under penalty of law that this document and all attachments were prepared under my direction or supervision in accordance with a system designed to assure that qualified personnel properly gather and evaluate the information submitted. Based on my inquiry of the person or persons who manage the system, or those persons directly responsible for gathering the information, the information submitted is, to the best of my knowledge and belief, true, accurate, and complete. I am aware there are significant penalties for submitting false information, including the possibility of fine and imprisonment for knowing violations.

Sincerely,

Shawna Burkhardt~~Manuel Chavez~~
~~Interim~~ City Manager

SWORN TO AND SUBSCRIBED BEFORE ME by _____ on the _____ day
of _____, 202~~5~~³, which witness my hand and seal of office.

Notary Public in and for the State of Texas

Printed Name

My Commission Expires _____

CITY OF CITY OF DEL RIO LANDFILL

VAL VERDE COUNTY, TEXAS
TCEQ PERMIT NO. MSW-207C

MAJOR PERMIT AMENDMENT APPLICATION PARTS I/II – GENERAL APPLICATION REQUIREMENTS

APPENDIX I/II B COORDINATION DEMONSTRATION

Prepared for
City of Del Rio

Revision 1 August 2024
[Revision 2 March 2025](#)



Prepared by
CP&Y an STV company
TPBE Registration No. F-1741
13155 Noel Road, Suite 200
Dallas, TX 75240
214-638-0500

This document is intended for permitting purposes only.

TABLE OF CONTENTS

COORDINATION WITH FEDERAL AVIATION ADMINISTRATION.....I/IIB-1
COORDINATION WITH TEXAS HISTORICAL COMMISSION.....I/IIB-47
COORDINATION WITH TEXAS DEPARTMENT OF TRANSPORTATION.....I/IIB-131
COORDINATION WITH TEXAS PARKS AND WILDLIFE DEPARTMENT.....I/IIB-142
COORDINATION WITH U.S. ARMY CORPS OF ENGINEERS.....I/IIB-202
COORDINATION WITH U.S. DEPARTMENT OF THE INTERIOR FISH AND WILDLIFE SERVICE.....I/IIB-345
COORDINATION WITH MIDDLE RIO GRANDE DEVELOPMENT COUNCIL.....I/IIB-405



COORDINATION WITH FEDERAL AVIATION ADMINISTRATION

- [September 12, 2024](#) FAA Determination of No Hazard to Air Navigation Letter ~~has not been received yet~~.
- August 14, 2024 Request for Review Letter regarding hazards to air navigation and hazards to air traffic due to birds.
- [Del Rio International Airport notification letter](#).
- [Laughlin Air Force Base notification letter](#).



U.S. Department
of Transportation
**Federal Aviation
Administration**

Federal Aviation Administration
Southwest Region, Airports Division
Safety and Standards Branch

10101 Hillwood Parkway
Fort Worth, Texas 76177

September 12, 2024

Tewobista Metaferia, P.E.
Engineer, Water Practice
Tewobista.Metaferia@stvinc.com

**Subject: City of Del Rio Landfill
Type I Landfill – Amendment Application
Proposed Amendment Horizontal Expansion (1034' AMSL)
FAA File No. 2020-003-TX**

Dear Tewobista Metaferia:

This letter is in response to your August 14, 2024 email advising us of the proposed horizontal expansion of the Del Rio Landfill. FAA Airspace Procedures evaluated the request for the horizontal expansion and set height restriction at 1034 AMSL. On August 14, 2024, the FAA forwarded a “Determination of No Hazard to Air Navigation” Letter to the Public Works Director for the City of Del Rio.

Using coordinates 29 21’ 34.60” N and 100 51’ 48.04” W, we determined there is one public-use airport 3.46 nm (Del Rio International) from the site boundary with the approach end of Runway 31 west northwest of the Landfill site. We also determined there is a military airport 4.48 nm (Laughlin Air Force Base) due east of the Landfill site. A 14 CFR Part 77 evaluation revealed no potential conflicts.

The Del Rio Landfill site was previously evaluated by FAA in 1989, 1994 and 2020 without objection. We have no objection to the proposed horizontal expansion of the Del Rio Landfill site. The current wildlife mitigation strategies are working well. In the event that these strategies become less effective in wildlife control please contact our office and we can assist. Our position of no objection is based on the application of our guidance for hazardous wildlife attractants on or near airports FAA Advisory Circular 150/5200-33C.

This site has been assigned our file No. 2020-003-TX. Please refer to this number in any future correspondence regarding this site. Thank you for coordinating this project with us. If there are any questions, you can contact me at 817-222-5671 or gary.loftus@faa.gov.

Sincerely,

**GARY J
LOFTUS**

Digitally signed by GARY
J LOFTUS
Date: 2024.09.12
11:03:30 -05'00'

Gary J. Loftus, A.A.E.
Airports Compliance Program Manager
Airport Certification Safety Inspector
FAA Southwest Region Airports Division

COORDINATION WITH TEXAS DEPARTMENT OF TRANSPORTATION

- [September 24, 2024](#), TXDOT conclusion of no objections or concerns with potential traffic impact letter ~~has not been received yet~~.
- [July 5, 2024](#), Request for Review Letter.



1817 Bob Bullock Loop | Laredo, Texas 78043
956-712-7400
txdot.gov

Permit Page - 231

September 24, 2024

Ms. Tewobista Metaferia P.E.
Project Manager
STV
13155 Noel Road, Suite 200
Dallas, Texas 75240

Re: Compliance with Traffic Location Restriction Information
Proposed City of Del Rio Municipal Landfill Permit Amendment
Val Verde County, Texas

Dear Ms. Metaferia:

We appreciate STV notifying us of the expansion of the municipal solid waste facility in Del Rio, Texas. The District has reviewed the site location map and the details provided in the notification letter. We do not have any objections or concerns with potential traffic impact to the highway facility.

Please let us know if additional information is required from TxDOT.

Sincerely,

DocuSigned by:

A5A9883ECD1E4F7...

Epigmenio Gonzalez, P.E.
Laredo District Engineer

cc: Hyung Ahn, Del Rio Area Engineer

COORDINATION WITH TEXAS PARKS AND WILDLIFE DEPARTMENT

- [October 2, 2024 – Response Letter to TPWD on recommendations.](#)
- [May 24, 2024](#) TPWD ~~conclusion of no anticipated significant adverse impacts to rare, threatened or endangered species or other fish and wildlife resources~~[response](#) letter ~~has not been received yet.~~
- July 5, 2024, Request for Review Letter.



October 2, 2024

Mr. Russell Hooten
Ecological and Environmental Planning
Program
Wildlife Division
Texas Parks and Wildlife Department
4200 Smith School Road
Austin, Texas 78744

via email: russell.hooten@tpwd.texas.gov

Re: Texas Parks and Wildlife Department Comments on the Proposed expansion of the City of Del Rio Landfill (Proposed Permit No 207C), Del Rio, Val Verde County, Texas

Dear Mr. Hooten,

STV Inc. (STV) has reviewed the Texas Parks and Wildlife Department (TPWD) comments and recommendations, dated May 24, 2024, regarding the proposed expansion of the City of Del Rio's landfill project located in Val Verde County, Texas. We appreciate your recommendations and provide the following responses.

Construction Recommendations

General Construction Recommendations

Recommendation: During development of the expansion area, TPWD recommends the judicious use and placement of sediment control fence to exclude wildlife from discrete expansion areas, when applicable. In many cases, sediment control fence placement for the purposes of controlling erosion and protecting water quality can be modified minimally to also provide the benefit of excluding wildlife access to areas being disturbed. The exclusion fence should be buried at least six inches and be at least 24 inches high. The exclusion fence should be maintained for the life of the project and should only be removed after construction is completed. Construction personnel should be encouraged to examine the inside of exclusion areas daily to determine if any wildlife species have been trapped inside the areas of impact and provide safe egress opportunities prior to initiation of construction activities. Exclusion fences are particularly effective in preventing reptile species from entering a construction area.

STV Response: STV will specify that the construction contractor shall maintain sediment control fence for the purpose of controlling erosion and protecting water quality on the downstream side of the construction area per the Stormwater Protection Plan. Contractor to secure the site at the end of each day and check for wildlife that may need safe egress opportunities.

Recommendation: For encounters with rare species that will not readily leave the work area, TPWD recommends an authorized individual translocate the animal. Translocations of reptiles should be the minimum distance possible from the work area. Ideally, individuals to be relocated should be transported to the closest suitable habitat outside of the active construction area; preferably within 100 to 200 yards and not greater than one mile from the capture site. State listed species may only be handled by persons with appropriate authorization from the TPWD Wildlife Permits Office. For more information regarding Wildlife Permits, please contact the Wildlife Permits Office at (512) 389-4647.

COORDINATION WITH U.S. ARMY CORPS OF ENGINEERS

- [March 3, 2025 USACE Letter Issuing a Nationwide Permit 39 for the project](#)
- [January 3, 2025 Nationwide Permit request application](#)
- August 13, 2023, USACE determination that authorization pursuant to Section 404 is not required.
- August 2023, Jurisdictional Determination Report



DEPARTMENT OF THE ARMY
U.S. ARMY CORPS OF ENGINEERS, FORT WORTH DISTRICT
P. O. BOX 17300
FORT WORTH, TEXAS 76102-0300

March 3, 2025

Regulatory Division

SUBJECT: Project Number SWF-2023-00046, Del Rio Landfill Expansion Site

Mr. Gregory Velazquez
Assistant Director
City of Del Rio Public Works
114 West Martin Street
Del Rio, Texas 78440
gvelazquez@cityofdelrio.com

Dear Mr. Velazquez:

This letter is in regard to information received January 3, 2025, and subsequent information received January 30, 2025, concerning a proposal by the City of Del Rio Public Works to conduct landfill expansion activities in the city of Del Rio, Val Verde County, Texas. This project has been assigned Project Number SWF-2023-00046. Please include this number in all future correspondence concerning this project.

Under Section 404 of the Clean Water Act the U.S. Army Corps of Engineers (USACE) regulates the discharge of dredged and fill material into waters of the United States, including wetlands. USACE responsibility under Section 10 of the Rivers and Harbors Act of 1899 is to regulate any work in, or affecting, navigable waters of the United States. Based on the description of the proposed work, and other information available to us, we have determined this project will involve activities subject to the requirements of Section 404.

We have reviewed this project under the pre-construction notification procedures of Nationwide Permit General Condition 32 Federal Register, Vol. 86, No. 8, Wednesday, January 13, 2021. We have determined the discharge of dredged or fill materials into waters of the United States associated with this project appears to qualify for Nationwide Permit 39 for Commercial and Institutional Developments. To use this permit, the person responsible for the project must ensure the work is in compliance with the specifications and conditions for the permit listed above, found at <https://www.swf.usace.army.mil/Missions/Regulatory/Permitting/Nationwide-General-Permits/>. Additionally, all activities must comply with the water quality certification conditions of the Texas Commission on Environmental Quality (TCEQ) located at https://www.swf.usace.army.mil/Portals/47/docs/regulatory/Permitting/General%20Permitting/TX_401_cert.pdf?ver=rle8wtu6MRCA2s6Q4QQMg%3d%3d. Failure to comply with these specifications and conditions invalidates the authorization and may result in a violation.

COORDINATION WITH MIDDLE RIO GRANDE DEVELOPMENT COUNCIL

- July 17, 2024 letter requesting MRGDC concurrence that the landfill expansion is consistent with the Regional Solid Waste Plan
- August 27, 2024 Board of Directors draft meeting minutes approving the landfill expansion project.

**MIDDLE RIO GRANDE DEVELOPMENT COUNCIL
BOARD OF DIRECTORS MEETING
MINUTES**

**SSGT Willie de Leon Civic Center
2024
300 E Main St
Uvalde, Texas 78801**

Tuesday, August 27,

1:00 PM

Members Present:

Hon. Bella Rubio, Real County Judge
Hon. Lewis Owens, Val Verde County Judge
Hon. Martha A. Gomez Ponce, Dimmit County Judge
Hon. Frank Moreno, Mayor of Crystal City
Hon. Ramsey English-Cantu, Maverick County Judge
Hon. Cindy Martinez Rivera, Zavala County Judge
Hon. Everado Zamora, Mayor of Uvalde
Hon. Hazel Pendley, Mayor of Leakey
Dr. Hector Gonzales, Southwest Texas Junior College
Mr. Jack Alba, La Salle County Member-at-Large
Mr. Jesus Sanchez, Maverick County Member-at-Large
Mr. Joe Cardenas, Uvalde County Member-at-Large
Hon. John P. Schuster, Kinney County Judge
Dr. Jorge Garza, Sul Ross State University
Hon. Sandra Luna, Mayor of Cotulla
Hon. Leodoro Martinez III, La Salle County Judge
Ms. Otila Gonzalez, Val Verde County Member-at-Large
Commissioner Raul Gomez, Zavala County Member-at-Large
Ms. Rebecca Flores, Kinney County Member-at-Large
Dr. Rose Pearson, Carrizo Springs Superintendent Education Representative
Hon. James DeReus, City of Del Rio Councilperson-at-Large

Members Absent:

Hon. William R. Mitchell, Uvalde County Judge
Hon. Alvaro Arreola, Mayor of Del Rio
Hon. Michael Aguirre, Mayor of Brackettville
Hon. Juan Gomez, Real County Member-at-Large
Hon. Mario Dj Ruiz, Dimmit County Member-at-Large
Hon. Oscar Puente, Mayor of Carrizo Springs
Hon. Rolando Salinas, Mayor of Eagle Pass
Mr. William Davis, City of Eagle Pass Councilperson-at-Large

CITY OF CITY OF DEL RIO LANDFILL

VAL VERDE COUNTY, TEXAS
TCEQ PERMIT NO. MSW-207C

MAJOR PERMIT AMENDMENT APPLICATION PARTS I/II – GENERAL APPLICATION REQUIREMENTS

APPENDIX I/II C LOCATION RESTRICTION DEMONSTRATION

Prepared for
City of Del Rio

September 2023
Revision 1 August 2024
[Revision 2 March 2025](#)

Prepared by
CP&Y an STV Company.
TPBE Registration No. F-1741
13155 Noel Road, Suite 200
Dallas, TX 75240
214-638-0500



This document is intended for permitting purposes only.

TABLE OF CONTENT

1.0 INTRODUCTION I/IIC-1
 2.0 EASEMENTS AND BUFFER ZONES..... I/IIC-2
 3.0 AIRPORT SAFETY I/IIC-4
 4.0 FLOODPLAINS I/IIC-5
 5.0 GROUNDWATER I/IIC-6
 6.0 ENDANGERED OR THREATENED SPECIES..... I/IIC-7
 7.0 WETLANDS I/IIC-8
 8.0 FAULT AREAS I/IIC-10
 9.0 SEISMIC IMPACT ZONES I/IIC-12
 10.0 UNSTABLE AREAS..... I/IIC-14
 11.0 COASTAL AREAS..... I/IIC-16
 12.0 TYPE I AND TYPE IV LANDFILL PERMIT ISSUANCE PROHIBITED I/IIC-17

LIST OF TABLES

4-1 Floodplain Location Restriction Requirements I/IIC-4

LIST OF FIGURES

Figure I/IIC 2.1 – Buffer Zone Plan I/IIC-3
 Figure I/IIC 7.1 – US Waters and Wetlands..... I/IIC-9
 Figure I/IIC 8.1 – USGS Quaternary Fault Zone..... I/IIC-11
 Figure I/IIC 9.1 – Seismic Impact Zone Map..... I/IIC-13



7.0 WETLANDS

The area within the existing permit boundary of the City of Del Rio Landfill was evaluated for compliance with wetlands provisions, including the determination and identification requirements in Title 30 TAC §330.61(m)(2) and (3) and the wetlands location restriction in §330.553(b). The wetland delineation is shown on Figure I/IIC 7.1. Although there are wetlands within the permit boundary of the City of Del Rio Landfill, the limit of waste is not located in wetlands. There will be some areas of the wetlands that will be filled for perimeter channel and road grading. ~~The area of wetland that will be filled will be less than tenth of an acre and will be covered under a 404 Nation Wide permit during construction. No waste will be placed within the wetlands, therefore the site is in compliance with the wetlands location restriction.~~The USACE has reviewed this project under the pre-construction notification procedures of Nationwide Permit General Condition 32 Federal Register, Vol. 86, No. 8, Wednesday. It was determined the discharge of dredged or fill materials into waters of the United States associated with this project appears to qualify for Nationwide Permit (NWP) 39 for Commercial and Institutional Developments. The permit approval letter is included in Appendix I/IIB. The project will adhere to all requirements outlined in NWP 39. In addition, all activities will comply with the water quality certification conditions of TCEQ. No waste will be placed within the wetland areas: therefore, the site is in compliance with the wetland's location restriction.

CITY OF CITY OF DEL RIO LANDFILL

VAL VERDE COUNTY, TEXAS
TCEQ PERMIT NO. MSW-207C

MAJOR PERMIT AMENDMENT APPLICATION PART I/II – GENERAL APPLICATION REQUIREMENTS

APPENDIX I/II E TCEQ FORMS

Prepared for
City of Del Rio

Revision 1 August 2024
[Revision 2 March 2025](#)



Teobista Metaferia

Prepared by
CP&Y an STV company.
TPBE Registration No. F-1741
13155 Noel Road, Suite 200
Dallas, TX 75240
214-638-0500

This document is intended for permitting purposes only.

TABLE OF CONTENT

TCEQ FORM 20873 – WASTE ACCEPTANCE PLAN.....I/IIE-1
TCEQ FORM 20719 – TRANSPORTATION DATA AND REPORT FORM.....I/IIE-9



TCEQ FORM 20719

TRANSPORTATION DATA AND REPORT

FORM



Texas Commission on Environmental Quality

Transportation Data and Coordination Report Form for Municipal Solid Waste Type I Landfills

This form is for use by applicants or site operators of Municipal Solid Waste (MSW) Type I landfills to provide data and information to address the availability and adequacy of access roads to a landfill site, the volume of vehicular traffic on and generated by the facility on area roadways, and to provide coordination information as required under 30 TAC §330.61(i). Roadways that provide primary access to a landfill facility must be adequate and possess appropriate design capacity to safely accommodate the additional volumes and weights of traffic generated or expected to be generated by this landfill facility during its active life. Data provided in this form should correspond with data contained in the coordination documents submitted to the Texas Department of Transportation or other agency that has jurisdiction over affected area roads.

If you need assistance in completing this form, please contact the Municipal Solid Waste Permits Section of the Waste Permits Division at (512) 239-2335.

I. General Information

Facility Name: **City of Del Rio Landfill**

MSW Permit No.: **207C**

Site Operator/Permittee Name and Mailing Address: **City of Del Rio**
114 W Martin St., Del Rio, TX 78840

II. Documentation of Coordination with the Texas Department of Transportation (TXDOT) for Traffic and Location Restrictions

1. A traffic study document and cover letter was submitted to TXDOT as Coordination for traffic and location restrictions for the subject facility and a copy of the documents submitted to TXDOT is attached herein: Yes No

If you checked "No" , provide explanation:

2. Date of submission of the coordination documents to TXDOT: **07/05/2024**
3. TXDOT's response received? Yes No

If "No" is checked in response to Item I.3 above, complete Items I.4 and I.5 below only after TxDOT's response is received.

4. Did TxDOT's response include recommendation of improvements to any of the roadways or intersections that lead to the site? Yes No
5. If you checked "Yes" in Item I.5 above, proceed to Section III., TxDOT's Recommended Roadway or Intersection Improvements (as applicable).

Transportation Data and Coordination Report for MSW Type I Landfills

Facility Name: City of Del Rio Landfill

Revision No.: 1

Permit No: MSW-207C

Date: March 7, 2025

- 6. If you checked "No" in Item I.5 above, provide TxDOT's response to the traffic and location restrictions compliance coordination for the subject site: *(Enter TxDOT's response to coordination correspondence)* **TxDOT did not have any objections or concerns with potential traffic impact to the highway facility. Refer to Appendix I/IIB page I/IIB-132 for the TxDOT response letter.**

III. TxDOT Recommended Roadway or Intersection Improvements (as applicable)

Enter TxDOT's recommendations for improvement of roadways or intersections that lead to the site:

- 1. **None at this time**
- 2.
- 3.

IV. Documentation of Coordination of Improvement Designs of Public Roadways (turning lanes, storage lanes, acceleration/deceleration lanes, etc.) at and Near the Site Entrances with Agencies that Exercise Maintenance Responsibility

- 1. Complete Table 1 with information regarding documentation of coordination of improvement designs for existing and proposed roads.

Table 1: Public Roadway Improvements Coordination

Existing and Proposed Roads Associated with the Site Entrance(s)	Agency Exercising Maintenance Responsibility	Date of Coordination Correspondence from the Applicant or Site Operator to the Agency Responsible	Date of the Coordination Response Letter from the Agency Responsible	Did the Agency Require Improvements to the Roadway(s) Associated with the Site Entrance(s) (check Yes or No as applicable)
Railway Ave	City of Del Rio	Landfill is Owned by the City	NA	<input type="checkbox"/> Yes <input checked="" type="checkbox"/> No
US 90	TxDOT	July 5, 2024	Still waiting on response	<input type="checkbox"/> Yes <input type="checkbox"/> No
US 277	TxDOT	July 5, 2024	Still waiting on response	<input type="checkbox"/> Yes <input type="checkbox"/> No
				<input type="checkbox"/> Yes <input type="checkbox"/> No

Transportation Data and Coordination Report for MSW Type I Landfills

Facility Name: City of Del Rio LandfillRevision No.: 1Permit No: MSW-207C

Date: March 7, 2025

2. If you checked "Yes" in the last column of Table 1, indicating that improvements are required, address the following:
 - (a) Briefly describe the improvements proposed for the public roadway(s) associated with the site entrance(s):
 - (b) A copy of the proposed improvement design submitted to the agency exercising maintenance responsibility over the roadway is attached herein: Yes No. If you checked "No" please explain:
 - (c) A copy of the response letter from the agency exercising maintenance responsibility over the roadway(s) associated with the site entrance(s) approving the improvement design is attached herein: Yes No. If you checked "No" please explain:

V. Facility Location and Operation Information Used in Estimating Transportation Data
--

1. Facility Location Information

City of Del Rio Landfill
1897987 Railway Ave
Del Rio, Val Verde County, Texas 78840

2. Waste Acceptance Rates

- (a) Initial Waste Acceptance Rate: **47,068 tons/year**
- (b) Estimated Maximum Waste Acceptance Rate at any Time During Facility Life: **76,752 tons/year**

3. Hours of Operation and Site Life

- (a) Operating Hours: **Monday - Friday 7:00 AM to 5:00 PM**
Saturday 7:00 AM - 3:00 PM
- (b) Waste Acceptance Hours: **Monday - Friday 7:00 AM to 5:00 PM**
Saturday 8:00 AM - 2:00 PM
- (c) Estimated Site Life: **44 years**

4. Other Information Used or Assumed in Estimating Transportation Data: **NA**

Transportation Data and Coordination Report for MSW Type I Landfills

Facility Name: City of Del Rio LandfillRevision No.: 1Permit No: MSW-207C

Date: March 7, 2025

VI. Facility Daily Traffic Volume Data

- Complete Table 2 with estimated existing daily volume of traffic generated by the facility.

Table 2: Estimated Existing Daily Volume of Traffic Generated

Vehicle Type	Traffic Volume to Facility (vehicles per day, vpd)	Traffic Volume from Facility (vpd)
Trucks	224	224
Employee Vehicles	15	15
Visitors Vehicles	15 (assumed based on City personnel's comments)	15 (assumed based on City personnel's comments)
Other Vehicles	10 (assumed based on City personnel's comments)	10 (assumed based on City personnel's comments)
Summation of Daily Volume of Traffic to and from the Facility		
Total Daily Volume of Traffic	264	224

- Describe the source(s) of or method(s) used to obtain the existing daily volume of traffic generated by the facility: **Truck traffic count based on scale house**
- Location(s) of traffic counts (if applicable): **Facility entrance**

- Complete Table 3 with estimated future daily volume of traffic generated by the facility.

Table 3: Estimated Future Daily Volume of Traffic Generated

Vehicle Type	Traffic Volume to Facility (vpd)	Traffic Volume from Facility (vpd)
Trucks	362	362
Employee Vehicles	25	25
Visitors Vehicles	15 (assumed based on City personnel's comments)	15 (assumed based on City personnel's comments)
Other Vehicles	10 (assumed based on City personnel's comments)	10 (assumed based on City personnel's comments)
Summation of Daily Volume of Traffic to and from the Facility		
Total Daily Volume of Traffic	412	412

- Describe the method(s) used to obtain the estimated future daily volume of traffic generated by the facility, including dates, traffic growth rates, and sources of the

Transportation Data and Coordination Report for MSW Type I Landfills

Facility Name: City of Del Rio Landfill

Revision No.: 1

Permit No: MSW-207C

Date: March 7, 2025

growth rates: The projected traffic volumes were obtained using projected growth rates for the surrounding population area growth rate

4. Maps showing the facility boundary and roads within 1 mile of the facility that provide access to the site are attached herein. Yes No . If you checked "No" please explain:

VII. Availability and Adequacy of Roads

1. Complete Table 4 with information regarding the primary access roadways.

Table 4: Roadway Characteristics of the Primary Access Roadways

List the roads that the owner or operator will use as primary access to the site	Existing Annual Average Daily Traffic on Roadway (vpd)	Expected Annual Average Daily Traffic on Roadway (vpd)	Existing Roadway Capacity	Expected Roadway Capacity	Max Gross Weight Allowed (lbs)	Max/Min Posted Speed Limit (mph)	Min Vertical Clearance (ft)	Surface Type and No. of Lanes	Level of Service	Existing Traffic Generated by the Facility on Each Roadway	Expected Traffic Generated by the Facility on Each Roadway
Railway Ave	2,371	3,835				35	13' 10"	2-lane Asphalt		224	362
US 90	18,394	29,751				60		4-lane asphalt		224	362

2. Complete Table 5 with information regarding other access roadways within one mile.

Table 5: Roadway Characteristics of Other Access Roadways within One Mile of the Facility Boundary

List other access roadways within 1 mile of the facility	Existing Annual Average Daily Traffic on Roadway	Expected Annual Average Daily Traffic on Roadway	Existing Roadway Capacity	Expected Roadway Capacity	Max Gross Weight Allowed (lbs)	Max/Min Posted Speed Limit (mph)	Min Vertical Clearance (ft)	Surface Type and No. of Lanes	Level of Service	Existing Traffic Generated by the Facility on Each Roadway	Expected Traffic Generated by the Facility on Each Roadway
US 277	18,473	29,879				30		4-lane asphalt		224	362

Transportation Data and Coordination Report for MSW Type I Landfills

Facility Name: City of Del Rio LandfillRevision No.: 1Permit No: MSW-207C

Date: March 7, 2025

- Complete Table 6 with information regarding access roadway intersections within one mile.

Table 6: Roadway Intersection Characteristics

Please list major (signalized) roadway intersections for access roads within 1 mile of facility	Existing Capacity	Existing Level of Service
Railway Ave and US 90	NA	NA

- (For applicants that conducted traffic counts) Peak period traffic counts were conducted at critical intersections and roadways in the area: Yes No

If "No" is checked, please explain: **The traffic count coming into the facility is minimal when compared to the overall traffic on the road.**

VIII. Conclusions on the availability and adequacy of roads to be used for accessing the facility

Enter conclusions regarding the availability and adequacy of roads to be used for accessing the facility using information obtained from access roadway data; data on the volume of existing and expected vehicular traffic on the access roads within one mile of the facility; and the projection of the volume of traffic expected to be generated by the facility on the access roads:

Based on the traffic count provided by TxDOT for US 90 and US 277, the traffic volume created by the facility is minimal and will not adversely impact the availability and adequacy of the roads to be used for accessing the facility.

IX. Highway Beautification

Enter facility distance from interstate or primary highways and screening information as required by 30 TAC 330.23(a).

- Distance of Facility from Interstate or Primary Highway: 0.5 miles
- Type of Facility Screening Provided, if applicable: **Facility located far enough from US 90 and cannot be seen from the highway.**

Transportation Data and Coordination Report for MSW Type I Landfills

Facility Name: City of Del Rio LandfillRevision No.: 1Permit No: MSW-207C

Date: March 7, 2025

X. Analysis of the Impact of the Facility upon Airports

Enter the Part, Appendix, Attachment, Section, and Page Number of the application where analysis of the impact of the facility upon airports is provided: **Parts I/II Section 8, page I/II-9**

XI. Documentation of Coordination with the Federal Aviation Administration for Compliance with Airport Location Restrictions

1. Applicant has submitted written information to FAA describing the facility location, maximum height of waste units, type of waste accepted at the facility, and other facility-relevant data and information as required: Yes No

(a) Enter Date of Coordination Letter to FAA: **July 5, 2024**

(b) Enter Date of FAA Response: **September 12, 2024** ~~till waiting for a response~~

2. Indicate FAA Response and Final Action:

FAA Acknowledged No Adverse Impact.

FAA Recommended Safety Improvements. *(Complete Section XII if you check this item.)*

3. A copy of the Documentation of Coordination with FAA for compliance with airport location restrictions is attached herein. Yes No. If you checked "No" please explain:

Coordination with FAA is documented in Appendix I/IIB.

XII. FAA Recommended Changes or Improvements for Airport Safety, (as applicable)

Enter FAA's recommended changes or improvements to the facility for airport safety or for compliance with airport location restrictions.

No recommended changes or improvements to the facility for airport safety or compliance with the airport location restrictions were received from the FAA. Still waiting for a response from FAA

Transportation Data and Coordination Report for MSW Type I Landfills

Facility Name: City of Del Rio LandfillRevision No.: 1Permit No: MSW-207C

Date: March 7, 2025

XIII. Attachments

- Maps showing the facility boundary and roads within 1 mile of the facility.
- Documentation of coordination of all designs of proposed public roadway improvements associated with site entrances with the agency exercising maintenance responsibility of the public roadway involved; and the response letter received from the agency, as applicable.
- Documentation of coordination with the Texas Department of Transportation (TxDOT) for traffic and location restrictions, including any traffic study report; and the response letter received from TxDOT.
- Documentation of coordination with the Federal Aviation Administration for compliance with airport location restrictions; and the response letter received from FAA.
- Other documents attached:

CITY OF DEL RIO LANDFILL

VAL VERDE COUNTY, TEXAS
TCEQ PERMIT NO. MSW-207C

MAJOR PERMIT AMENDMENT APPLICATION PART III – SITE DEVELOPMENT PLAN

SITE DEVELOPMENT PLAN

Prepared for
City of Del Rio

September 2023
Revision 1 August 2024
Revision 2 March 2025



Prepared by
CP&Y an STV Company
TPBE Registration No. F-1741
13155 Noel Road, Suite 200
Dallas, TX 75240
214-638-0500

This document is intended for permitting purposes only.

TABLE OF CONTENTS

LIST OF ACRONYMS	III-iii
1.0 INTRODUCTION (§330.63(a))	III-1
2.0 GENERAL FACILITY DESIGN (§330.63(b))	III-1
2.1 Facility Access (§330.63(b)(1))	III-1
2.1.1 Site Access	III-1
2.1.2 Access Control	III-1
2.2 Waste Movement (§330.63(b)(2))	III-1
2.2.1 Waste Movement Flow Diagram (§330.63(b)(2)(A))	III-1
2.2.2 Waste Disposal Schematic View (§330.63(b)(2)(B)).....	III-3
2.2.3 Ventilation and Odor Control (§330.63(b)(2)(C))	III-3
2.2.4 Generalized Construction Details (§330.63(b)(2)(D))	III-3
2.3 Water Pollution Control (§330.63(b)(4))	III-3
2.4 Protection of Endangered Species (§330.63(b)(5))	III-4
3.0 FACILITY SURFACE WATER DRAINAGE REPORT (§330.63(c))	III-6
3.1 General.....	III-6
3.2 Site Drainage Patterns	III-6
3.3 Perimeter Drainage System	III-7
3.4 Below Grade Stormwater Controls.....	III-7
3.5 Aerial Fill Stormwater Controls.....	III-7
3.6 Erosion and Sedimentation Control.....	III-8
3.7 Floodplain Information (§330.63(c)(2))	III-8
3.8 Wetlands Information.....	III-8
4.0 LANDFILL UNIT DESIGN (§330.63(d)(4))	III-9
4.1 All-Weather Operation (§330.63(d)(4)(A))	III-9
4.2 Landfill Methods (§330.63(d)(4)(B))	III-9
4.3 Liner and Final Cover System Design (§330.63(d)(4)(C))	III-9
4.3.1 Liner System for the Developed and Undeveloped Areas	III-9
4.3.2 Overliner System for the Pre-Subtitle D Area	III-10
4.3.3 Leachate Collection System	III-10
4.3.4 Final Cover System	III-11
4.4 Estimated Rate of Solid Waste Deposition (§330.63(d)(4)(D)).....	III-11
4.5 Typical Unit Cross-Sections (§§330.63(d)(4)(E) and (F))	III-12
4.6 Liner Quality Control Plan (§330.63(d)(4)(G)).....	III-12
5.0 COMPLIANCE WITH §330.63(e) THROUGH §330.63(j)	III-13
APPENDIX IIIA – Landfill Unit Design Information	
APPENDIX IIIB – Site Life Calculations	
APPENDIX IIIC – Leachate and Contaminated Water Management Plan	

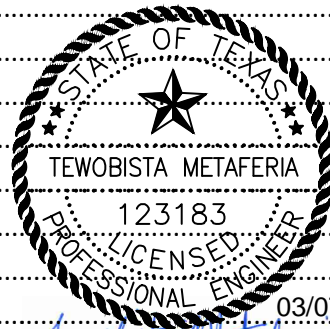

Teobista Metaferia

- APPENDIX IIID – Liner Quality Control Plan
- APPENDIX IIIE – Closure Plan
- APPENDIX IIIF – Post-Closure Care Plan
- APPENDIX IIIG – Closure and Post-Closure Care Cost Estimate
- APPENDIX IIIH – Surface Water Drainage Plan
- APPENDIX III I – Groundwater Sampling and Analysis Plan
- APPENDIX IIIJ – Geology Report
- APPENDIX IIIK – Waste Containment Point of Compliance
- APPENDIX IIIL – Geotechnical Report
- APPENDIX IIIM – Landfill Gas Management Plan
- APPENDIX IIIN – No Migration Determination

LIST OF TABLES

Table 4-1 Liner System Components III-10

Table 4-2 Overliner System Components III-10

Table 4-3 Final Cover System Components III-11

LIST OF FIGURES

Figure III 2.1 – Waste Movement Flow Diagram III-2

Figure III 2.2 – Landfill Schedmatic Plan III-5



4.3.4 Final Cover System

The final cover system will provide a low maintenance cover, protect against erosion, reduce rainfall percolation through the cover system, and subsequently minimize leachate generation within the landfill. As depicted on Appendix IIIA, Figure IIIA-A.2 - Landfill Completion Plan, a maximum of 5 percent topslopes and 4H:1V sideslopes are provided to minimize erosion and facilitate drainage of the landfill. A final cover will be constructed over the existing pre-Subtitle D and Subtitle D waste disposal areas. The final cover system components are described in Table 4-3 with layers listed from top to bottom. The maximum waste and final cover elevations are 1120.5 ft-msl and 1124 ft-msl, respectively.

A demonstration that the specified final cover design will provide effective long-term erosional stability is included in Part III, Appendix IIIH - Surface Water Drainage Plan (Appendix IIIH-D). The final cover system will be constructed as outlined in Appendix E – Closure Plan.

Table 4-3 Final Cover System Components

Top Slopes	Side Slopes
12-inch-thick erosion layer	24-inch-thick erosion layer
18-inch-thick compacted clay infiltration layer with $K = 10^{-7.5}$ cm/s	18-inch-thick compacted clay infiltration layer with $K = 10^{-7.5}$ cm/s

The closed landfill cells (Cells 1 and 2) are built consistent with the final cover system shown in Table 4-3, which was approved as part of MSW Permit 207B.

4.4 Estimated Rate of Solid Waste Deposition (§330.63(d)(4)(D))

The City of Del Rio Landfill primary serves residences and businesses in the City of Del Rio and Val Verde County. The major classifications of solid waste to be accepted by this facility for disposal include both residential and commercial MSW. Such waste consists of household wastes, construction-demolition waste, and various non-hazardous industrial and special wastes as authorized by the TCEQ. Based on the 2022 fiscal year TCEQ Annual Report, the landfill waste inflow is 47,067 tons (152 tons per day based on a 309-day operating schedule).

After 2022, the waste inflow rate is assumed to increase consistent with the projected growth rate for the facility's general service area. The projected growth rate is based on the TWDB population growth projections for the area and may vary. Based on the projected yearly waste inflow over the site life of the facility, this service area will generate an average of approximately 60,486 tons per year (196 tons per day based on a 309-day operating schedule).

CITY OF DEL RIO LANDFILL

VAL VERDE COUNTY, TEXAS
TCEQ PERMIT NO. MSW-207C

MAJOR PERMIT AMENDMENT APPLICATION PART III – SITE DEVELOPMENT PLAN

APPENDIX IIIA LANDFILL UNIT DESIGN INFORMATION

Prepared for
City of Del Rio

September 2023
Revision 1 August 2024
[Revision 2 March 2025](#)



Prepared by
CP&Y an STV Company
TPBE Registration No. F-1741
13155 Noel Road, Suite 200
Dallas, TX 75240
214-638-0500

This document is intended for permitting purposes only.

TABLE OF CONTENTS

1.0 INTRODUCTION IIIA-1
2.0 PERMITTED LINER SYSTEM FOR THE SUBTITLED D AREA IIIA-1
3.0 PERMITTED OVERLINER SYSTEM IIIA-2
4.0 FINAL COVER SYSTEM IIIA-3

Appendix IIIA-A Liner, Overliner, and Final Cover System Details
Appendix IIIA-B Landfill Unit Cross Sections

LIST OF TABLES

Table 2-1 Liner System Components IIIA-1
Table 2-2 Leachate Collection Layer Analysis Summary for the Developed Subtitle D Areas IIIA-1
Table 3-1 Overliner System Components IIIA-2
Table 4-1 Final Cover System Components IIIA-3



4.0 FINAL COVER SYSTEM

Once the site reaches the permitted waste fill grades, a final cover system will be installed to limit the infiltration of stormwater into the landfill. The completion plan for the City of Del Rio Landfill is shown on Figure IIIA-A.2. The final cover system for the City of Del Rio Landfill is shown in Table IIIA 4-1. Details of the final cover system design is discussed in section below and shown on Figures IIIA-A.6 and IIIA-A.7.

Material specifications along with construction and testing procedures for the final cover system are provided in Appendix IIID.

Table 4-1 Final Cover System Components

Subtitle D Composite Final Cover System	
Top Slopes	Side Slopes
12-inch-thick erosion layer	24-inch-thick erosion layer
18-inch-thick compacted clay infiltration layer with $k \leq 10^{-7.5}$ cm/s	18-inch-thick compacted clay infiltration layer with $k \leq 10^{-7.5}$ cm/s

As part of the final cover construction, an erosion layer capable of sustaining native vegetation will be constructed. Areas that receive final cover will be seeded upon completion of final cover placement. A soil loss and sheet flow velocity demonstration for the erosion layer is included in Appendix IIIH. The erosion layer will include a vegetation layer that provides for a 90 percent ground coverage. If there are areas that do not maintain at least 90 percent coverage they will be re-seeded until at least 90 percent coverage is maintained.

In addition, permanent final cover erosion control structures (swales and chutes) will be constructed upon installation of the final cover. The stormwater controls for the landfill have been designed consistent with the TCEQ regulations for Type I MSW landfills. The stormwater runoff/runoff controls have been designed for a 25-year frequency storm event. These include drainage controls for the final cover, perimeter drainage channels, culverts, and detention ponds, including pond outfalls. The design details of the final cover system erosion control structures is provided in Appendix IIIH - Surface Water Drainage Report.

Final cover has been constructed over Cells 1, 2 and a portion of the pre-Subtitle D as shown in Figure IIIA-A.2. The TCEQ acceptance letter for the closure is included in Appendix IIID-A. The constructed final cover over the portion of the pre-Subtitle D and subtitled D areas will remain in place.

A stability analysis for the proposed excavation and proposed final cover systems is provided in Appendix IIIL - Geotechnical Report.

CITY OF DEL RIO LANDFILL

VAL VERDE COUNTY, TEXAS

TCEQ PERMIT NO. MSW-207C

MAJOR PERMIT AMENDMENT APPLICATION PART III – SITE DEVELOPMENT

APPENDIX IIIA-A

LINER, OVERLINER AND FINAL COVER SYSTEM DETAILS

Prepared for
City of Del Rio

September 2023
Revision 1 August 2024
[Revision 2 March 2025](#)

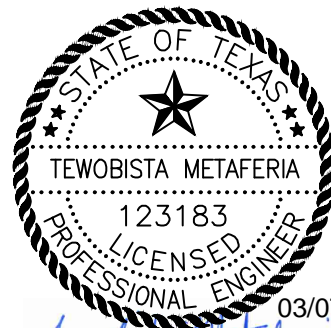

03/07/2025

Te wobista Metaferia

Prepared by
CP&Y an STV Company
TPBE Registration No. F-1741
13155 Noel Road, Suite 200
Dallas, TX 75240
214-638-0500

This document is intended for permitting purposes only.

TABLE OF CONTENTS

- Figure IIIA-A.1 – Excavation and Overliner Plan
- Figure IIIA-A.2 – Completion Plan
- Figure IIIA-A.3 - Liner System Details I (Currently Approved Plan)
- Figure IIIA-A.4 - Liner System Details II (Currently Approved Plan)
- Figure IIIA-A.5 - Leachate Collection System Details
- Figure IIIA-A.6 - Final Cover Details I (Currently Approved Plan)
- Figure IIIA-A.7 - Final Cover Details II (Currently Approved Plan)
- Figure IIIA-A.8 – Overliner Details (Currently Approved Plan)



LEGEND

- PERMIT BOUNDARY
- CLOSED CELL BOUNDARY
- LIMIT OF WASTE
- 1090 VAL COVER CONTOURS
- 1084 - EXISTING CONTOURS
- PERIMETER CHANNEL
- SWALES
- EXISTING SITE FENCE
- PROPOSED SITE FENCE
- EXISTING CHUTE
- CHUTES
- GP-5 PROPOSED GAS PROBE
- UV-1 PROPOSED GAS VENTS

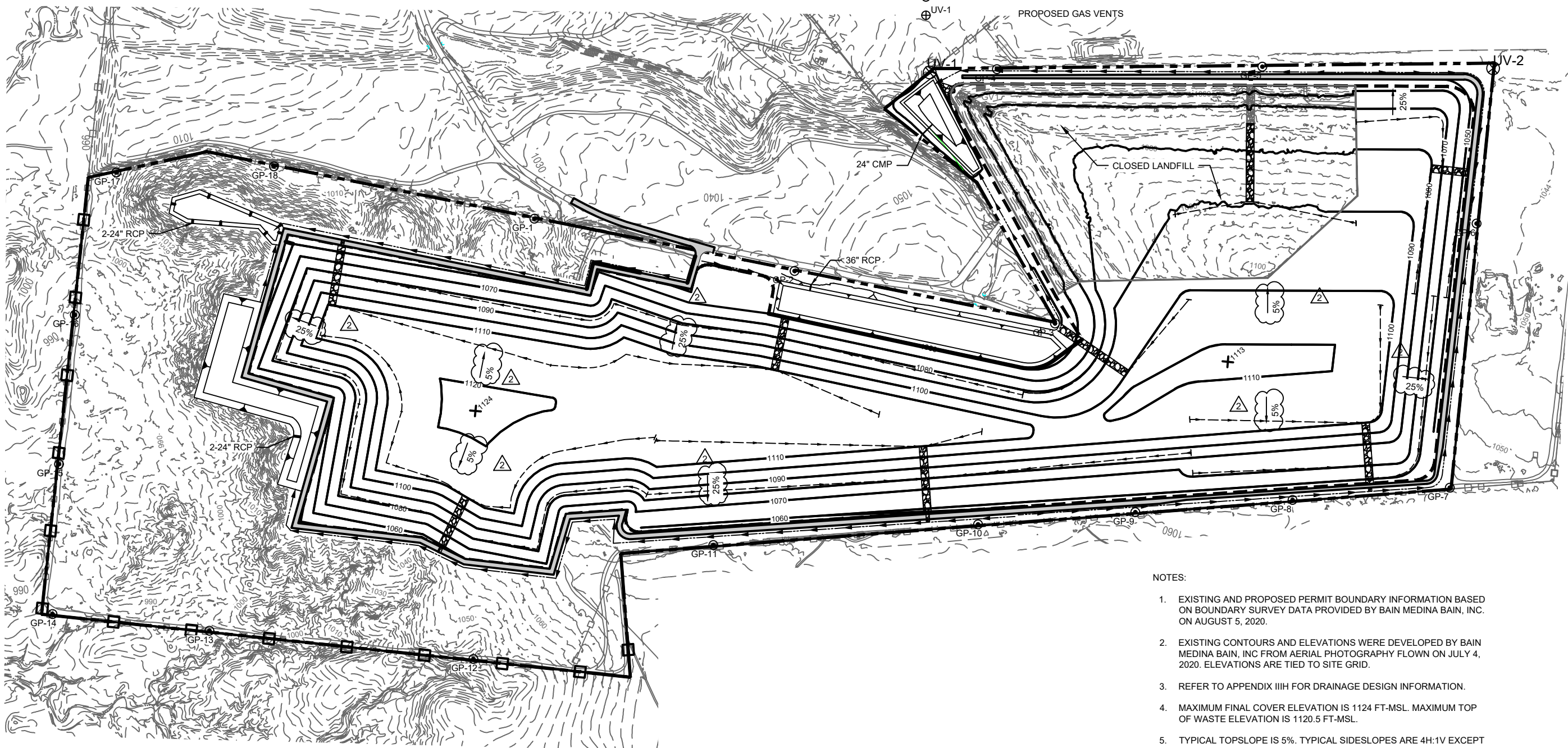
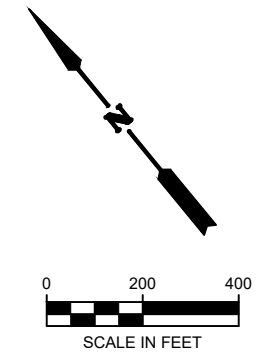

NOTES:

1. EXISTING AND PROPOSED PERMIT BOUNDARY INFORMATION BASED ON BOUNDARY SURVEY DATA PROVIDED BY BAIN MEDINA BAIN, INC. ON AUGUST 5, 2020.
2. EXISTING CONTOURS AND ELEVATIONS WERE DEVELOPED BY BAIN MEDINA BAIN, INC FROM AERIAL PHOTOGRAPHY FLOWN ON JULY 4, 2020. ELEVATIONS ARE TIED TO SITE GRID.
3. REFER TO APPENDIX IIIH FOR DRAINAGE DESIGN INFORMATION.
4. MAXIMUM FINAL COVER ELEVATION IS 1124 FT-MSL. MAXIMUM TOP OF WASTE ELEVATION IS 1120.5 FT-MSL.
5. TYPICAL TOPSLOPE IS 5%. TYPICAL SIDESLOPES ARE 4H:1V EXCEPT IN THE AREA OF THE CLOSED PORTION OF THE LANDFILL IN WHICH THE SIDESLOPES ARE 5H:1V.

PRINTED BY: Metaferia DATE: 8/22/2024
 FILE PATH: C:\pwworking\stvw_s\time\delr200302\Figure IIIA-A.2.dwg

an STV Company

TEXAS REGISTERED ENGINEERING FIRM
TBPE F-1741

CITY OF DEL RIO
TEXAS

STATE OF TEXAS
PROFESSIONAL ENGINEER
123183
10/07/2025

NO.	REVISION	BY	DATE
2	2ND TECHNICAL NOB	STV	03/2025
1	1ST TECHNICAL NOB	STV	08/2024

VERIFY SCALE BAR LENGTH EQUALS ONE INCH ON ORIGINAL DRAWING. VERIFY LENGTH ON THIS SHEET AND ADJUST SCALE ACCORDINGLY.

CITY OF DEL RIO LANDFILL NO. 207C
MAJOR PERMIT AMENDMENT

LANDFILL COMPLETION PLAN

DESIGN: T. METAFERIA	CLIENT: CITY OF DEL RIO
DRAWN: T. METAFERIA	
REVIEW: B. HINDMAN	
CP&Y: DELR200302	

FIGURE
IIIA-A.2

FOR PERMITTING PURPOSES ONLY

NO.	REVISION	BY	DATE
2.	2nd TECHNICAL NOD	STV	03/2025
1.	1ST TECHNICAL NOD	STV	08/2024

VERIFY SCALE: BAR LENGTH EQUALS ONE INCH ON ORIGINAL DRAWING. VERIFY LENGTH ON THIS SHEET AND ADJUST SCALE ACCORDINGLY.

0 1" AND ADJUST SCALE ACCORDINGLY.

CITY OF DEL RIO LANDFILL NO. 207C
MAJOR PERMIT AMENDMENT

FINAL COVER DETAILS I

DESIGN: T. METAFERIA
DRAWN: T. METAFERIA
REVIEW: B. HINDMAN
CP&Y: DELR200302
CLIENT: CITY OF DEL RIO

FIGURE
IIIA-A.6

FOR PERMITTING PURPOSES ONLY

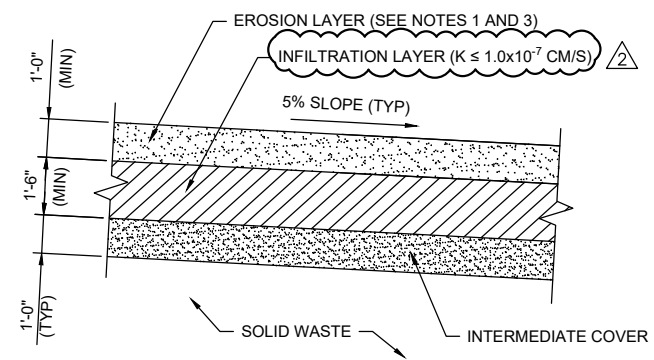

A FINAL COVER-TOPSLOPE
NTS

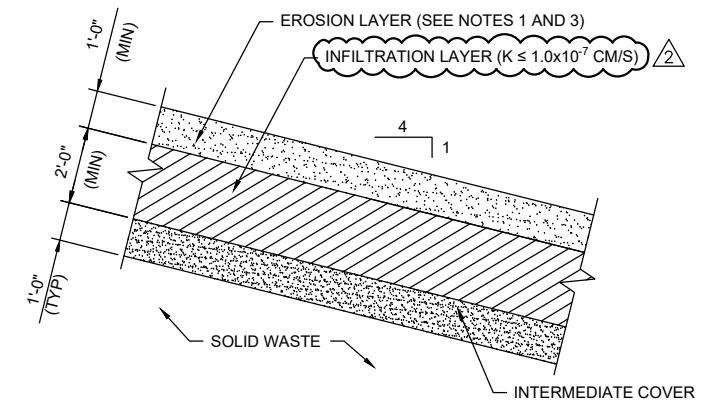

B FINAL COVER-SIDESLOPE
NTS

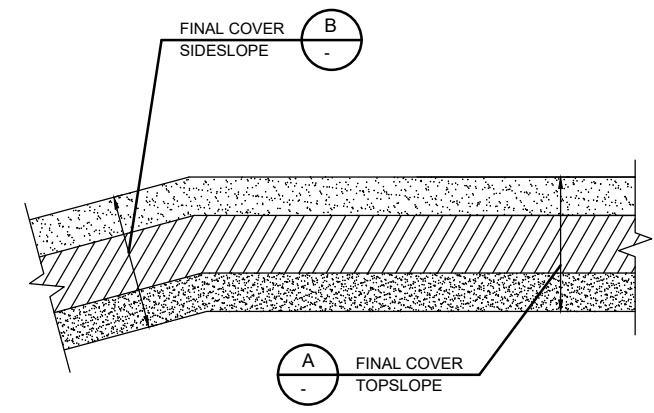

C FINAL COVER- TOP/SIDESLOPE TRANSITION
NTS

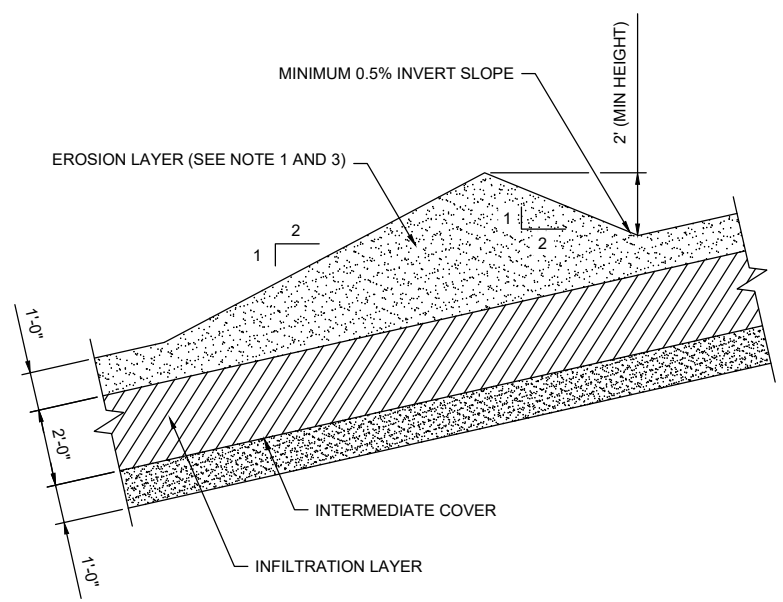

D SIDESLOPE SWALE (TYP)
NTS

NOTES:

1. FINAL COVER OF EROSION LAYER WILL BE CAPABLE OF SUSTAINING SELECTED VEGETATION.
2. FINAL COVER COMPONENTS WILL BE CONSTRUCTED ACCORDING TO FCSQCP (APPENDIX IIIJ-A).
3. EROSION LAYER MAY CONSIST OF BOTH ONSITE AND OFF-SITE SOILS. BORROW SOURCE TO BE SELECTED BY OWNER PRIOR TO CONSTRUCTION.

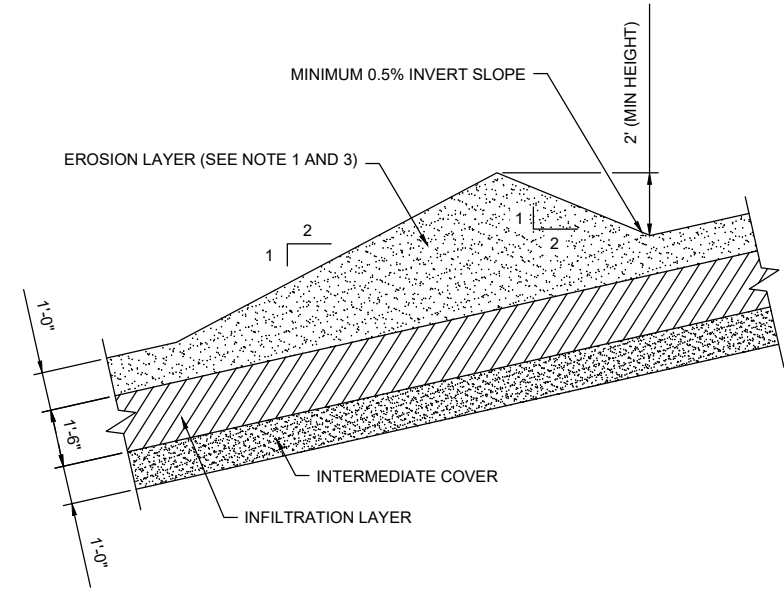

E TOP SLOPE SWALE (TYP)
NTS

PRINTED BY: Metaferia T DATE: 11/14/2024
FILE PATH: C:\pwworking\stvw\metafertad\0942271\DELIR200302\Figure IIIA-A.6.dwg

CITY OF DEL RIO LANDFILL
VAL VERDE COUNTY, TEXAS
TCEQ PERMIT NO. MSW-207C

MAJOR PERMIT AMENDMENT APPLICATION
PART III – SITE DEVELOPMENT

APPENDIX IIIA-B
LANDFILL UNIT CROSS SECTIONS

Prepared for
City of Del Rio

September 2023
Revision 1 August 2024
[Revision 2 March 2025](#)



Teowobista Metaferia

Prepared by
CP&Y, an STV company
TPBE Registration No. F-1741
13155 Noel Road, Suite 200
Dallas, TX 75240
214-638-0500

This document is intended for permitting purposes only.

TABLE OF CONTENTS

Figure IIIA-B.1 - Typical Section Site Plan

Figure IIIA-B.2 - Excavation Plan

Figure IIIA-B.3 - Landfill Completion Plan

Figure IIIA-B.4 - Typical Cross Section A

Figure IIIA-B.5 - Typical Cross Section B

Figure IIIA-B.6 - Typical Cross Section C

Figure IIIA-B.7 - Typical Cross Section D

Figure IIIA-B.8 - Typical Cross Section E

Figure IIIA-B.9 - Typical Cross Section F



LEGEND

	PERMIT BOUNDARY
	CLOSED CELL BOUNDARY
	LIMIT OF WASTE
	FINAL COVER GRADES
	EXISTING GRADES
	PERIMETER CHANNEL
	SWALES
	PROPOSED SITE FENCE
	EXISTING CHUTE
	CHUTES
	PROPOSED GAS PROBE
	PROPOSED GAS VENTS

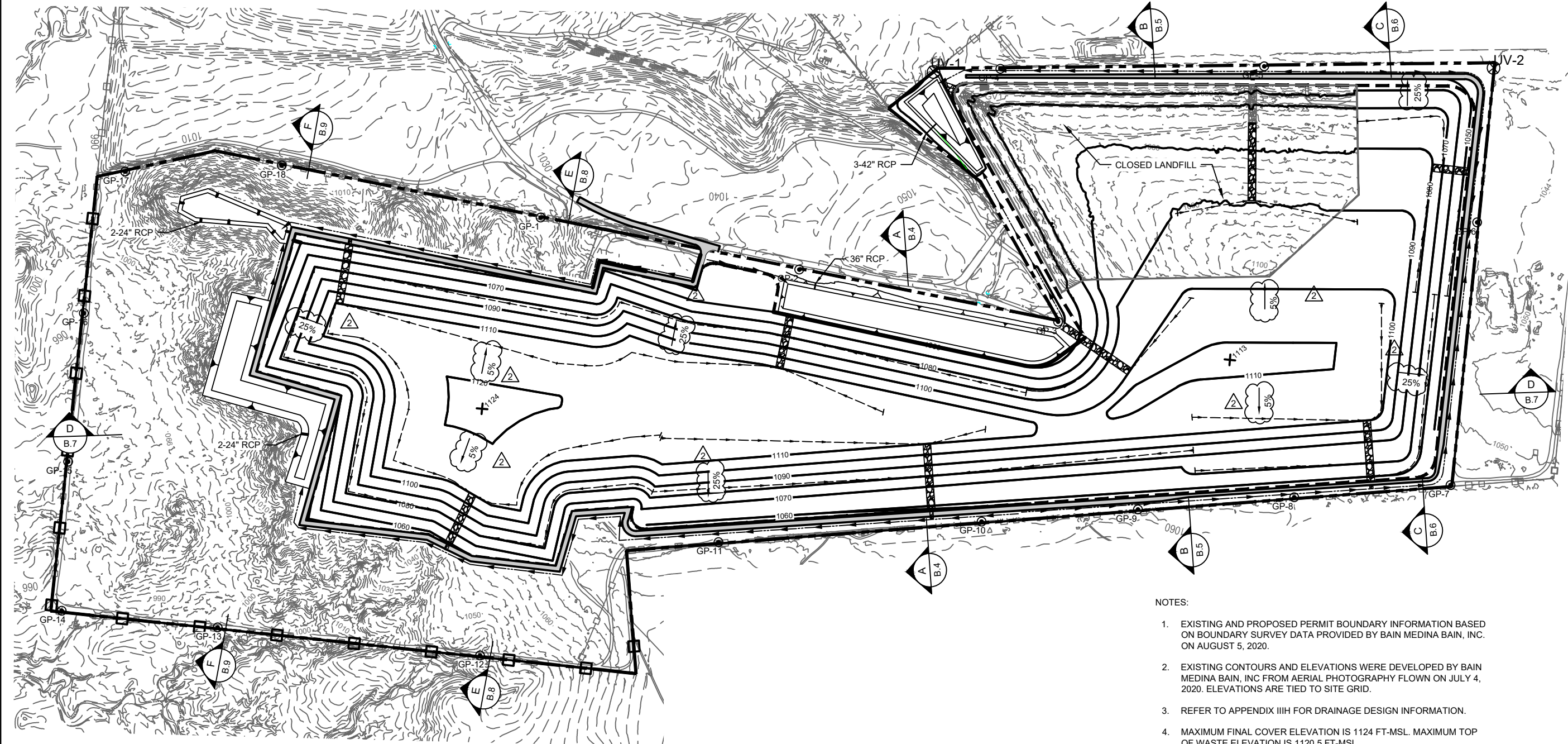
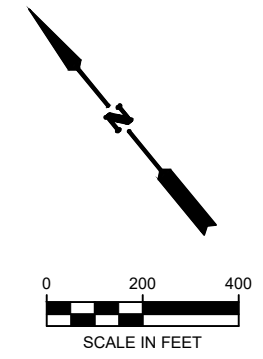

- NOTES:**
1. EXISTING AND PROPOSED PERMIT BOUNDARY INFORMATION BASED ON BOUNDARY SURVEY DATA PROVIDED BY BAIN MEDINA BAIN, INC. ON AUGUST 5, 2020.
 2. EXISTING CONTOURS AND ELEVATIONS WERE DEVELOPED BY BAIN MEDINA BAIN, INC FROM AERIAL PHOTOGRAPHY FLOWN ON JULY 4, 2020. ELEVATIONS ARE TIED TO SITE GRID.
 3. REFER TO APPENDIX IIIH FOR DRAINAGE DESIGN INFORMATION.
 4. MAXIMUM FINAL COVER ELEVATION IS 1124 FT-MSL. MAXIMUM TOP OF WASTE ELEVATION IS 1120.5 FT-MSL.
 5. TYPICAL TOPSLOPE IS 5%. TYPICAL SIDESLOPES ARE 4H:1V EXCEPT IN THE AREA OF THE CLOSED PORTION OF THE LANDFILL IN WHICH THE SIDESLOPES ARE 5H:1V.



NO.	REVISION	BY	DATE
2	2ND TECHNICAL NOB	STV	03/2025
1	1ST TECHNICAL NOB	STV	08/2024

VERIFY SCALE: BAR LENGTH EQUALS ONE INCH ON ORIGINAL DRAWING. VERIFY LENGTH ON THIS SHEET 0' 1" AND ADJUST SCALE ACCORDINGLY.

CITY OF DEL RIO LANDFILL NO. 207C
MAJOR PERMIT AMENDMENT

LANDFILL COMPLETION PLAN

DESIGN: T. METAFERIA
DRAWN: T. METAFERIA
REVIEW: B. HINDMAN
CP&Y: DELR200302
CLIENT: CITY OF DEL RIO

FIGURE
IIIA-B.3

FOR PERMITTING PURPOSES ONLY

PRINTED BY: Metaferia T DATE: 3/20/2025
FILE PATH: C:\pwworking\stvw_s\time\delr\delr200302\Figure IIIA-B.3.dwg

NOTES:

1. TOPOGRAPHIC MAP WAS COMPLETED FROM PHOTOGRAMMETRIC METHODS BY DALLAS AERIAL SURVEY. VERTICAL DATUM BASED ON NGS MEAN SEA LEVEL. MAPPING COMPLETED IN ACCORDANCE WITH NATIONAL MAP ACCURACY STANDARDS.
2. REFER TO APPENDIX IIIA-A FOR LINER, LEACHATE COLLECTION, AND FINAL COVER SYSTEM DETAILS.
3. SEE APPENDIX IIIG FOR BORING DATA. BORINGS PROJECTED INTO THE LINE OF SECTION.
4. AS SHOWN IN APPENDIX I/IIC, THE BUFFER ZONES VARY AROUND THE PERIMETER OF THE SITE, BUT IN NO CASE ARE THEY LESS THAN 50-FEET FOR EXISTING WASTE.
5. REFER TO APPENDIX IIIM, FOR DETAILS OF THE LANDFILL GAS MANAGEMENT PLAN.
6. DRAINAGE DESIGN INFORMATION IS PROVIDED IN APPENDIX IIH-SURFACE WATER DRAINAGE PLAN.
7. MAXIMUM TOP OF FINAL COVER ELEVATION IS 1124 FT-MSL.
8. REFER TO APPENDIX IIIC FOR LEACHATE COLLECTION SYSTEM (LCS) INFORMATION.
9. THE SITE DOES NOT HAVE ANY GROUNDWATER MONITORING WELLS. GROUNDWATER HAS NOT BEEN ENCOUNTERED IN OF THE BORINGS OR DURING CONSTRUCTION OF CELLS 1 THROUGH 6.
10. THIS SITE DOES NOT ACCEPT ANY CLASS 1 WASTE.

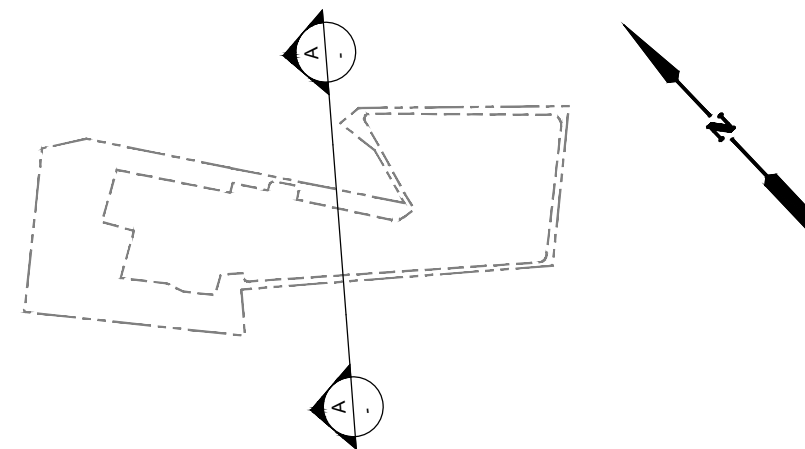

KEY MAP
NTS

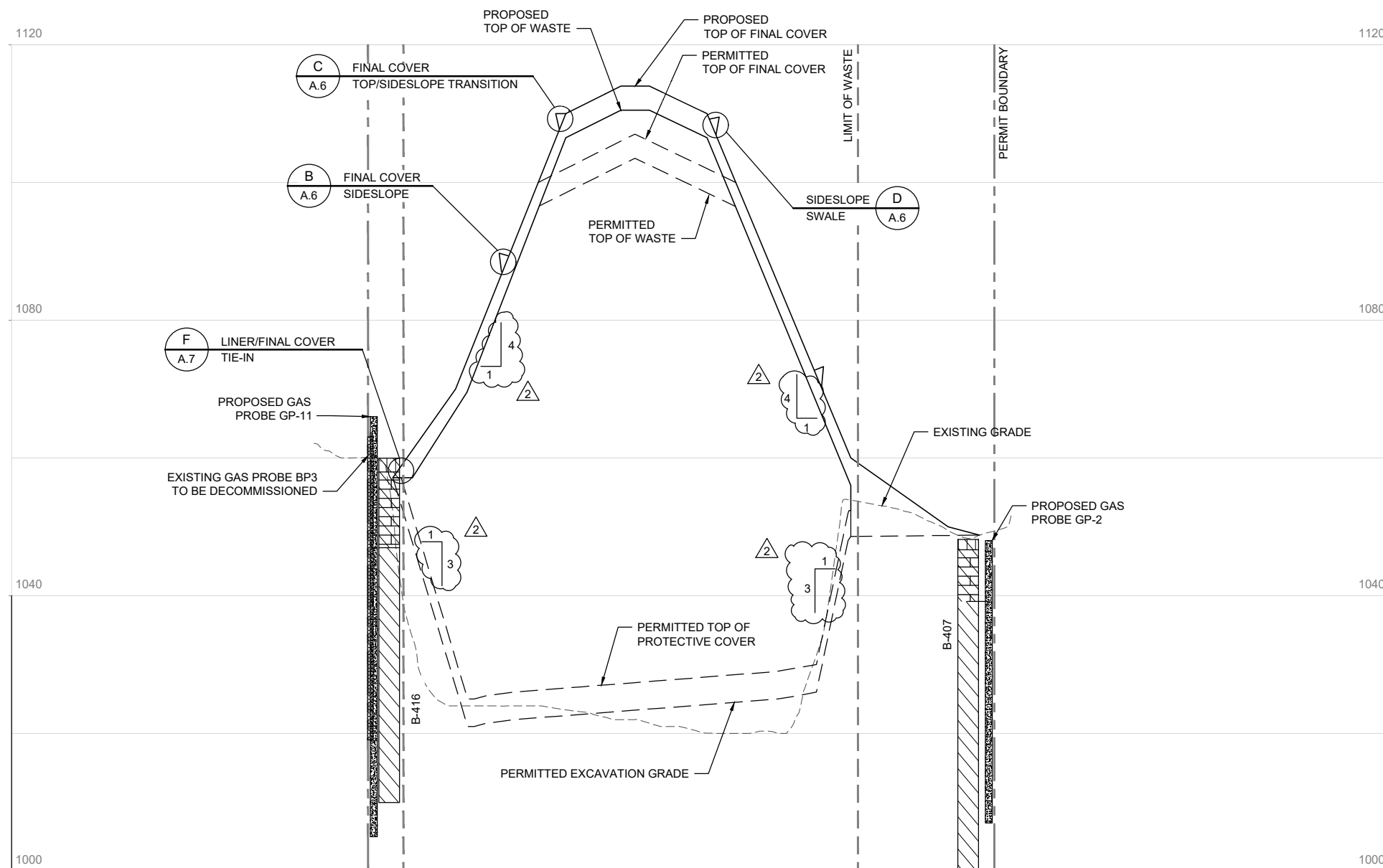

SECTION
A
B.2
HORIZ 0 100 200
VERT 0 10 20
SCALE IN FEET

LEGEND

---	PERMIT BOUNDARY
- - -	LIMIT OF WASTE
[Diagonal Hatching]	CLAY
[Cross-hatch]	CLAY AND CALICHE
[Horizontal Hatching]	SILTY CLAY



NO.	REVISION	BY	DATE
2.	2ND TECHNICAL NOD	STV	03/2025
1.	1ST TECHNICAL NOD	STV	08/2024

VERIFY SCALE BAR LENGTH EQUALS ONE INCH ON ORIGINAL DRAWING. VERIFY LENGTH ON THIS SHEET AND ADJUST SCALE ACCORDINGLY.

CITY OF DEL RIO LANDFILL NO. 207C
MAJOR PERMIT AMENDMENT

CROSS SECTION A

DESIGN: T. METAFERIA
DRAWN: T. METAFERIA
REVIEW: B. HINDMAN
CP&Y: DELR200302
CLIENT: CITY OF DEL RIO

FIGURE
IIIA-B.4

FOR PERMITTING PURPOSES ONLY

PRINTED BY: Metaferia T
FILE PATH: C:\pwworking\stvt\metaferia\d0942271\DELRL200302\Figure IIIA-B.4.dwg

NOTES:

1. TOPOGRAPHIC MAP WAS COMPLETED FROM PHOTOGRAMMETRIC METHODS BY DALLAS AERIAL SURVEY. VERTICAL DATUM BASED ON NGS MEAN SEA LEVEL. MAPPING COMPLETED IN ACCORDANCE WITH NATIONAL MAP ACCURACY STANDARDS.
2. REFER TO APPENDIX IIIA-A FOR LINER, LEACHATE COLLECTION, AND FINAL COVER SYSTEM DETAILS.
3. SEE APPENDIX IIIG FOR BORING DATA. BORINGS PROJECTED INTO THE LINE OF SECTION.
4. AS SHOWN IN APPENDIX IIIC, THE BUFFER ZONES VARY AROUND THE PERIMETER OF THE SITE, BUT IN NO CASE ARE THEY LESS THAN 50-FEET FOR EXISTING WASTE.
5. REFER TO APPENDIX IIIM, FOR DETAILS OF THE LANDFILL GAS MANAGEMENT PLAN.
6. DRAINAGE DESIGN INFORMATION IS PROVIDED IN APPENDIX IIH-SURFACE WATER DRAINAGE PLAN.
7. MAXIMUM TOP OF FINAL COVER ELEVATION IS 1124 FT-MSL.
8. REFER TO APPENDIX IIIC FOR LEACHATE COLLECTION SYSTEM (LCS) INFORMATION.
9. THE SITE DOES NOT HAVE ANY GROUNDWATER MONITORING WELLS. GROUNDWATER HAS NOT BEEN ENCOUNTERED IN OF THE BORINGS OR DURING CONSTRUCTION OF CELLS 1 THROUGH 6.
10. THIS SITE DOES NOT ACCEPT ANY CLASS 1 WASTE.

LEGEND

- PERMIT BOUNDARY
- - - LIMIT OF WASTE
- ▨ CLAY
- ▩ CLAY AND CALICHE
- ▧ SILTY CLAY

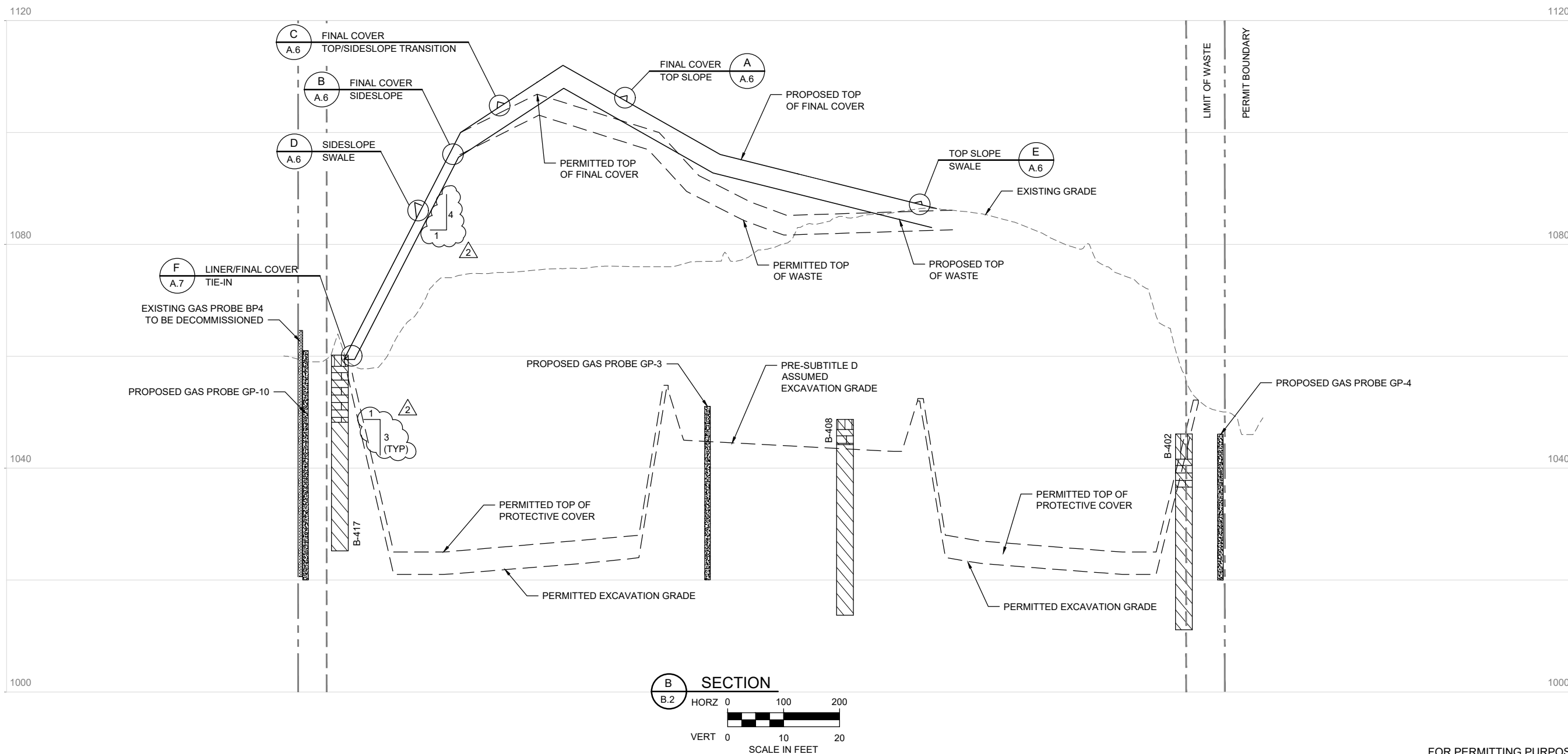
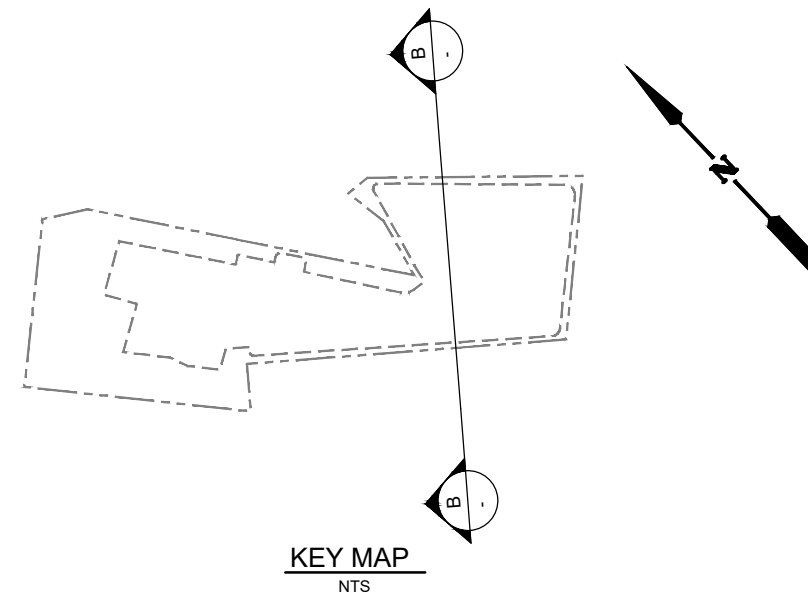

NO.	REVISION	DATE	BY
2.	2ND TECHNICAL NOD	03/2025	STV
1.	1ST TECHNICAL NOD	08/2024	STV

VERIFY SCALE: BAR LENGTH EQUALS ONE INCH ON ORIGINAL DRAWING. VERIFY LENGTH ON THIS SHEET 0 1" AND ADJUST SCALE ACCORDINGLY.

CITY OF DEL RIO LANDFILL NO. 207C
MAJOR PERMIT AMENDMENT

CROSS SECTION B

DESIGN: T. METAFERIA
DRAWN: T. METAFERIA
REVIEW: B. HINDMAN
CP&Y: DELR200302
CLIENT: CITY OF DEL RIO

FIGURE
IIIA-B.5





FOR PERMITTING PURPOSES ONLY

PRINTED BY: Metaferia T
FILE PATH: C:\pwworking\kingstvpw_stv\metaferia\0942271\DELIR200302\Figure IIIA-B.5.dwg

NOTES:

1. TOPOGRAPHIC MAP WAS COMPLETED FROM PHOTOGRAMMETRIC METHODS BY DALLAS AERIAL SURVEY. VERTICAL DATUM BASED ON NGS MEAN SEA LEVEL. MAPPING COMPLETED IN ACCORDANCE WITH NATIONAL MAP ACCURACY STANDARDS.
2. REFER TO APPENDIX IIIA-A FOR LINER, LEACHATE COLLECTION, AND FINAL COVER SYSTEM DETAILS.
3. SEE APPENDIX IIIG FOR BORING DATA. BORINGS PROJECTED INTO THE LINE OF SECTION.
4. AS SHOWN IN APPENDIX I/IC, THE BUFFER ZONES VARY AROUND THE PERIMETER OF THE SITE, BUT IN NO CASE ARE THEY LESS THAN 50-FEET FOR EXISTING WASTE.
5. REFER TO APPENDIX IIIM, FOR DETAILS OF THE LANDFILL GAS MANAGEMENT PLAN.
6. DRAINAGE DESIGN INFORMATION IS PROVIDED IN APPENDIX IIH-SURFACE WATER DRAINAGE PLAN.
7. MAXIMUM TOP OF FINAL COVER ELEVATION IS 1124 FT-MSL.
8. REFER TO APPENDIX IIIC FOR LEACHATE COLLECTION SYSTEM (LCS) INFORMATION.
9. THE SITE DOES NOT HAVE ANY GROUNDWATER MONITORING WELLS. GROUNDWATER HAS NOT BEEN ENCOUNTERED IN OF THE BORINGS OR DURING CONSTRUCTION OF CELLS 1 THROUGH 6.
10. THIS SITE DOES NOT ACCEPT ANY CLASS 1 WASTE.

LEGEND

	PERMIT BOUNDARY
	LIMIT OF WASTE
	CLAY
	CLAY AND CALICHE
	SILTY CLAY

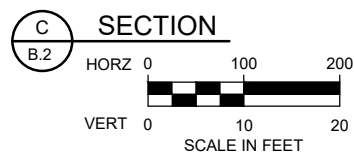
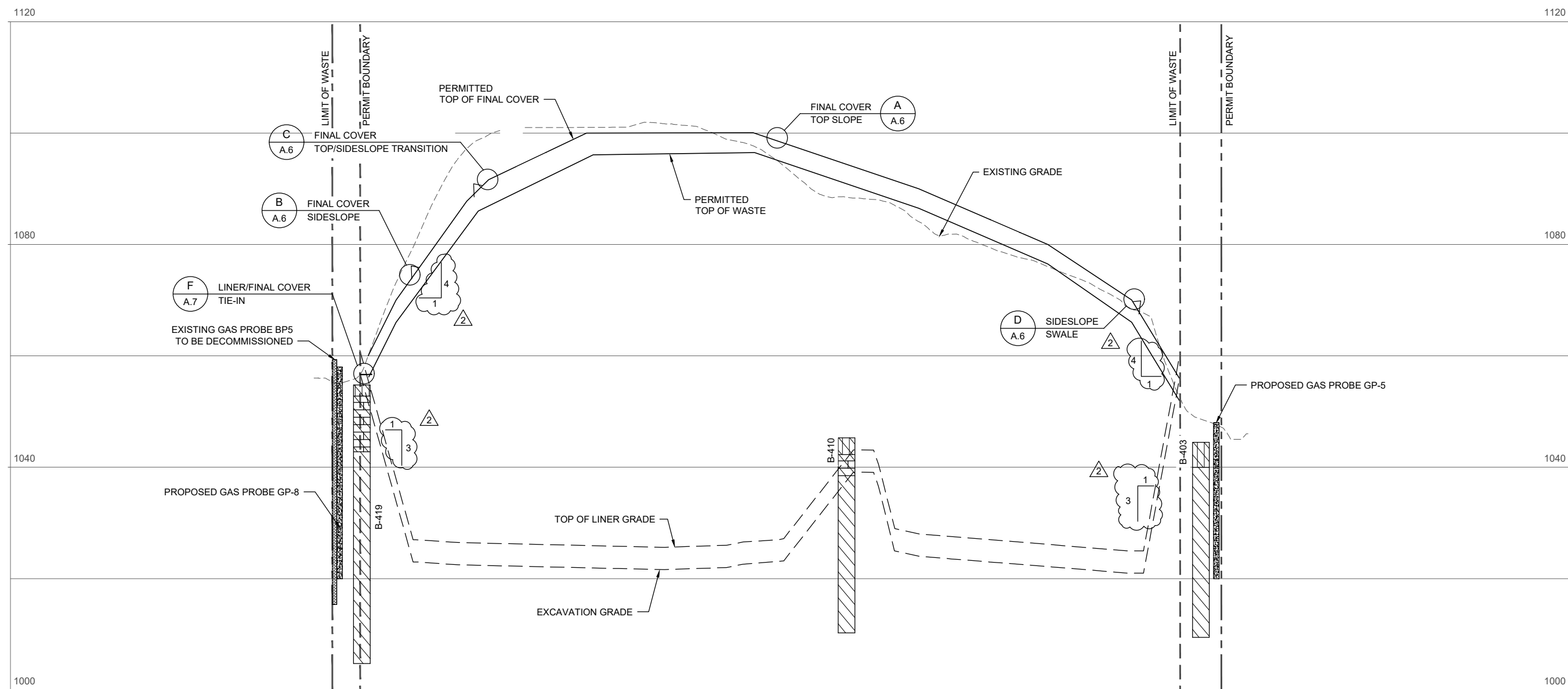
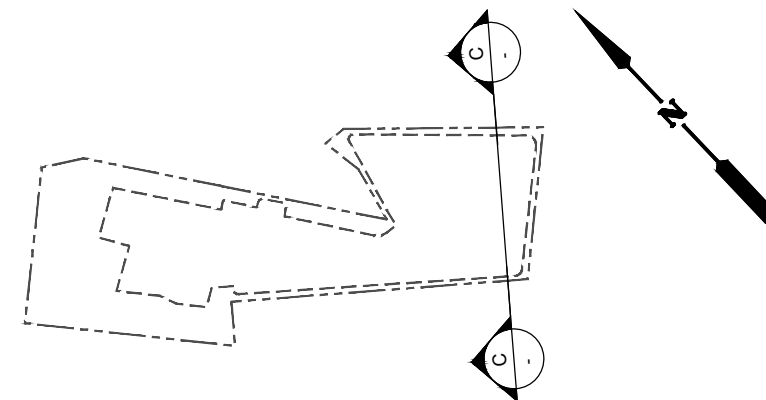

NO.	REVISION	DATE
2.	2ND TECHNICAL NOD	03/2025
1.	1ST TECHNICAL NOD	08/2024

VERIFY SCALE: BAR LENGTH EQUALS ONE INCH ON ORIGINAL DRAWING. VERIFY LENGTH ON THIS SHEET AND ADJUST SCALE ACCORDINGLY.

CITY OF DEL RIO LANDFILL NO. 207C
MAJOR PERMIT AMENDMENT

CROSS SECTION C

DESIGN: T. METAFERIA
DRAWN: T. METAFERIA
REVIEW: B. HINDMAN
CP&Y: DELR200302
CLIENT: CITY OF DEL RIO

FIGURE
IIIA-B.6

NOTES:

1. TOPOGRAPHIC MAP WAS COMPLETED FROM PHOTOGRAMMETRIC METHODS BY DALLAS AERIAL SURVEY. VERTICAL DATUM BASED ON NGS MEAN SEA LEVEL. MAPPING COMPLETED IN ACCORDANCE WITH NATIONAL MAP ACCURACY STANDARDS.
2. REFER TO APPENDIX IIIA-A FOR LINER, LEACHATE COLLECTION, AND FINAL COVER SYSTEM DETAILS.
3. SEE APPENDIX IIII FOR BORING DATA. BORINGS PROJECTED INTO THE LINE OF SECTION.
4. AS SHOWN IN APPENDIX IIIIC, THE BUFFER ZONES VARY AROUND THE PERIMETER OF THE SITE, BUT IN NO CASE ARE THEY LESS THAN 50-FEET FOR EXISTING WASTE.
5. REFER TO APPENDIX IIIM, FOR DETAILS OF THE LANDFILL GAS MANAGEMENT PLAN.
6. DRAINAGE DESIGN INFORMATION IS PROVIDED IN APPENDIX IIIH-SURFACE WATER DRAINAGE PLAN.
7. MAXIMUM TOP OF FINAL COVER ELEVATION IS 1124 FT-MSL.
8. REFER TO APPENDIX IIIC FOR LEACHATE COLLECTION SYSTEM (LCS) INFORMATION.
9. THE SITE DOES NOT HAVE ANY GROUNDWATER MONITORING WELLS. GROUNDWATER HAS NOT BEEN ENCOUNTERED IN OF THE BORINGS OR DURING CONSTRUCTION OF CELLS 1 THROUGH 6.
10. THIS SITE DOES NOT ACCEPT ANY CLASS 1 WASTE.

LEGEND

---	PERMIT BOUNDARY
- - -	LIMIT OF WASTE
[Hatched Box]	CLAY
[Cross-hatched Box]	CLAY AND CALICHE
[Diagonal Hatched Box]	SILTY CLAY
[Dotted Box]	CLAYEY GRAVEL
[Wavy Hatched Box]	CLAY
[Diagonal Hatched Box]	FAT CLAY
[Horizontal Hatched Box]	WEATHERED CLAY-SHALE
[Vertical Hatched Box]	CLAY-SHALE

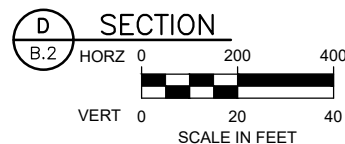
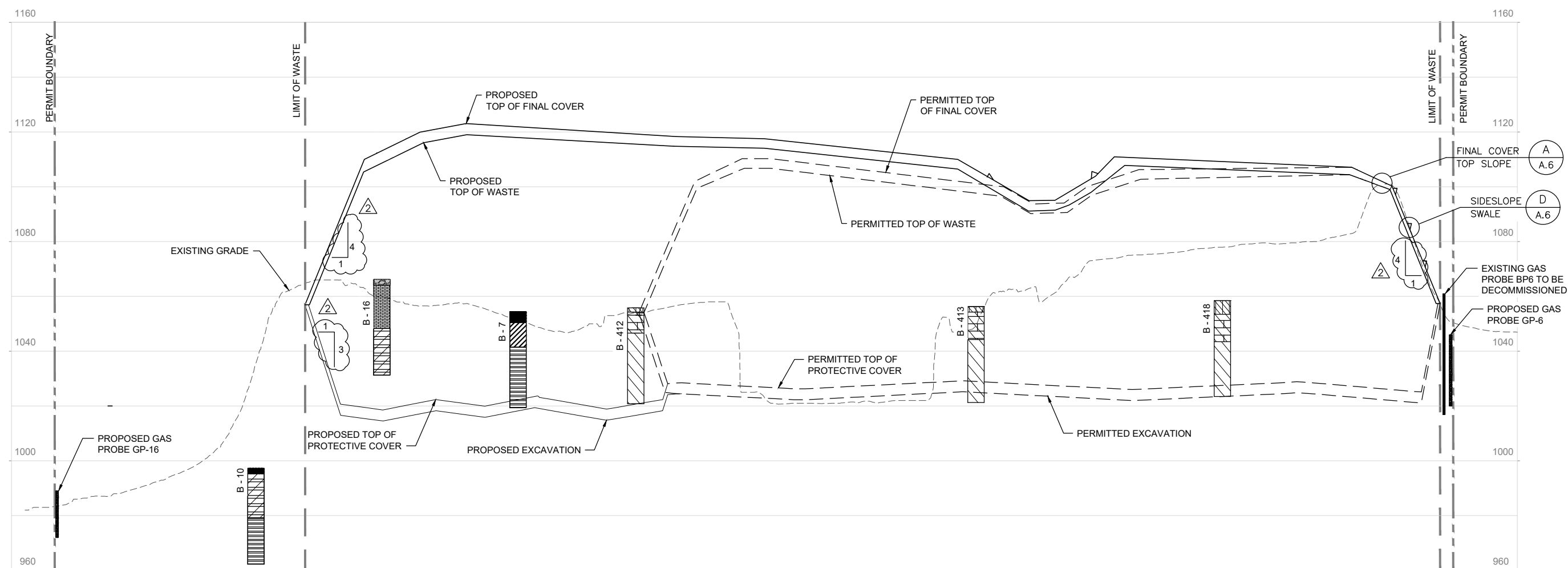
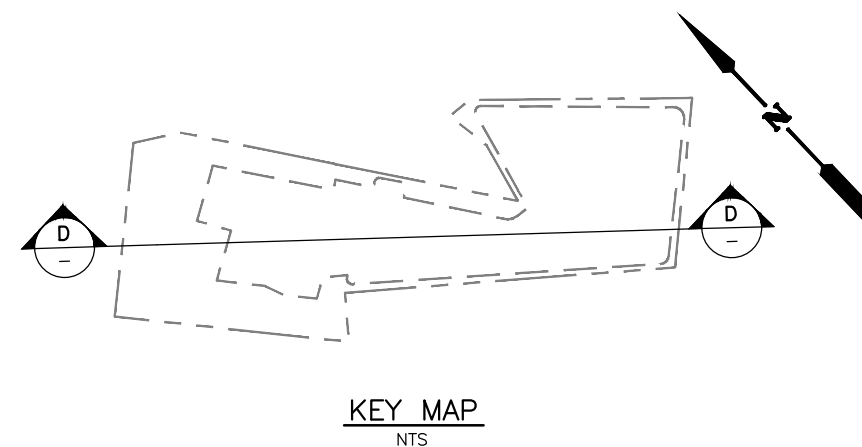

NO.	REVISION	BY	DATE
2.	2ND TECHNICAL NOD	STV	03/2025
1.	1ST TECHNICAL NOD	STV	08/2024

VERIFY SCALE BAR LENGTH EQUALS ONE INCH ON ORIGINAL DRAWING. VERIFY LENGTH ON THIS SHEET AND ADJUST SCALE ACCORDINGLY.

CITY OF DEL RIO LANDFILL NO. 207C
MAJOR PERMIT AMENDMENT

CROSS SECTION D

DESIGN: T. METAFERIA
DRAWN: T. METAFERIA
REVIEW: B. HINDMAN
CP&Y: DELR200302
CLIENT: CITY OF DEL RIO

FIGURE
IIIA-B.7

FOR PERMITTING PURPOSES ONLY

PRINTED BY: Metaferia
FILE PATH: C:\pwworking\stvw\sw\metaf\delr\0942271\DELRLR200302\Figure IIIA-B.7.dwg

NOTES:

1. TOPOGRAPHIC MAP WAS COMPLETED FROM PHOTOGRAMMETRIC METHODS BY DALLAS AERIAL SURVEY. VERTICAL DATUM BASED ON NGS MEAN SEA LEVEL. MAPPING COMPLETED IN ACCORDANCE WITH NATIONAL MAP ACCURACY STANDARDS.
2. REFER TO APPENDIX IIIA-A FOR LINER, LEACHATE COLLECTION, AND FINAL COVER SYSTEM DETAILS.
3. SEE APPENDIX IIIG FOR BORING DATA. BORINGS PROJECTED INTO THE LINE OF SECTION.
4. AS SHOWN IN APPENDIX IIIC, THE BUFFER ZONES VARY AROUND THE PERIMETER OF THE SITE, BUT IN NO CASE ARE THEY LESS THAN 50-FEET FOR EXISTING WASTE.
5. REFER TO APPENDIX IIIM, FOR DETAILS OF THE LANDFILL GAS MANAGEMENT PLAN.
6. DRAINAGE DESIGN INFORMATION IS PROVIDED IN APPENDIX IIH-SURFACE WATER DRAINAGE PLAN.
7. MAXIMUM TOP OF FINAL COVER ELEVATION IS 1124 FT-MSL.
8. REFER TO APPENDIX IIIC FOR LEACHATE COLLECTION SYSTEM (LCS) INFORMATION.
9. THE SITE DOES NOT HAVE ANY GROUNDWATER MONITORING WELLS. GROUNDWATER HAS NOT BEEN ENCOUNTERED IN OF THE BORINGS OR DURING CONSTRUCTION OF CELLS 1 THROUGH 6.
10. THIS SITE DOES NOT ACCEPT ANY CLASS 1 WASTE.

LEGEND

	PERMIT BOUNDARY
	LIMIT OF WASTE
	CLAYEY GRAVEL
	CLAY
	FAT CLAY
	WEATHERED CLAY-SHALE
	CLAY-SHALE

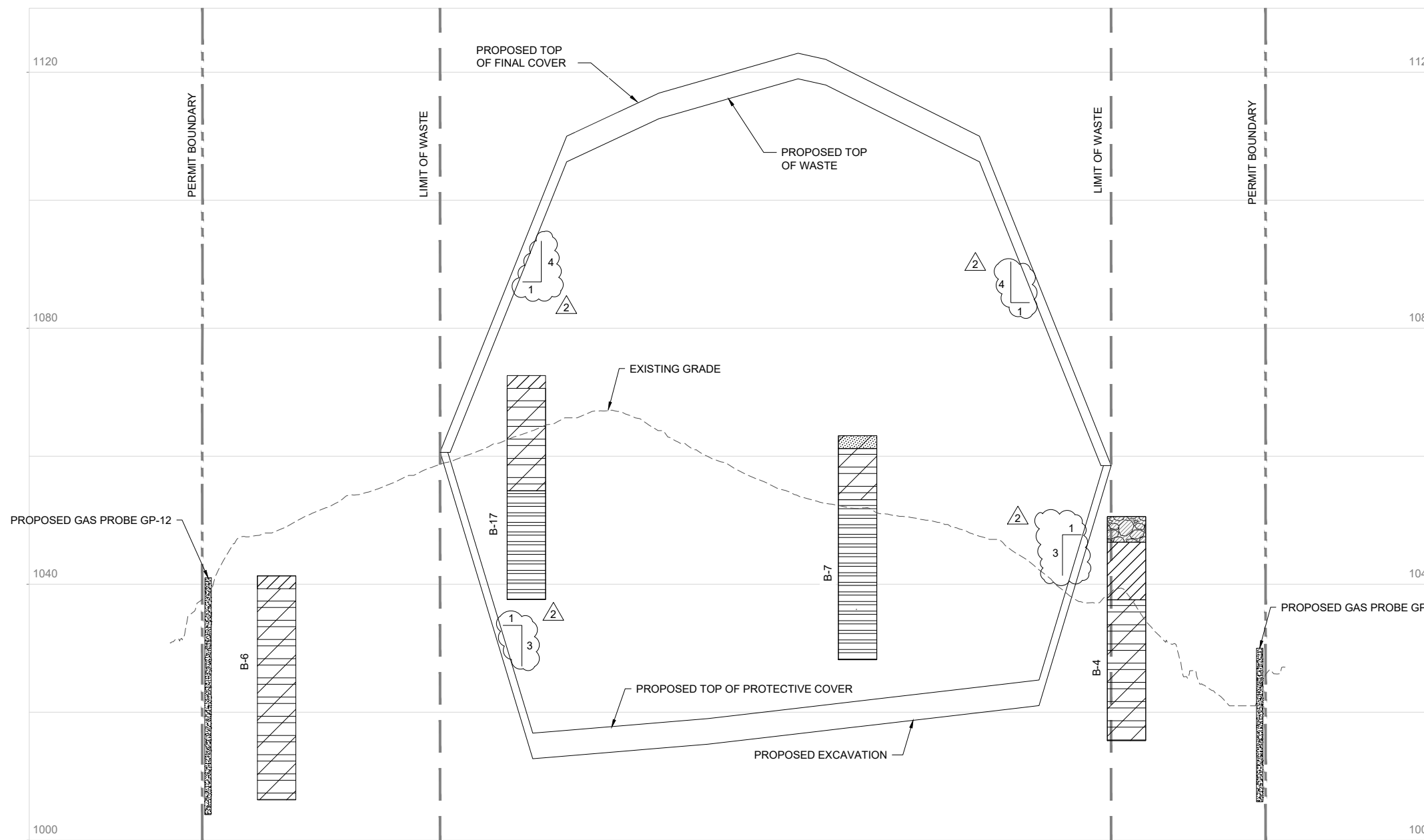
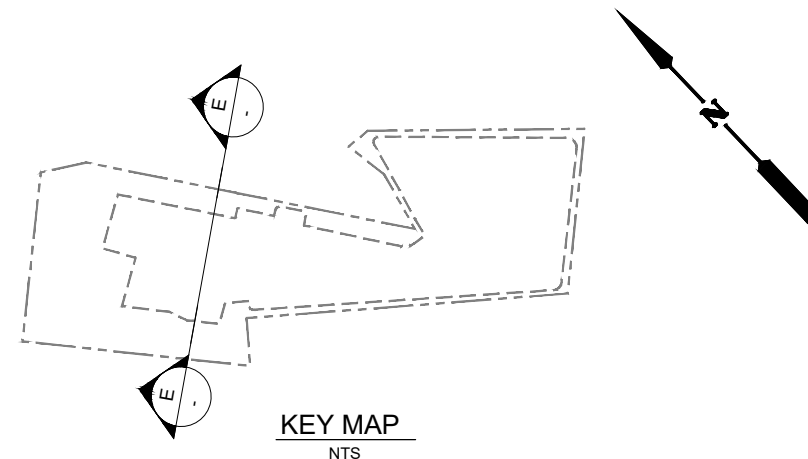

NO.	REVISION	BY	DATE
2.	2ND TECHNICAL NOD	STV	03/2025
1.	1ST TECHNICAL NOD	STV	08/2024

VERIFY SCALE BAR LENGTH EQUALS ONE INCH ON ORIGINAL DRAWING. VERIFY LENGTH ON THIS SHEET 0 1" AND ADJUST SCALE ACCORDINGLY.

CITY OF DEL RIO LANDFILL NO. 207C
MAJOR PERMIT AMENDMENT

CROSS SECTION E







DESIGN: T. METAFERIA
DRAWN: T. METAFERIA
REVIEW: B. HINDMAN
CP&Y: DELR200302
CLIENT: CITY OF DEL RIO

FIGURE
IIIA-B.8

NOTES:

1. TOPOGRAPHIC MAP WAS COMPLETED FROM PHOTOGRAMMETRIC METHODS BY DALLAS AERIAL SURVEY. VERTICAL DATUM BASED ON NGS MEAN SEA LEVEL. MAPPING COMPLETED IN ACCORDANCE WITH NATIONAL MAP ACCURACY STANDARDS.
2. REFER TO APPENDIX IIIA-A FOR LINER, LEACHATE COLLECTION, AND FINAL COVER SYSTEM DETAILS.
3. SEE APPENDIX IIIG FOR BORING DATA. BORINGS PROJECTED INTO THE LINE OF SECTION.
4. AS SHOWN IN APPENDIX I/IIC, THE BUFFER ZONES VARY AROUND THE PERIMETER OF THE SITE, BUT IN NO CASE ARE THEY LESS THAN 50-FEET FOR EXISTING WASTE.
5. REFER TO APPENDIX IIIM, FOR DETAILS OF THE LANDFILL GAS MANAGEMENT PLAN.
6. DRAINAGE DESIGN INFORMATION IS PROVIDED IN APPENDIX IIIH-SURFACE WATER DRAINAGE PLAN.
7. MAXIMUM TOP OF FINAL COVER ELEVATION IS 1124 FT-MSL.
8. REFER TO APPENDIX IIIC FOR LEACHATE COLLECTION SYSTEM (LCS) INFORMATION.
9. THE SITE DOES NOT HAVE ANY GROUNDWATER MONITORING WELLS. GROUNDWATER HAS NOT BEEN ENCOUNTERED IN OF THE BORINGS OR DURING CONSTRUCTION OF CELLS 1 THROUGH 6.
10. THIS SITE DOES NOT ACCEPT ANY CLASS 1 WASTE.

LEGEND

	PERMIT BOUNDARY
	LIMIT OF WASTE
	CLAYEY GRAVEL
	CLAY
	FAT CLAY
	WEATHERED CLAY-SHALE
	CLAY-SHALE

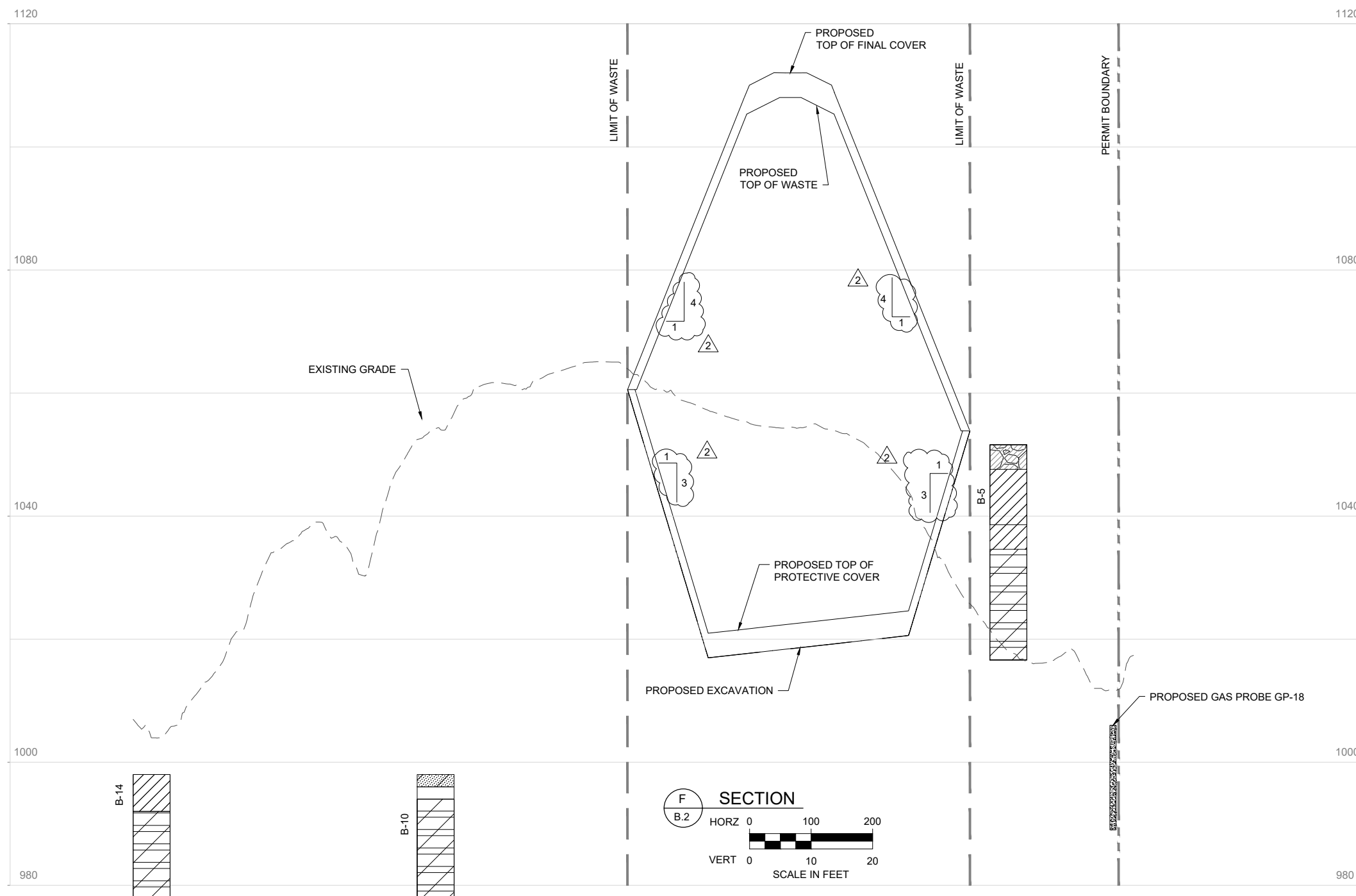
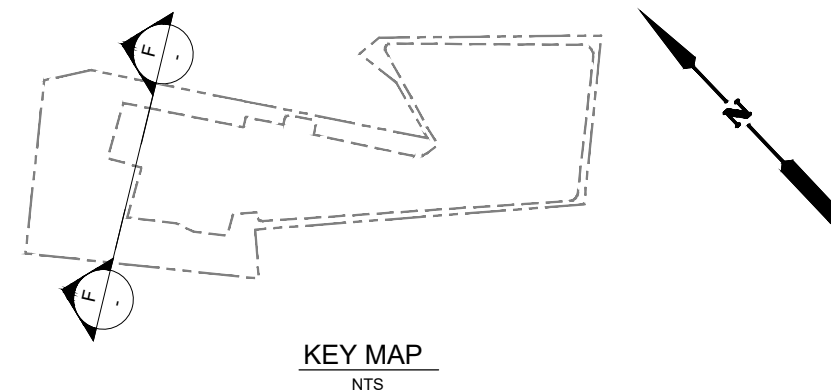

NO.	REVISION	BY	DATE
2.	2ND TECHNICAL NOD	STV	03/2025
1.	1ST TECHNICAL NOD	STV	08/2024

VERIFY SCALE BAR LENGTH EQUALS ONE INCH ON ORIGINAL DRAWING. VERIFY LENGTH ON THIS SHEET AND ADJUST SCALE ACCORDINGLY.

CITY OF DEL RIO LANDFILL NO. 207C
MAJOR PERMIT AMENDMENT

CROSS SECTION F

DESIGN: T. METAFERIA
DRAWN: T. METAFERIA
REVIEW: B. HINDMAN
CP&Y: DELR200302
CLIENT: CITY OF DEL RIO

FIGURE
IIIA-B.9

FOR PERMITTING PURPOSES ONLY

PRINTED BY: Metaferia T
FILE PATH: C:\pwworking\stvinet\delr\delr200302\Figure IIIA-B.9.dwg

CITY OF DEL RIO LANDFILL

VAL VERDE COUNTY, TEXAS
TCEQ PERMIT NO. MSW-207C

MAJOR PERMIT AMENDMENT APPLICATION PART III – SITE DEVELOPMENT PLAN

APPENDIX IIIC LEACHATE AND CONTAINATED WATER MANAGEMENT PLAN

Prepared for
City of Del Rio

September 2023
Revision 1 August 2024
Revision 2 March 2025



Tawobista Metaferia

Prepared by
CP&Y an STV Company
TPBE Registration No. F-1741
13155 Noel Road, Suite 200
Dallas, TX 75240
214-638-0500

This document is intended for permitting purposes only.

TABLE OF CONTENTS

1.0 INTRODUCTIONIIIC-1

2.0 SOIL INFILTRATION LAYER QUALITY ASSURANCE.....IIIC-1

2.1 Generation Process..... IIIC-1

2.2 Leachate Generation and Contaminated Stormwater Modeling IIIC-1

2.3 Stormwater Management IIIC-1

3.0 LEACHATE COLLECTION SYSTEMIIIC-3

3.1 System Layout and Design Criteria IIIC-3

3.1.1 Design Criteria IIIC-3

3.1.2 Leachate Collection System Layout..... IIIC-3

3.2 Leachate Collection Layer IIIC-6

3.2.1 Chimney Drains IIIC-6

3.3 Leachate Collection Piping..... IIIC-6

3.4 Leachate Sumps and Pumps IIIC-8

3.5 Drainage Stone (Coarse Aggregate)..... IIIC-10

4.0 LEACHATE AND CONTAMINATED WATER STORAGE IIIC-12

4.1 Leachate Storage IIIC-12

4.2 Contaminated Water Management..... IIIC-12

5.0 LEACHATE AND CONTAMINATED WATER DISPOSAL..... IIIC-13

5.1 Leachate Storage System Operation and Disposal IIIC-13

5.2 Contaminated Water Disposal..... IIIC-13

- Appendix IIIC-A. HELP Model Analysis**
- Appendix IIIC-B. Leachate Collection System Design Calculation**
- Appendix IIIC-C. Containment Berm Calculation**

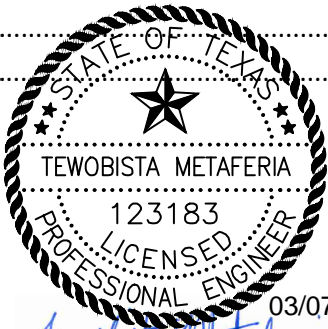

LIST OF TABLES

Table 3-1 LCS Maximum Depth of Leachate on Liner..... IIIC-5

Table 3-2 Geotextile and Drainage Geocomposite Required Testing and Properties..... IIIC-7

Table 3-3 Leachate Sump Operating Plan..... IIIC-9

Table 4-1 Sump Flow..... IIIC-12

LIST OF FIGURES

Figure IIIC-3.1 – Leachate Collection System Plan IIIC-11

1.0 INTRODUCTION

This Leachate and Contaminated Water Management Plan for the City of Del Rio Landfill was prepared consistent with Title 30 Texas Administrative Code (TAC) §§330.305(g), 330.177, 330.207, and 330.333. This plan provides the details of the collection, storage, treatment and disposal of contaminated water, and leachate generated during the active and post-closure periods of the landfill. The design details for the liner and final cover systems are included in Appendix IIIA-A - Liner, and Final Cover System Details.

2.0 LEACHATE AND CONTAMINATED WATER GENERATION

2.1 Generation Process

Leachate is generated when water percolates through the layers of solid waste as moisture is released from high moisture content waste. The capacity of solid waste to absorb moisture is known as field capacity. When the field capacity is exceeded, leachate is generated. However, leachate may also flow within the landfill through preferential pathways; therefore, some downward flow of leachate will occur before the field capacity of waste is reached. The quantity of leachate produced will depend upon the climate, site topography, type of cover, construction and landfilling procedures, and waste characteristics.

Contaminated water is defined in Title 30 TAC §330.3(36) as "leachate, gas condensate, or water that has come into contact with waste." Contaminated water is generated when stormwater runoff has come into contact with solid waste at the working face of the landfill or any other area at the site where water contacts solid waste, leachate, or gas condensate. [The SOP outlines the locations where water may come into contact with solid waste, leachate, or gas condensate. Section 33 of the SOP details the measures for containing and disposing of contaminated water.](#)

2.2 Leachate Generation and Contaminated Stormwater Modeling

The Hydrologic Evaluation of Landfill Performance (HELP) model, Version 4.0, was used to estimate the amount of leachate that will be generated at the City of Del Rio Landfill. The HELP model is a quasi-two-dimensional hydrologic model of water movement across, into, through, and out of landfills. The model uses climate, soil, and landfill design data to perform a solution technique that accounts for the effects of surface storage, runoff, infiltration, percolation, soil-moisture storage, evapotranspiration, and lateral drainage.

Leachate generation was evaluated for both active and closed landfill conditions. An explanation of the assumed conditions, methodologies, models and printouts of the results are included as Appendix IIIC-A. The leachate generation rates produced by HELP are used for the leachate collection system (LCS) design.

2.3 Stormwater Management

The City of Del Rio Landfill will manage surface water throughout the active life of the landfill to minimize the amount of stormwater that will come in contact with waste or leachate. Uncontaminated surface water will be controlled through the use of diversion berms, [and](#) stormwater diversion ditches, ~~and sumps~~. To promote runoff and prevent ponding, the operational cover will be graded and maintained.

Stormwater that comes into contact with waste will be considered contaminated water and handled consistent with Title 30 TAC §330.207. Contaminated water will be contained by the containment berm

at the working face. At no time will contaminated water be allowed to discharge into waters of the United States. Storage of contaminated water and its disposal are discussed in Section 4 and Section 5.

The final cover has been designed to minimize infiltration and promote runoff. Uncontaminated surface water will be managed throughout the active life of the landfill to minimize infiltration into the filled areas and to minimize contact with solid waste. Also, daily and intermediate cover will be graded and maintained to promote runoff and prevent ponding as described in Part IV - Site Operating Plan (SOP).

Procedures for verifying the adequacy of daily cover placement to cover all waste material is discussed in SOP, Section 27.1. Runoff generated from fill areas covered with a minimum 6 inches of earthen daily cover having no exposed waste or 12 inches of intermediate cover will be considered as uncontaminated and allowed to drain to the perimeter drainage system. In the event that the 6 inches of daily cover does not prevent stormwater from contacting solid waste or leachate, this stormwater will be collected and managed as contaminated and disposed of in an authorized manner. Uncontaminated surface water runoff will be diverted around the working face.

3.0 LEACHATE COLLECTION SYSTEM

3.1 System Layout and Design Criteria

The LCS for the Subtitle D area will consist of: (1) a collection layer placed over the liner system, (2) the leachate collection piping, and (3) the leachate collection sumps and pumps. An overliner LCS will be placed above the overliner system geomembrane liner within the pre-Subtitle D area to collect leachate generated from the waste placed in the vertical expansion area. The plan for the LCS piping and grading is shown in Part III, Appendix IIIA-A, Figures IIIA-A.1 and IIIA-A.1a. LCS details are also provided in Part III, Appendix IIIA-A - Liner and Final Cover System Details.

3.1.1 Design Criteria

The leachate management system is designed and operated to collect and remove leachate from each cell, maintain leachate levels below 12 inches (or 30 cm) above the liner systems, channel leachate to designated collection sumps, and effectively manage leachate through collection and disposal. The system is designed to eliminate potential migration of landfill leachate into the environment and to meet the following requirements of Title 30 TAC §330.333:

- constructed of materials that are chemically resistant to the leachate expected to be generated;
- of sufficient strength and thickness to prevent collapse under the pressures exerted by overlying wastes, waste cover materials, and by equipment used at the facility; and
- designed to function through the scheduled closure and post-closure period of the facility.

The LCS is designed to maintain the maximum leachate depth on the liner to less than 12 inches, in accordance with 30 TAC §330.331(a)(~~12~~). The leachate levels will be monitored and manually pumped to maintain the required levels. The drainage geocomposite leachate collection layer is designed to convey the estimated peak leachate flow rate without the leachate level within the geocomposite exceeding the thickness of the geocomposite. The operation of the leachate sump and the conveyance capacity of the geocomposite leachate collection layer work in tandem to maintain compliance with the design standard listed in Title 30 TAC §330.331(a)(~~21~~). The LCS piping network is designed to convey collected leachate to the leachate collection sumps. The LCS piping is designed for post-settlement slopes and to meet each of the three criteria listed above.

The geotextiles used for the geocomposite drainage layer utilize 100% continuous-filament polyester or polypropylene. Extensive testing, including EPA 9090 for chemical resistance, has demonstrated that polyester and polypropylene are resistant to a wide range of chemical classes encountered in soil and to typical leachate. The LCS piping and the geonet portion of the geocomposite are constructed of polyethylene. Polyethylene is an industry standard material and is resistant to a wide range of chemical constituents, including those typically found in leachate.

3.1.2 Leachate Collection System Layout

The LCS layout is shown on Figure IIIC-3.1. Subtitle D Cells 1 - 6 have been constructed to date. For the constructed Subtitle D cells, the leachate collection layer includes a geocomposite placed over the liner system to collect and transfer leachate to the leachate collection pipes and sumps. The currently constructed LCS has been evaluated considering the leachate collection layer and leachate collection header pipe grades under the proposed landfill expansion conditions (i.e., after landfill foundation

3.4 Leachate Sumps and Pumps

The leachate collection sumps and pumps have been sized to comply with the regulatory design standard listed in §330.331(a)(12). The leachate collection sumps and pumps have been designed to maintain less than 12 inches (30 cm) depth of leachate over the liner. The leachate sump operating plan is included in Table 3-3.

Each leachate sump will be sized based on the amount of leachate generation taking into consideration the contributing area from the Subtitle D cells. The minimum sump size for the undeveloped cells and overliner will be 2 feet deep with minimum dimensions of approximately 27 by 27 feet at the landfill floor and 15 by 15 feet at the sump base and will store a minimum of 906 cubic feet of leachate. The size and capacity of the sumps are presented in Appendix IIIC-B. New sump will be backfilled with drainage stone meeting the gradation in accordance with ASTM D 448, size number 467 (nominal aggregate size is 2 inches to 3/16 inches). Each sump will be emptied by a submersible pump located in an 18-inch nominal diameter sidewall riser pipe which extends into the bottom of the sump and is perforated in the sump. Pumps will be operated manually. Control levels for the pump will be set to maintain sump liquid levels between the lip of the sump and pump intake. The objective of the pump operation is to ensure that a free-flowing condition is maintained in the LCS. If the pump malfunctions, the pump will be removed, repaired, and replaced, or a new pump will be used (see Table 3-3 for additional information). If it is determined that the pump is malfunctioning, it will be removed and replaced immediately. In addition, the pumps will be replaced when it is determined that a larger capacity pump is needed based on existing conditions. The leachate depth monitoring procedure and leachate removal will be the same for all disposal areas.

The specified pump will have the capacity to pump leachate at a rate of 20 gpm or 28,800 gpd. The maximum estimated flow to be pumped from the largest cell is 745 gpd. If the specified leachate sump pumps are not able to empty the sump and maintain less than 12 inches of head on the liner at reasonable cycle times, then a pump with more capacity will be used (refer to Section 4.1 for more information).

Table 3-3 Leachate Sump Operating Plan

Leachate Level Description	Condition	Action Required
Leachate level between lip of sump and pump intake at the bottom of the sump.	System is functioning as designed. The drainage geocomposite leachate collection layer installed on the floor of the landfill is designed to convey the estimated peak leachate flow rate without the leachate level within the geocomposite exceeding the thickness of the geocomposite. The operation of the leachate sump and the conveyance capacity of the geocomposite leachate collection layer work in tandem to maintain compliance with the design standard listed in §330.331(a)(12).	The depth of leachate in the sump is monitored by a landfill personnel at least 41 times per week month. Leachate flow to the sump and sump pump capacity are listed in Table 4-1. The sump design is discussed in Section 3.4.
Leachate level between the lip of the sump and 0.0212 inches (0.0539 cm) above the lip of the sump.	The 0.0212 -inch design standard listed in <u>Appendix IIIK per</u> §330.331(a)(12) has not been exceeded.	For these two conditions, the sump operation will be monitored daily until the leachate is pumped out by the Operator. For both conditions, the leachate levels in the sump will be recorded daily. If it is determined that the pump is malfunctioning, it will be removed and replaced immediately. In addition, the pumps will be replaced when it is determined that a larger capacity pump is needed based on existing conditions.
Leachate level over 0.0512 inches above the lip of the sump.	The design standard listed in <u>Appendix IIIK per</u> §330.331(a)(12) has been exceeded.	As noted in the EPA Technical Manual Solid Waste Disposal Facility Criteria, EPA530-R-93-017, "The 30-cm head allowance is a design standard and the [EPA] recognizes that this design standard may be exceeded for relatively short periods of time during the active life of the unit."

CITY OF DEL RIO LANDFILL

VAL VERDE COUNTY, TEXAS

TCEQ PERMIT NO. MSW-207C

MAJOR PERMIT AMENDMENT APPLICATION PART III – SITE DEVELOPMENT PLAN

APPENDIX IIIC-A HELP MODEL ANALYSIS

Prepared for
City of Del Rio

September 2023
Revision 1 August 2024
[Revision 2 March 2025](#)



Prepared by
CP&Y an STV Company
TPBE Registration No. F-1741
13155 Noel Road, Suite 200
Dallas, TX 75240

This document is intended for permitting purposes only.

TABLE OF CONTENTS

1.0 INTRODUCTION IIIC-A-1

2.0 HELP MODEL SETUP IIIC-A-1

2.1 Moisture Content And Field Capacity IIIC-A-2

2.2 Climate Data Input IIIC-A-2

2.3 Landfill Profile IIIC-A-3

2.3.1 Liner Systems IIIC-A-3

2.3.2 Leachate Collection System IIIC-A-3

2.3.3 Waste Layers IIIC-A-3

2.3.4 Intermediate Cover IIIC-A-3

2.3.5 Final Cover IIIC-A-3



2.3 Landfill Profile

The landfill profiles for various stages of the landfill development are presented in the attached HELP Model summary sheets. The profile presented below includes a clay liner with a standard Subtitle D final cover system.

2.3.1 Liner Systems

The Subtitle D clay liner designed for developed and undeveloped cells consists of a 24-inch-thick compacted clay liner with a hydraulic conductivity of 1×10^{-7} cm/s. Default soil characteristics from the HELP model were selected for the compacted clay liner.

2.3.2 Leachate Collection System

Developed Subtitle D Cells 1 through 6 were constructed with an LCS that includes a 200-mil thick single-sided geocomposite for floor grades and double-sided geocomposite for the sideslopes. Cells 7 through 10 will be constructed with a 250-mil thick single-sided geocomposite for floor grades and double-sided geocomposite for the sideslopes.

2.3.3 Waste Layers

Various waste thicknesses were modeled to represent the various stages of landfill development in the Subtitle D and pre-subtitle D areas. A default wilting point was selected from HELP to represent municipal solid waste. The waste column was split into two layers. The top 50-foot layer was modeled with a hydraulic conductivity of 1×10^{-3} cm/s. The moisture content, field capacity, and porosity values were selected as discussed previously.

2.3.4 Intermediate Cover

The intermediate cover consists of a 12-inch-thick layer of soil placed over the waste. Default soil characteristics were selected from HELP to represent the available onsite soils with a hydraulic conductivity of 6.4×10^{-5} cm/s.

2.3.5 Final Cover

The final cover over the Subtitle D and pre-Subtitle D areas consists of a 12-inch erosion layer with the top 6 inches capable of sustaining growth of vegetation and an 18-inch infiltration layer. The infiltration layer consists of compacted soil with a hydraulic conductivity of 1×10^{-5} cm/s. [The site is modeled using \$1 \times 10^{-5}\$ hydraulic conductivity and provides a conservative design.](#)

CITY OF DEL RIO LANDFILL

VAL VERDE COUNTY, TEXAS
TCEQ PERMIT NO. MSW-207C

MAJOR PERMIT AMENDMENT APPLICATION PART III – SITE DEVELOPMENT PLAN

APPENDIX IIIIE CLOSURE PLAN

Prepared for
City of Del Rio

September 2023
Revision 1 August 2024
Revision 2 March 2025



Teobista Metaferia

Prepared by
CP&Y an STV Company
TPBE Registration No. F-1741
13155 Noel Road, Suite 200 Dallas, TX 75240
214-638-0500

This document is intended for permitting purposes only.

TABLE OF CONTENTS

1.0 INTRODUCTION III E-1

2.0 FINAL COVER SYSTEM III E-3

2.1 Introduction III E-3

2.2 Final Cover System Design III E-3

2.3 Installation Methods and Procedures..... III E-4

3.0 CLOSURE PROCEDURES III E-5

3.1 Sequence of Final Cover Placement III E-5

3.2 Landfill Unit Closure During Active Life III E-5

3.2.1 Estimate of Largest Active Disposal Area III E-6

3.2.2 Estimate of Maximum Inventory of Waste Ever on Site III E-6

3.3 Leachate Management III E-6

4.0 SCHEDULE OF UNIT AND FACILITY FINAL CLOSURE III E-7

4.1 Landfill Closure Requirements III E-7

4.2 Provisions for Extending Closure Period III E-8

Appendix III E-A FINAL COVER SYSTEM QUALITY CONTROL PLAN

Appendix III E-B TCEQ FORM 20720

Appendix III E-C CELLS 1 AND 2 CLOSURE APPROVAL

LIST OF TABLES

Table 4-1 Landfill Closure Schedule III E-9

LIST OF FIGURES

Figure III E.1 Landfill Closure Plan III E-2



2.0 FINAL COVER SYSTEM

2.1 Introduction

The final cover system for the City of Del Rio Landfill has been developed to incorporate the requirements of Title 30 TAC §330.457(f)(4). The rules state that the owner or operator of a MSW landfill unit shall complete closure activities for the unit in accordance with the approved closure plan within 180 days following the initiation of closure activities (closure activities for MSW landfill units shall begin no later than 30 days after the date on which the unit receives the known final recent receipt of wastes, or, if the unit has remaining capacity and there is a reasonable likelihood that the unit will receive additional wastes, no later than one year after the most receipt of wastes). Such a system will include installation of a final cover system and a storm water runoff control system. The storm water runoff controls are addressed in Appendix IIIH – Surface Water Drainage Plan. The final cover system design is discussed below and is also detailed in Appendix IIIA-A. Cross-sections are provided in Appendix IIIA-B.

2.2 Final Cover System Design

The final cover system will consist of a cover system for both pre-Subtitle D and Subtitle D areas. The final cover system will provide a low maintenance cover, protect against erosion, reduce rainfall percolation through the cover system and subsequently minimize leachate generation within the landfill. As depicted on Figure IIIE-1, a maximum slope of 5 percent is provided for the top slopes. Side slopes of the final cover for all above-ground disposal areas are 4H:1V and will not exceed a 25% grade. The top and side slopes specified are sufficient grades to preclude ponding of surface water when total fill height and expected subsidence are taken into consideration.

Subtitle D Composite Final Cover System

- An erosion layer consisting of a earthen material capable of sustaining vegetative growth. The vegetation will consist of native or introduced grasses, as well as a mixture of Bermuda, vetch, rye, wheat grass, wildflowers, and other flowering plants capable of providing 90 percent coverage over the cover system. The erosion layer will be 12-in thick on the top slope and 24-in thick on the sideslopes.
- An 18-inch-thick compacted clay infiltration layer with a coefficient of permeability of less than or equal to 1×10^{-25} cm/s.

The low permeability component of the final cover system (the 18-inch-thick clay infiltration layer) is designed to minimize infiltration of surface water into the underlying waste material. Details of the final cover system are shown on Drawings A.6 and A.7 in Appendix IIIA-A. Material specifications, construction, and testing procedures are provided in Appendix IIIE-A Final Cover System Quality Control Plan.

Vegetation will be established over the installed final cover system to minimize the erosion potential of the cover slopes. The erosion layer was evaluated using the universal soil loss equation (USLE) developed by the United States Department of Agriculture (USDA) Natural Resources Conservation Service (NRCS). The evaluation is presented in Appendix IIIH – Surface Water Drainage Plan.

Landfill gas generated in the landfill will be managed as discussed in Appendix IIIM – Landfill Gas Management Plan. The landfill gas system will monitor the gas generated by deposited waste.

Similar to the proposed final cover areas, permanent final cover erosion control structures include swales and chutes that will be constructed on the existing final cover. [Swales shall be constructed at every 180 feet or less and shall not exceed a length of 578 feet.](#) The design of the final cover system erosion control structures is provided in Appendix IIIH-B. A soil loss and sheet flow velocity demonstration for the erosion layer is included in Appendix IIIH-D – Erosion Layer Evaluation. [A minimum of 90% vegetation cover shall be maintained for final cover.](#)

2.3 Installation Methods and Procedures

The final cover system will be constructed in accordance with the requirements listed on the permit drawings in Appendix IIIA-A and the Final Cover System Quality Control Plan presented in Appendix IIIE-A. Testing and evaluation of the final cover system during construction will be in accordance with Appendix IIIE-A.

CITY OF DEL RIO LANDFILL

VAL VERDE COUNTY, TEXAS
TCEQ PERMIT NO. MSW-207C

MAJOR PERMIT AMENDMENT APPLICATION PART III – SITE DEVELOPMENT PLAN

APPENDIX IIIE-A FINAL COVER SYSTEM QUALITY CONTROL PLAN

Prepared for
City of Del Rio

September 2023
Revision 1 August 2024
[Revision 2 March 2025](#)



Prepared by
CP&Y an STV Company TPBE Registration No. F-1741
13155 Noel Road, Suite 200 Dallas, TX 75240
214-638-0500

This document is intended for permitting purposes only.

TABLE OF CONTENTS

1.0 INTRODUCTION III E-A-1

 1.1 Purpose III E-A-1

 1.2 Definitions..... III E-A-1

2.0 CONSTRUCTION QUALITY ASSURANCE FOR SOIL INFILTRATION LAYER III E-A-4

 2.1.1 Introduction III E-A-4

 2.2 Final Cover III E-A-4

 2.3 Soil Infiltration Layer Construction III E-A-4

 2.3.1 Intermediate Cover III E-A-4

 2.3.2 Soil Infiltration Layer III E-A-4

 2.3.3 Structural Fill III E-A-7

 2.3.4 Surface Water Removal..... III E-A-8

 2.4 Construction Testing..... III E-A-8

 2.4.1 Standard Operating Procedures..... III E-A-8

 2.4.2 Test Frequencies III E-A-8

 2.5 Reporting III E-A-8

3.0 CONSTRUCTION QUALITY ASSURANCE FOR EROSION LAYER III E-A-10

4.0 DOCUMENTATION III E-A-11

 4.1 Preparation of FCSE III E-A-11

 4.2 Reporting Requirements..... III E-A-11

LIST OF TABLES

Table 2-1 Standard Tests on Infiltration Layer Soils III E-A-9



- Liquid Limit equal to or greater than 30.
- Percent passing the No. 200 mesh sieve equal to or greater than 30 percent.
- Percent passing the 1-inch screen equal to 100 percent.
- Coefficient of permeability of less than or equal to 1×10^{-5} cm/s.

The soil infiltration layer material will consist of relatively homogeneous clay, and clayey soils. The soil will be free of debris, rock greater than 1 inch in diameter, vegetative matter, frozen materials, foreign objects, and organics. Testing will be performed in accordance with Section 2.4 (refer to Table 2-1 for test methods) for each borrow source. A permeability test will be conducted on samples from each borrow source. The permeability test specimens will be prepared by laboratory compaction to a dry density of approximately 95 percent of the Standard Proctor (ASTM D 698) maximum dry density at a moisture content at or above the optimum moisture content. One Proctor moisture-density relationship and remolded permeability test will be required for each different material as determined by a change in the liquid limit or plasticity index of more than 10 points.

The material will be compacted to a minimum of 95 percent of the maximum dry density determined by Standard Proctor (ASTM D 698) at a moisture content between the Standard Proctor optimum and 5 percentage points above optimum. The CQA monitor, earthwork contractor, and/or Operator will identify the clay material during excavation, and the clay material will be stockpiled separately, if stockpiling is required.

Because of possible variability of the available clay materials, additional stockpile testing will be performed if different physical properties of the borrow soil (color, texture, etc.) are observed by the CQA monitor, and the materials vary by more than ten points in either liquid limit or plasticity index from previously evaluated materials.

The clay materials to be used for infiltration layer will require processing to achieve the required moisture content for compaction. The physical characteristics of the clay materials will be evaluated through visual observation before and during construction. To add moisture to the material properly, the clod sizes will first be crushed into manageable sizes of 1 inch in diameter or less. Rocks within the infiltration layer should be less than 1 inch in diameter and will not total more than 10 percent by weight.

Clod-size reduction, if necessary, may be achieved using a disc harrow or soil pulverizer. To efficiently break down the clods, multiple passes of the processing equipment in two directions are recommended. Water will be applied as necessary to the material and worked into the material with the processing or compacting equipment. If necessary, to achieve even moisture distribution or break down clod, the material will be watered and processed in the stockpile prior to placing in the infiltration layer to allow the soil adequate time to hydrate. Water used for the soil infiltration layer must be clean and not contaminated by waste or any objectionable material. Collected onsite stormwater may be utilized if it has not come into contact with the solid waste.

The soil infiltration layer must be compacted with a pad/tamping-foot or prong-foot (sheepsfoot) roller. The lift thickness will be controlled so that there is total penetration through the loose lift under compaction into the top of the previously compacted lift; therefore, the lift thickness must not be greater than the pad or prong length. The top of intermediate cover will be scarified a minimum of two inches prior to placement of the first lift of soil infiltration layer. Use of pad/tamping foot or prong-foot rollers will provide sufficient roughening of soil infiltration layer lift's surface for bonding between lifts. These procedures are necessary to achieve adequate bonding between lifts and reduce seepage pathways.

Appendix III E-B TCEQ FORM 20720

Closure Plan for Type I Landfill Unit and Facility

Facility Name: City of Del Rio Landfill

Revision No.:2

Permit No: 207C

Date:03/07/2025

C. Drawings Showing Details of the Waste Management Units at Closure

Table 4. Location of the Drawings showing Details of the Waste Management Units at Closure (outlines, dimensions, maximum elevations of waste and final cover of landfill units, and waste storage or processing units or operations at closure of the facility).

Drawing Location in the SDP	Drawing Figure Number	Drawing Title	Waste Management Units Details Shown
Part III, App. IIIA-B	B.2	Excavation Plan	Waste footprint, permit boundary, and dimensions of the landfill cells
Part III, App. IIIA-B	B.3	Completion Plan	Final cover plan, maximum elevations of waste and final cover of the landfill, waste footprint, permit boundary

III. Description of the Final Cover System Design**A. Types and Descriptions of the Final Cover Systems**

Table 5. Types and Descriptions of the Final Cover Systems Permitted or Proposed for Closure of the Landfill Units.

Landfill Unit Name or Descriptor	Type of Final Cover System	Final Cover System Components Description	Other Information (Enter other information as applicable)
City of Del Rio Landfill	Low-permeability soil	The final cover is comprised of 18" low permeability (1×10^{-5} cm/sec) soil infiltration layer and a 12" erosion layer.	

Closure Plan for Type I Landfill Unit and Facility

Facility Name: City of Del Rio Landfill
Permit No: 207C

Revision No.:2
Date:03/07/2025

VII. Professional Engineer’s Statement, Seal, and Signature

Name: **Tewobista Metaferia**

Title: **Project Engineer**

Date: **March 7, 2025**~~August 7, 2024~~

Company Name: **CP&Y an STV Company**

Firm Registration Number: **F-1741**

Professional Engineer’s Seal



Signature

CITY OF DEL RIO LANDFILL

VAL VERDE COUNTY, TEXAS

TCEQ PERMIT NO. MSW-207C

MAJOR PERMIT AMENDMENT APPLICATION PART III – SITE DEVELOPMENT PLAN

APPENDIX IIIF POST-CLOSURE CARE PLAN

Prepared for
City of Del Rio

September 2023
Revision 1 August 2024
[Revision 2 March 2025](#)



Teobista Metaferia

Prepared by
CP&Y an STV Company
TPBE Registration No. F-1741
13155 Noel Road, Suite 200
Dallas, TX 75240
214-638-0500

This document is intended for permitting purposes only.

TABLE OF CONTENTS

1.0 INTRODUCTION IIF-1



Post-Closure Care Plan for Type I Landfill Units and Facility

Facility Name: City of Del Rio Landfill

Revision No.:2

Permit No: 207C

Date: 03/07/2025

throughout the post-closure care period. TCEQ staff will have access to the site to conduct inspection or investigation that may be necessary during the period.

2. Inspection Activities and Correction of Problems

The site operator will conduct inspection of the closed landfill units at the frequencies indicated in Table 3 below, utilizing the inspection protocol maintained in the site operating record, and will correct all identified problems as needed.

Table 3: Inspection Activities Schedule

Post-Closure Care Inspection Item	Frequency of Inspection	Types of Deficiency Conditions to be looked for during Inspection
Final Cover Condition	Weekly and within 72-hours of a rainfall event of 0.5 inches or more.	Inspect for proper placement, thickness, compaction, slope, settlement and erosion. Maintenance will be ongoing throughout post-closure care period. Correct problems as needed.
Vegetation	Weekly and within 72-hours of a rainfall event of 0.5 inches or more.	Inspect for proper placement, thickness, compaction, slope, settlement and erosion. Maintenance will be ongoing throughout post-closure care period. Correct problems as needed. A minimum of 90% vegetation cover shall be maintained.
Leachate Management Systems	Weekly for sump and monthly for caps	Measure depth of leachate in sump, as required and Inspect the caps and piping of the cleanout riser and sump riser of the leachate collection system to prevent potential odor escape.
Landfill Gas Monitoring and Control Systems	Quarterly	Samples of gas from probes installed at evenly spaced intervals not to exceed 1000 feet will be analyzed and checked against the allowable maximum of the LEL (lower explosive limit). Methane detection for on-site structures is also conducted in accordance with the Methane Detection Plan.
Groundwater Monitoring Systems	N/A	Site currently does not have a groundwater monitoring system.
Drainage Structures	Weekly and within 72-hours of a rainfall event of 0.5 inches or more.	Inspect perimeter channels and berms/dikes to verify that they are functioning as designed.

Post-Closure Care Plan for Type I Landfill Units and Facility

Facility Name: City of Del Rio Landfill

Revision No.:2

Permit No: 207C

Date: 03/07/2025

XI. Engineer's Seal and Signature

Name: **Tewobista Metaferia, P.E.** Title: **Project Manager**

Date: 03/07/2025

Company Name: **CP&Y an STV Company** Firm Registration Number: **F-1741**

Professional Engineer's Seal



Signature

CITY OF DEL RIO LANDFILL

VAL VERDE COUNTY, TEXAS
TCEQ PERMIT NO. MSW-207C

MAJOR PERMIT AMENDMENT APPLICATION PART III – SITE DEVELOPMENT PLAN

APPENDIX III G CLOSURE AND POST-CLOSURE CARE COST ESTIMATE

Prepared for
City of Del Rio

September 2023
Revision 1 August 2024
[Revision 2 March 2025](#)



Prepared by
CP&Y an STV Company
TPBE Registration No. F-1741
13155 Noel Road, Suite 200
Dallas, TX 75240
214-638-0500

This document is intended for permitting purposes only.

TABLE OF CONTENTS

1.0 INTRODUCTION III-G-1
Appendix III-G-A TCEQ Forms 20721 and 20723

LIST OF TABLES

Table 1-1 Closure Cost Estimates..... III-G-2
Table 1-2 Post-Closure Cost Estimates III-G-3

LIST OF FIGURES

Figure III-G.1 Area Requiring Final Cover III-G-4



Appendix III G-A. TCEQ Forms 20721 and 20723



Texas Commission on Environmental Quality Post-Closure Care Cost Estimate Form for Municipal Solid Waste Type I Landfills

This form is for use by applicants or site operators to provide post-closure care cost estimates for post-closure care of MSW Type I landfills to meet the requirements in 30 Texas Administrative Code (TAC) Chapter 330, Section 330.63(j) and 30 TAC Chapter 330 Subchapter L. The costs to be provided herein are cost estimates for hiring a third party to conduct post-closure care of the largest waste fill area that has been certified closed in writing by the TCEQ executive director.

If you need assistance in completing this form, please contact the MSW Permits Section in the Waste Permits Division at (512) 239-2335.

I. General Information

Facility Name: **City of Del Rio Landfill**

MSW Permit No.: **207C**

Date: **03~~08~~/07~~07~~/2025~~4~~**

Revision Number: **2~~1~~**

Site Operator/Permittee Name and Mailing Address: **City of Del Rio 114 W Martin St
Del Rio, TX 78840**

Total Post-Closure Care Cost Estimate (2023 Dollar Amount): **\$2,269,302.30**

II. Professional Engineer's Statement, Seal, and Signature

I am a licensed professional engineer in the State of Texas. To the best of my knowledge, this Post-Closure Care Cost Estimate has been completed in substantial conformance with the facility Post-Closure Care Plan and, in my professional opinion, is in compliance with Title 30 of the Texas Administrative Code, Chapter 330.

Name: **Tewobista Metaferia, P.E.** Title: **Project Engineer**

Date: **03~~08~~/07~~07~~/2025~~4~~**

Company Name: **CP&Y as STV Company** Firm Registration Number: **F-1741**

Professional Engineer's Seal

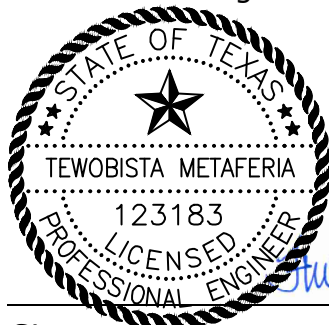

03/07/2025

Tewobista Metaferia

Signature

Post-Closure Care Cost Estimate for MSW Type I Landfills

Facility Name: City of Del Rio Landfill

Revision No.: 2

Permit No: 207C

Date: 03/07/2025

Item No.	Item Description	Units	Annual Qty.	Unit Cost	Annual Cost	Source of Unit Cost Estimate ⁱ
4.0 Sum of Engineering, Construction, and Leachate Management Costs						
4.1	Sum of Engineering, Construction, and Leachate Management Cost Subtotals				\$2,017,157.60	
5.0 Contingency						
5.1	Contingency (10% of Sum of Engineering, Construction, and Leachate Management Cost Subtotals)				\$201,715.76	
6.0 Third Party Administration and Project Management Costs						
6.1	Third Party Administration and Project Management Costs (2.5% of Sum of Engineering, Construction, and Leachate Management Cost Subtotals)				\$50,428.94	
7. Total Post-Closure Cost						
7.1	Total Annual Post-Closure Cost (Sum of amounts in Sections 4, 5, and 6)				\$2,269,302.30 5,643.41	
7.2	30 Year Post-Closure Costs (Total Annual Post-Closure Cost x 30)				\$2,269,302.30 8,079,069.00	

ⁱ Sources of Unit Cost Estimates may include:

- (1) Published Cost Estimator Manuals (e.g., RS Means);
- (2) Third Party Quotes (e.g., Environmental Field Services Contractors); or
- (3) Verifiable Data based on Actual Operations

ⁱⁱ Example Description for Item No. 1.1 – “Includes costs for site inspection performed at least annually for identification of areas experiencing settlement or subsidence, erosion or other drainage-related problems, inspection of the leachate collection system, gas monitoring system and LFG monitoring system.”

CITY OF DEL RIO LANDFILL

VAL VERDE COUNTY, TEXAS

TCEQ PERMIT NO. MSW-207C

MAJOR PERMIT AMENDMENT APPLICATION PART III – SITE DEVELOPMENT

APPENDIX IIIH SURFACE WATER DRAINAGE PLAN

Prepared for
City of Del Rio

September 2023
Revision 1 August 2024
[Revision 2 March 2025](#)

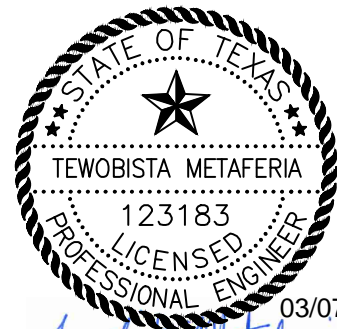

03/07/2025

Teowobista Metaferia

Prepared by
CP&Y an STV Company
TPBE Registration No. F-1741
13155 Noel Road, Suite 200
Dallas, TX 75240
214-638-0500

This document is intended for permitting purposes only.

TABLE OF CONTENTS

1.0 INTRODUCTION IIIH-1

2.0 SITE STORMWATER MANAGEMENT..... IIIH-1

2.1 Drainage System Layout IIIH-1

2.2 Erosion and Sedimentation Control Plan..... IIIH-2

2.3 Stormwater System Maintenance Plan IIIH-2

3.0 DRAINAGE SYSTEM DESIGN..... IIIH-4

3.1 Methodology..... IIIH-4

3.2 Hydrologic Analysis..... IIIH-4

3.2.1 Description of Computer Program IIIH-4

3.2.2 Watershed Subareas and Schematization IIIH-4

3.2.3 Time Step..... IIIH-4

3.2.4 Hypothetical Precipitation IIIH-4

3.2.5 Precipitation Losses..... IIIH-5

3.2.6 Hydrograph Information IIIH-5

3.3 Hydraulic Analysis IIIH-6

3.3.1 Swale and Channel Analysis IIIH-6

3.3.2 Drainage Letdown Structure (or Chute) Analysis..... IIIH-7

4.0 DRAINAGE PATTERNS..... IIIH-8

4.1 Site Drainage Patterns IIIH-8

4.2 Comparison of Permitted and Post-Development Analyses IIIH-8

4.2.1 Peak Flow Rates IIIH-9

4.2.2 Volumes..... IIIH-9

4.2.3 Velocities IIIH-9

4.2.4 Summary IIIH-9

- Appendix IIIH-A Permitted Condition Hydrologic Calculations**
- Appendix IIIH-B Post-Development Condition Hydrologic Claculations**
- Appendix IIIH-C Channel and Poind Design**
- Appendix IIIH-D Final Cover Erosion Control Structure Design ~~Erosion Layer Evaluation~~**
- Appendix IIIH-E Erosion Layer Evaluation**



LIST OF TABLES

Table 4-1 Summary of 25-Year Hydrologic Analysis IIIH-10

LIST OF FIGURES

Figure IIIH.1 – Site Drainage Pattern Runon/Runoff IIIH-11
Figure IIIH.2 – Drainage Structure Plan..... IIIH-12
Figure IIIH.3 – Drainage Details I..... IIIH-13
Figure IIIH.4 – Drainage Details II..... IIIH-14
Figure IIIH.5 – Drainage Details III..... IIIH-15
Figure IIIH.6 – Drainage Details VI..... IIIH-16
Figure IIIH.7 – Drainage Details V..... IIIH-17



4.2.1 Peak Flow Rates

As shown on Figure IIIH.1 and Table 4-1, the peak flow rates entering the permit boundary from OA1 and OA2 are identical for the permitted and post-development conditions. As discussed above, the offsite drainage areas are assumed to be identical for both conditions. Stormwater that enters the site from an off-site area and stormwater that is generated from within the permit boundary discharges at five separate locations along the permit boundary (DC1, DC2, DC3, DC4 and DC5 as shown on Figure IIIH.1). At these discharge points, the peak flow rates from the 25-year and 100-year frequency storm events that are discharged from the site for the post-development condition are all less than the permitted conditions.

4.2.2 Volumes

As shown on Figure IIIH.1, the volumes entering the permit boundary are consistent for the permitted and post-development landfill conditions. Runoff volumes are obtained from the hydrologic models and tabulated for each discharge point. The volume calculations are provided in Appendix IIIH-A and IIIH-B for the existing and post-development conditions respectively. As shown in Table 4-1, all the proposed condition volume runoff are less than the permitted condition. Therefore, the expansion does not adversely alter the existing volume runoff condition in this area.

4.2.3 Velocities

A summary of the 100-year frequency storm peak flow velocities that enter and exit the site are shown on Figure IIIH.1. As shown, the velocities at each discharge point are lower for the post-development condition compared to the permitted conditions except Discharge Point 4. [Rip rap apron Energy dissipaters](#) will be placed at the outlet structure to decrease the velocity prior to leaving the permit boundary. [The calculations for the erosion control methods are included in Appendix IIIH-C.](#) No adverse condition is created by the proposed condition. Velocity calculations are provided in Appendices IIIH-A and IIIH-B for the permitted conditions and post-development, respectively.

4.2.4 Summary

From the hydrologic evaluations of the permitted and proposed conditions, the existing drainage conditions at the permit boundary will not be adversely altered by the proposed development. Given that: (1) drainage patterns are not adversely altered, (2) design stormwater peak discharge rate at each of the discharge locations is less than the permitted discharge rate (and the post-development peak flows entering the site are equal to the permitted peak flows entering the site), (3) total volume of stormwater entering and leaving the permit boundary does not increase, and (4) the stormwater discharge outfall locations are consistent with the permitted configuration, it is concluded that the proposed landfill development will not adversely alter permitted drainage patterns consistent with Title 30 TAC 330.63(c)(1)(C), §330.63(c)(1)(D)(iii), and §330.305(a).

PRINTED BY: Metaferia
 FILE PATH: C:\pwworking\st\metaferia\0942276\DEL200302\Figure III.H.1.dwg

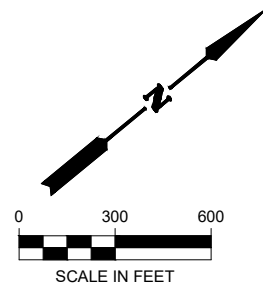
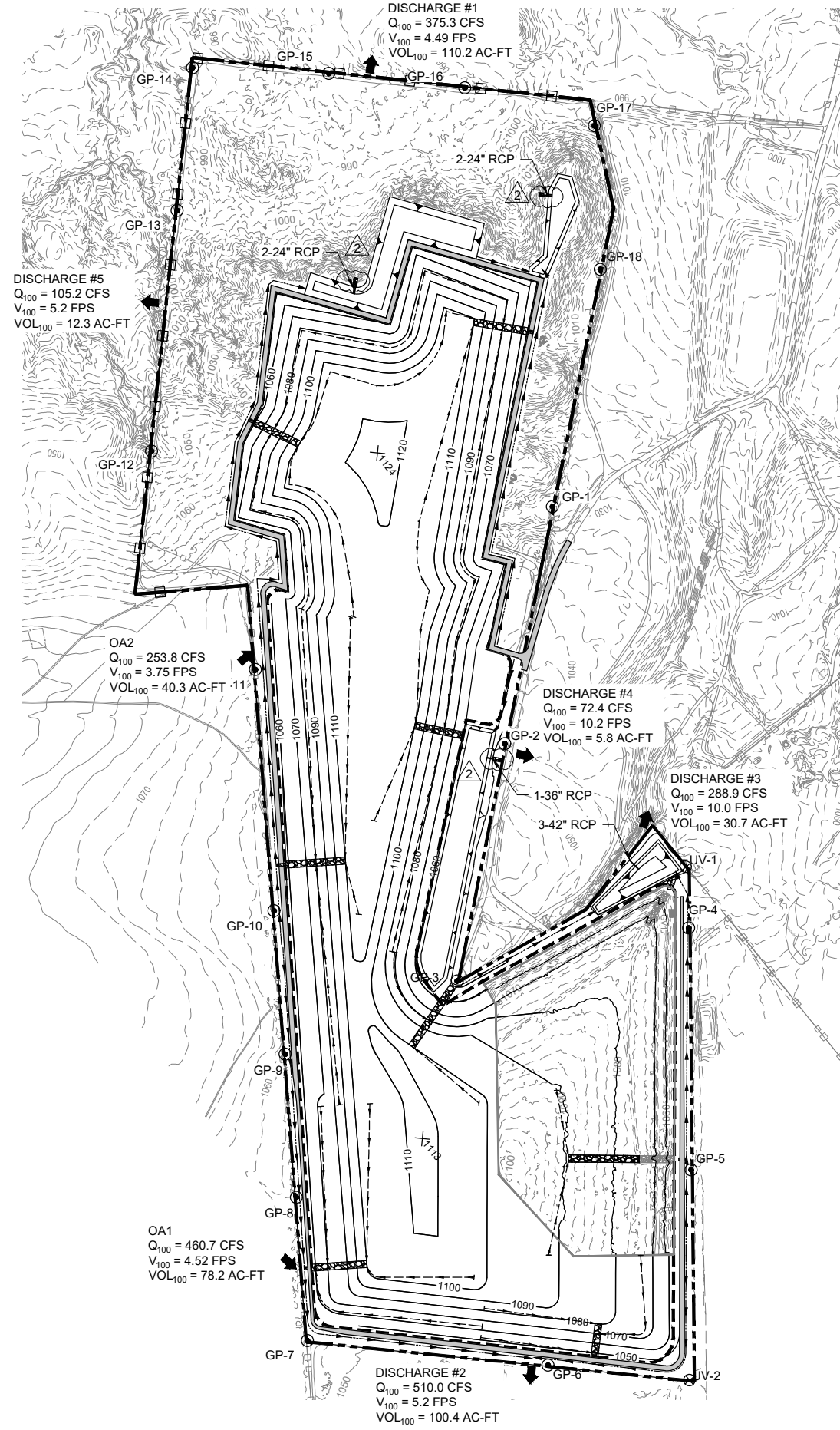
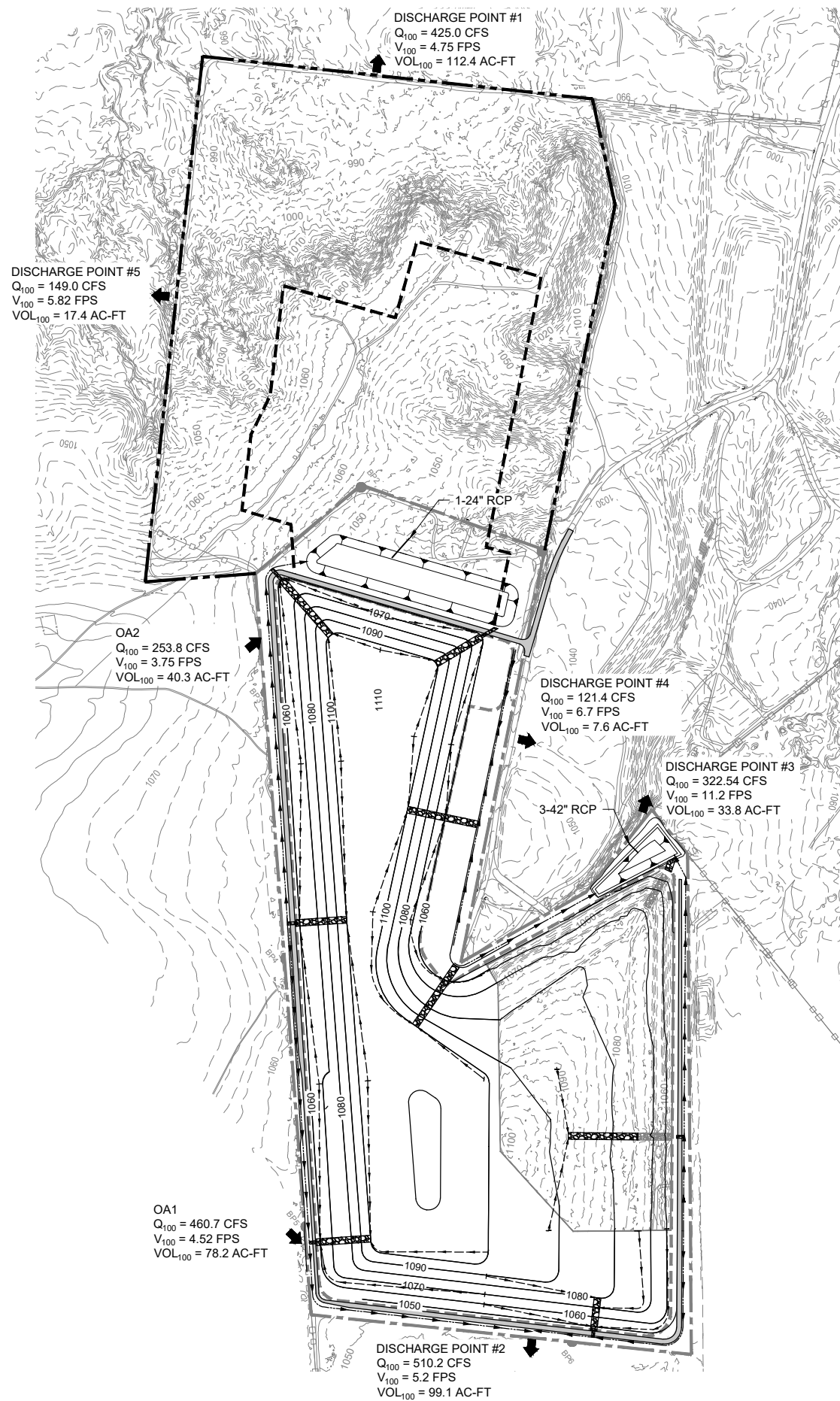

LEGEND

	PERMITTED PERMIT BOUNDARY
	CLOSED CELL BOUNDARY
	PERMITTED LIMIT OF WASTE
	PROPOSED PERMIT BOUNDARY
	PROPOSED LIMIT OF WASTE
	FINAL COVER GRADES
	EXISTING GRADES
	SWALES
	PERIMETER CHANNEL
	CHUTES
	EXISTING GAS PROBE
	EXISTING SITE FENCE
	PROPOSED SITE FENCE
	PROPOSED ACCESS ROAD
	CUT/FILL MARKERS
	EXISTING CHUTE
	EXISTING GAS VENT
	PROPOSED GAS PROBE
	PROPOSED GAS VENTS

CP&Y
an STV Company

TEXAS REGISTERED ENGINEERING FIRM
TBPE F-1741

DEL RIO
TEXAS

NO.	REVISION	BY	DATE
2	2ND TECHNICAL NOD	STV	03/2025
1	1ST TECHNICAL NOD	STV	08/2024

VERIFY SCALE: BAR LENGTH EQUALS ONE INCH ON ORIGINAL DRAWING. VERIFY LENGTH ON THIS SHEET AND ADJUST SCALE ACCORDINGLY.

CITY OF DEL RIO LANDFILL NO. 207C
MAJOR PERMIT AMENDMENT

SITE DRAINAGE PATTERNS
RUNON/RUNOFF

DESIGN: T. METAFERIA
DRAWN: T. METAFERIA
REVIEW: B. HINDMAN
CP&Y: DEL200302
CLIENT: CITY OF DEL RIO

FIGURE III.H.1

FOR PERMITTING PURPOSES ONLY

PRINTED BY: Metaferia
 FILE PATH: C:\working\stvw\stvw\metaferia\0942276\DEL2000302\Figure IIIH.2.dwg

LEGEND	
	PERMIT BOUNDARY
	CLOSED CELL BOUNDARY
	LIMIT OF WASTE
	FINAL COVER CONTOURS
	EXISTING CONTOURS
	PERIMETER CHANNEL
	SWALES
	EXISTING SITE FENCE
	PROPOSED SITE FENCE
	EXISTING CHUTE
	CHUTES
	PROPOSED GAS PROBE
	PROPOSED GAS VENTS

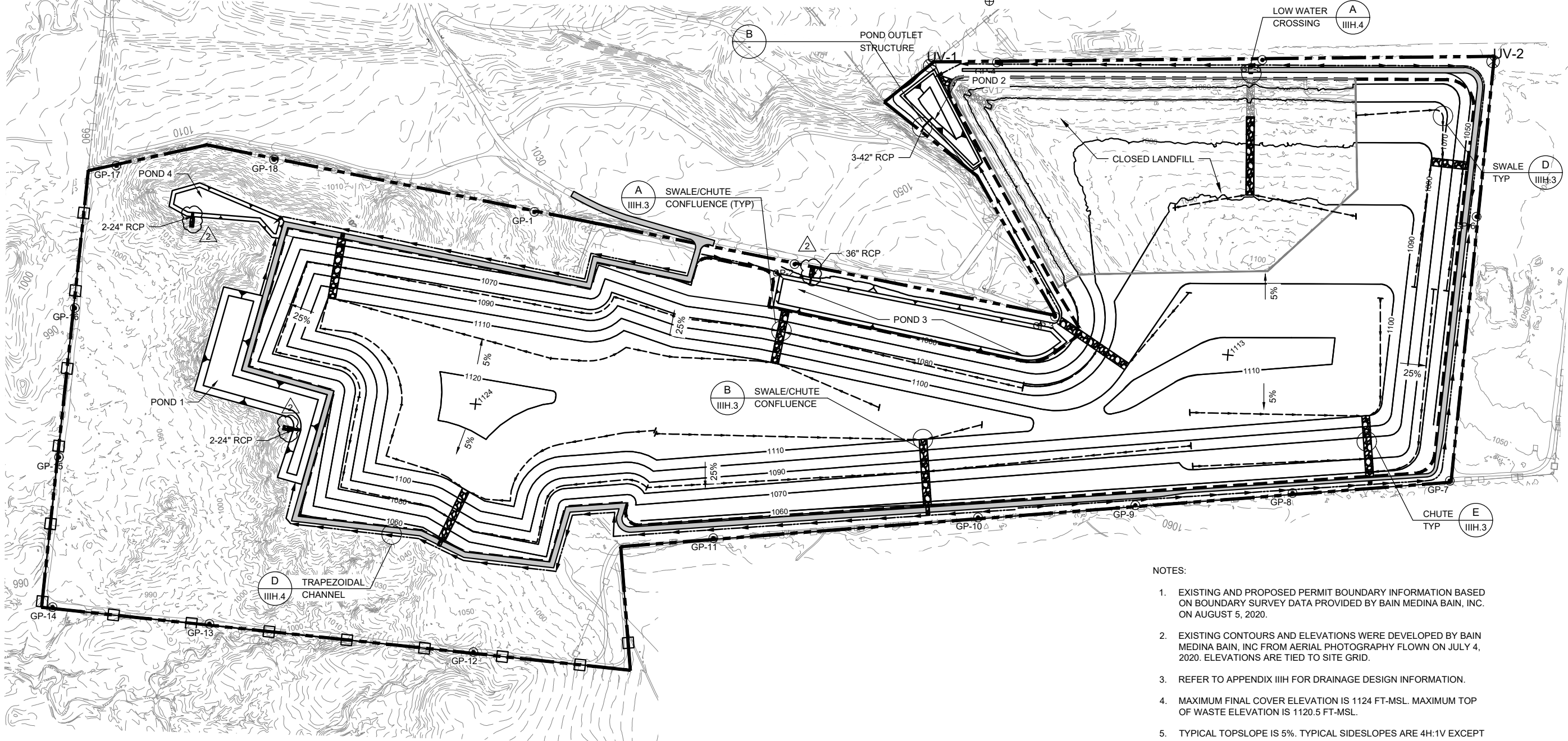
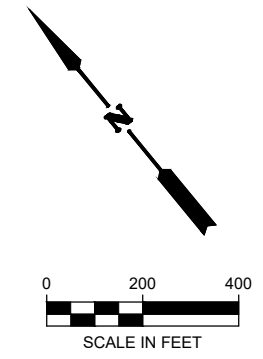

- NOTES:
- EXISTING AND PROPOSED PERMIT BOUNDARY INFORMATION BASED ON BOUNDARY SURVEY DATA PROVIDED BY BAIN MEDINA BAIN, INC. ON AUGUST 5, 2020.
 - EXISTING CONTOURS AND ELEVATIONS WERE DEVELOPED BY BAIN MEDINA BAIN, INC FROM AERIAL PHOTOGRAPHY FLOWN ON JULY 4, 2020. ELEVATIONS ARE TIED TO SITE GRID.
 - REFER TO APPENDIX IIIH FOR DRAINAGE DESIGN INFORMATION.
 - MAXIMUM FINAL COVER ELEVATION IS 1124 FT-MSL. MAXIMUM TOP OF WASTE ELEVATION IS 1120.5 FT-MSL.
 - TYPICAL TOPSLOPE IS 5%. TYPICAL SIDESLOPES ARE 4H:1V EXCEPT IN THE AREA OF THE CLOSED PORTION OF THE LANDFILL IN WHICH THE SIDESLOPES ARE 5H:1V.



NO.	REVISION	DATE
2.	2ND TECHNICAL NOD	03/2025
1.	1ST TECHNICAL NOD	08/2024

VERIFY SCALE BAR LENGTH EQUALS ONE INCH ON ORIGINAL DRAWING. VERIFY LENGTH ON THIS SHEET 0" AND ADJUST SCALE ACCORDINGLY.

CITY OF DEL RIO LANDFILL NO. 207C
 MAJOR PERMIT AMENDMENT

DRAINAGE STRUCTURE PLAN

DESIGN: T. METAFERIA
 DRAWN: T. METAFERIA
 REVIEW: B. HINDMAN
 CP&Y: DELR200302
 CLIENT: CITY OF DEL RIO

FIGURE
 IIIH.2

FOR PERMITTING PURPOSES ONLY

Appendix IIIH-A. Permitted Condition Hydrologic Calculations



TABLE OF CONTENTS

Hypothetical Storm Data	IIIH-A-1
Precipitation Loss Data	IIIH-A-3
Hydrograph Development Information	IIIH-A-12
HEC-1 Output — Permitted-Development 100-Year, 24-Hour Storm Event	IIIH-A-22
HEC-1 Output — Permitted-Development 25-Year, 24-Hour Storm Event	IIIH-A-72
Volume Calculations	IIIH-A-122
Velocity Calculations	IIIH-A-127

LIST OF FIGURES

Web Soil Survey	IIIH-A-5
Off Site Drainage Areas	IIIH-A-15
Permitted Condition Drainage Areas	IIIH-A-16



Appendix IIIH-B. Post-Development Conditions Hydrologic Calculations



TABLE OF CONTENTS

Hydrograph Development Information	IIIH-B-1
HEC-1 Output — Post-Development 100-Year, 24-Hour Storm Event	IIIH-B-10
HEC-1 Output — Post-Development 25-Year, 24-Hour Storm Event	IIIH-B-63
Volume Calculations	IIIH-B-115
Velocity Calculations	IIIH-B-120

LIST OF FIGURES

Post-Development Condition Drainage Areas	IIIH-B-4
---	--------------------------



PRINTED BY: Metaferia
 FILE PATH: C:\working\stvw_s\w\metaferia\0942276\DEL2000302\Figure IIIH-D-8.dwg

LEGEND

- LD2 DRAINAGE AREA DESIGNATION
- DRAINAGE BOUNDARY
- PERIMETER CHANNEL
- GP-5 PROPOSED GAS PROBE
- ⊕ UV-1 PROPOSED GAS VENTS
- PERMIT BOUNDARY
- CLOSED CELL BOUNDARY
- LIMIT OF WASTE
- 1090 FINAL COVER CONTOURS
- 1060 EXISTING CONTOURS
- SWALES
- EXISTING SITE FENCE
- PROPOSED SITE FENCE
- ▨ EXISTING CHUTE
- ▨ CHUTES

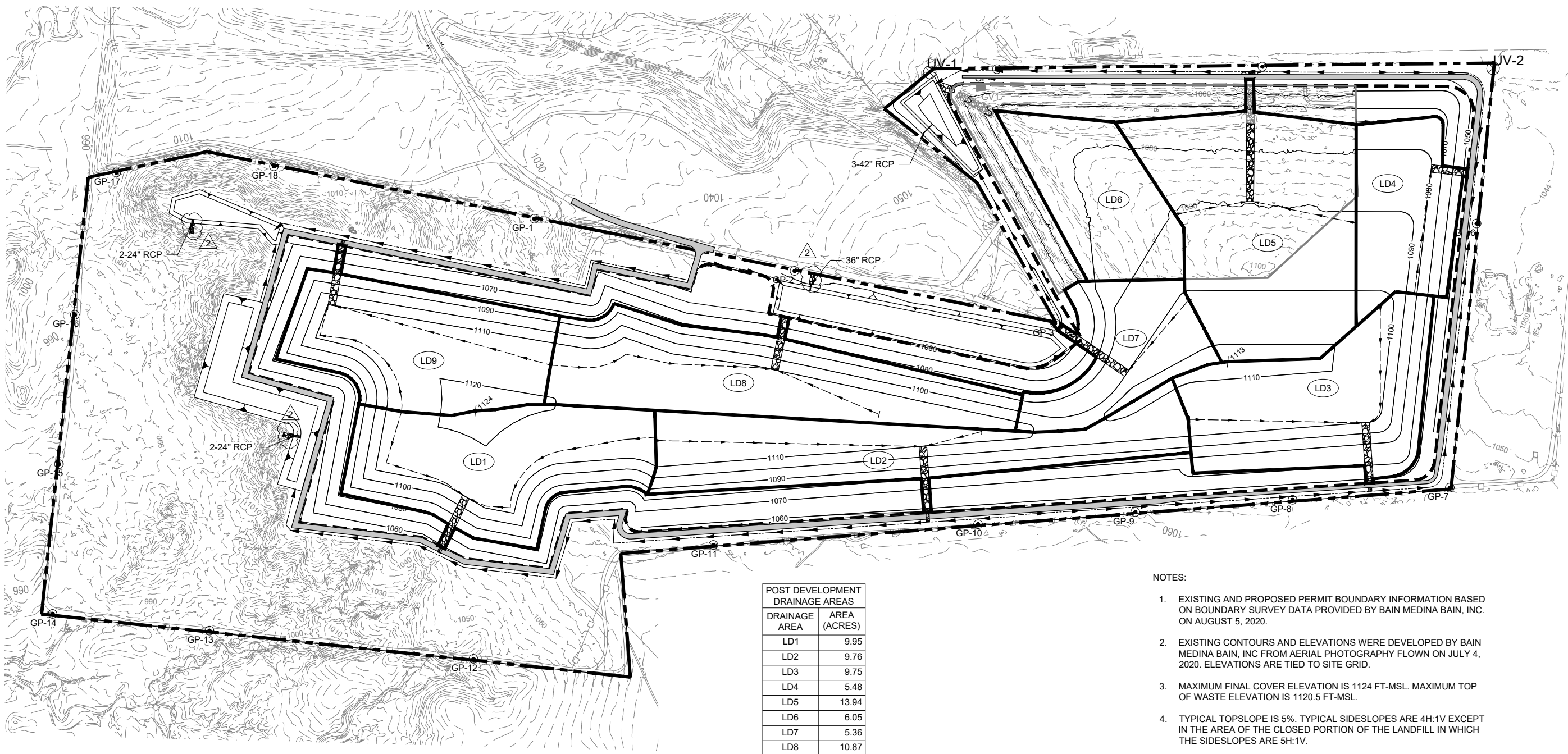
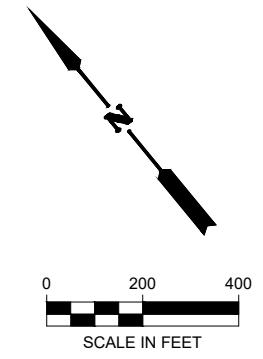

POST DEVELOPMENT DRAINAGE AREAS	
DRAINAGE AREA	AREA (ACRES)
LD1	9.95
LD2	9.76
LD3	9.75
LD4	5.48
LD5	13.94
LD6	6.05
LD7	5.36
LD8	10.87
LD9	9.11

- NOTES:
- EXISTING AND PROPOSED PERMIT BOUNDARY INFORMATION BASED ON BOUNDARY SURVEY DATA PROVIDED BY BAIN MEDINA BAIN, INC. ON AUGUST 5, 2020.
 - EXISTING CONTOURS AND ELEVATIONS WERE DEVELOPED BY BAIN MEDINA BAIN, INC FROM AERIAL PHOTOGRAPHY FLOWN ON JULY 4, 2020. ELEVATIONS ARE TIED TO SITE GRID.
 - MAXIMUM FINAL COVER ELEVATION IS 1124 FT-MSL. MAXIMUM TOP OF WASTE ELEVATION IS 1120.5 FT-MSL.
 - TYPICAL TOPSLOPE IS 5%. TYPICAL SIDESLOPES ARE 4H:1V EXCEPT IN THE AREA OF THE CLOSED PORTION OF THE LANDFILL IN WHICH THE SIDESLOPES ARE 5H:1V.



NO.	REVISION	DATE
2	2ND TECHNICAL NOD	03/2025
1	1ST TECHNICAL NOD	08/2024

VERIFY SCALE BAR LENGTH EQUALS ONE INCH ON ORIGINAL DRAWING. VERIFY LENGTH ON THIS SHEET AND ADJUST SCALE ACCORDINGLY.

CITY OF DEL RIO LANDFILL NO. 207C
 MAJOR PERMIT AMENDMENT

LETDOWN DRAINAGE AREAS

DESIGN: T. METAFERIA
 DRAWN: T. METAFERIA
 REVIEW: B. HINDMAN
 CP&Y: DELR200302
 CLIENT: CITY OF DEL RIO

FIGURE IIIH-D-8

FOR PERMITTING PURPOSES ONLY

Appendix IIIH-C. Channel and Pond Design



LIST OF FIGURES

Perimeter Channel Plan	IIIH-C-4
Channel 1 Profile and Cross Sections	IIIH-C-5
Channel 2 Profile and Cross Sections	IIIH-C-6
Channel 3 Profile and Cross Sections	IIIH-C-7
Channel 4 Profile and Cross Sections	IIIH-C-8
Channel 5 Profile and Cross Sections	IIIH-C-9
Channel 6 Profile and Cross Sections	IIIH-C-10
Channel 7A Profile and Cross Sections	IIIH-C-11
Channel 7B Profile and Cross Section	IIIH-C-11A
Channel 8 Profile and Cross Sections	IIIH-C-12
Pond Plan	IIIH-C-16
Pond 1 Section	IIIH-C-17
Pond 2 Section	IIIH-C-18
Pond 3 Section	IIIH-C-19
Pond 4 Section	IIIH-C-20

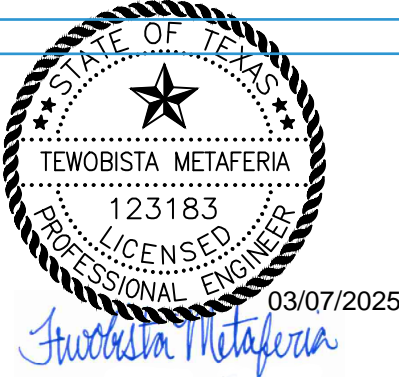

Client: City of Del Rio
 Project: Major Permit Amendment
 Description: Perimeter Channel Design

Date: 8/1/2024
 Job No: DELR2000302
 By: T. Metaferia
 Checked By: B. Hindman

Purpose - To design perimeter channels to contain stormwater runoff from the 25-year frequency storm events.

Perimeter channels have been designed to contain stormwater runoff from the 25-year frequency storm events.

Channel	Station		Flow Rate (cfs)	Bottom Slope %	Bottom Width (ft)	Side Slope (ft/ft)		Normal Depth (ft)	Flow Vel. (fps)	Fronde No.	Vel. Head (ft)	Specific Energy (ft)	Flow Area (sq.ft.)	Top width of Flow (ft)
	Right	Left												
CH1	0+00.00	31+29.16	246.2	0.25%	10	3	3	3.16	4.00	0.48	0.25	3.41	61.51	29.98
CH2	0+00.00	7+67.69	323.4	0.65%	10	2	2	3.07	5.76	0.66	0.52	3.87	56.16	23.44
	7+67.69	8+72.43	323.4	1.50%	10	2	2	2.46	8.81	1.14	1.20	3.37	36.73	19.84
	8+72.43	9+35.38	323.4	1.30%	10	2	2	2.56	8.37	1.07	1.09	3.65	38.66	20.23
	9+35.38	11+53.65	323.4	0.85%	10	2	2	2.86	7.19	0.87	0.80	3.66	45.01	21.45
	11+53.65	24.+63.99	87.8	0.46%	10	2	2	1.67	3.95	0.60	0.24	1.91	22.24	16.67
CH3	0+00.00	10+66.16	70.3	0.43%	10	3	3	1.44	3.41	0.57	0.18	1.62	20.59	18.63
CH4	0+00.00	15+71.63	99.4	0.35%	10	3	2	1.87	3.61	0.53	0.20	2.08	27.52	19.37
CH5	0+00.00	6+64.79	84.0	0.50%	6	3	3	1.84	3.96	0.63	0.24	2.08	21.21	17.05
CH6	0+00.00	3+27.78 2+59.26	12.8	1.00%	0	3	3	1.14	3.29	0.77	0.17	1.31	3.89	6.84
CH7	0+00.00	15+98.22	123.2	1.00%	10	3	3	1.55	5.43	0.88	0.46	2.01	22.70	19.30
CH7A ⁴	0+00.00	3+55.95	12.2	0.10%	10	3	3	0.82	1.20	0.26	0.02	0.84	10.17	14.90
CH7B	0+00.00	11+34.72	123.2	0.68%	3	3	3	2.41	4.99	0.74	0.39	2.80	24.67	17.47
	0+00.00	12+21.50	123.2	0.20%	3	3	3	3.14	3.16	0.42	0.16	3.29	38.96	21.83
CH8	0+00.00	3+27.78 2+20.77	6.6	1.00%	0	3	3	0.90	2.82	0.74	0.12	1.03	2.45	5.43

Note:

- Calculations were performed using Bentley FlowMaster.
- n = 0.03 (Manning Coefficient) is used for the calculations.
- Flow rates used for the perimeter channel design were taken from the HEC-1 analysis included in Appendix IIIH-B.
- The drainage area for Channel 7A is shown on sheet IIIH-C-4. Q=CIA was used to calculate the flow rate for Channel 7A. The flow rate for 7B is obtained from HEC-1 analysis included in Appendix IIIH-B which includes the Channel 7A area.

Channel Erosion Control Design:

Channel erosion controls have been designed for flow velocities resulted from the 25-year frequency flow rates. As shown on above velocities in the perimeter channels range from

The following was used to select the type of channel lining material.

- Vegetation - used in all areas where velocities are less than 5 ft/s for channels.
- Turf reinforcement matting - used in channels for velocities between 5 ft/s and 13 ft/s.

LEGEND

	PERIMETER CHANNEL		PERMIT BOUNDARY
	PROPOSED GAS PROBE		CLOSED CELL BOUNDARY
	PROPOSED GAS VENTS		LIMIT OF WASTE
	EXISTING CHUTE		FINAL COVER CONTOURS
	CHUTES		EXISTING CONTOURS
			SWALES
			EXISTING SITE FENCE
			PROPOSED SITE FENCE

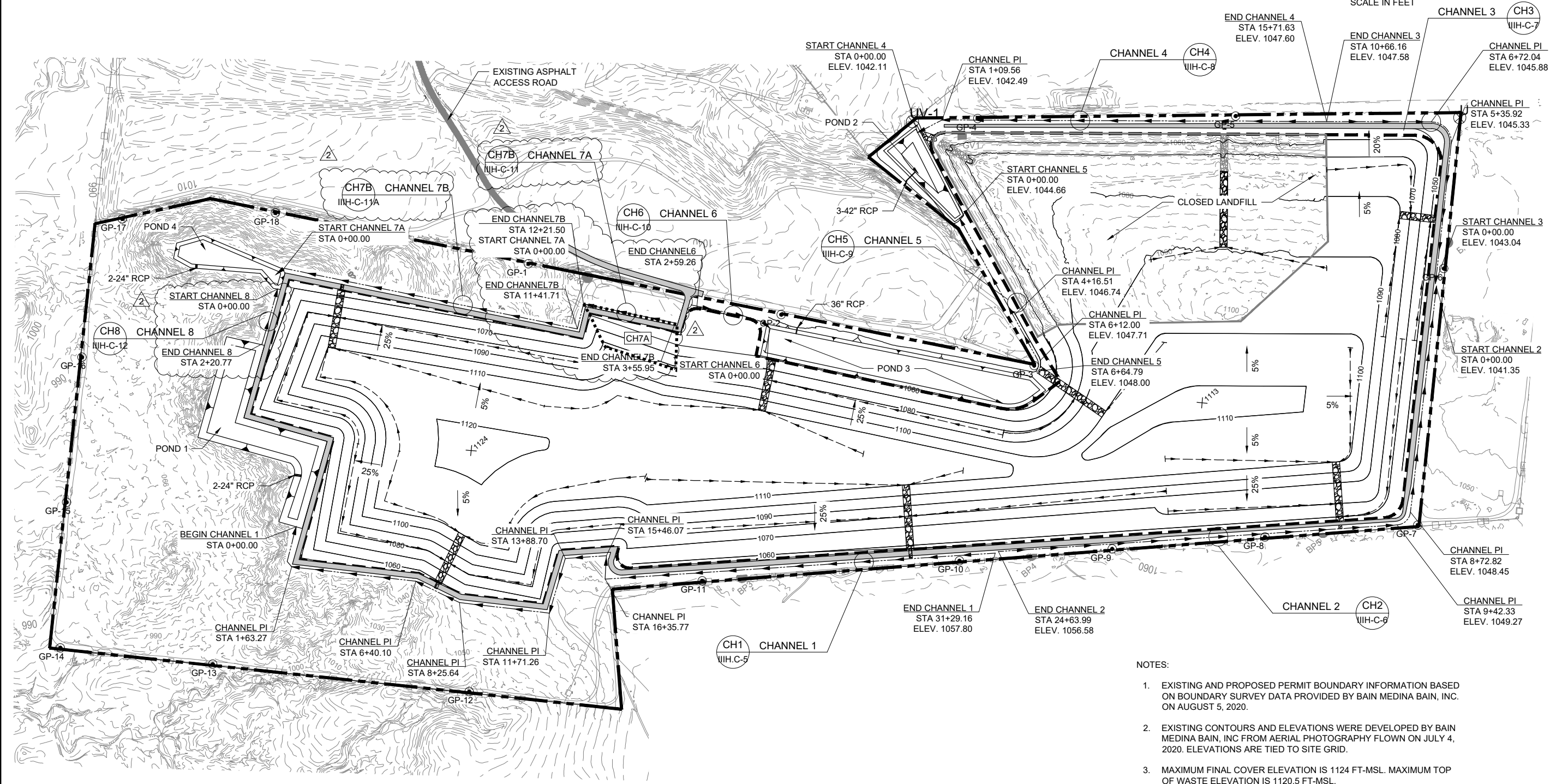
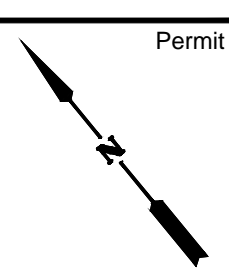

NOTES:

- EXISTING AND PROPOSED PERMIT BOUNDARY INFORMATION BASED ON BOUNDARY SURVEY DATA PROVIDED BY BAIN MEDINA BAIN, INC. ON AUGUST 5, 2020.
- EXISTING CONTOURS AND ELEVATIONS WERE DEVELOPED BY BAIN MEDINA BAIN, INC FROM AERIAL PHOTOGRAPHY FLOWN ON JULY 4, 2020. ELEVATIONS ARE TIED TO SITE GRID.
- MAXIMUM FINAL COVER ELEVATION IS 1124 FT-MSL. MAXIMUM TOP OF WASTE ELEVATION IS 1120.5 FT-MSL.
- TYPICAL TOPSLOPE IS 5%. TYPICAL SIDESLOPES ARE 4H:1V EXCEPT IN THE AREA OF THE CLOSED PORTION OF THE LANDFILL IN WHICH THE SIDESLOPES ARE 5H:1V.



NO.	REVISION	DATE
2.	2nd TECHNICAL NOD	03/2025
1.	1ST TECHNICAL NOD	08/2024

VERIFY SCALE BAR LENGTH EQUALS ONE INCH ON ORIGINAL DRAWING. VERIFY LENGTH ON THIS SHEET 0' AND ADJUST SCALE ACCORDINGLY.

CITY OF DEL RIO LANDFILL NO. 207C
MAJOR PERMIT AMENDMENT

PERIMETER CHANNEL PLAN

DESIGN: T. METAFERIA
DRAWN: T. METAFERIA
REVIEW: B. HINDMAN
CP&Y: DELR200302
CLIENT: CITY OF DEL RIO



PRINTED BY: Metaferia T DATE: 11/22/2024
FILE PATH: C:\working\svw\svw\time\del_r\0942276\DELRLR200302\Figure IIIH-C-4.dwg

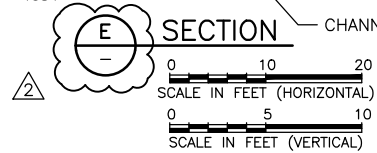
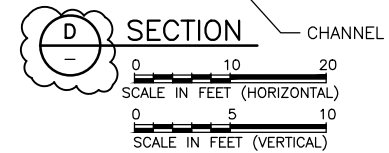
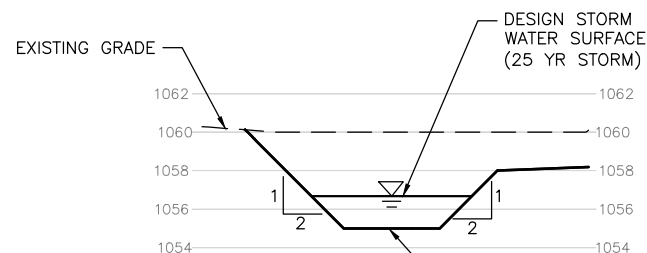
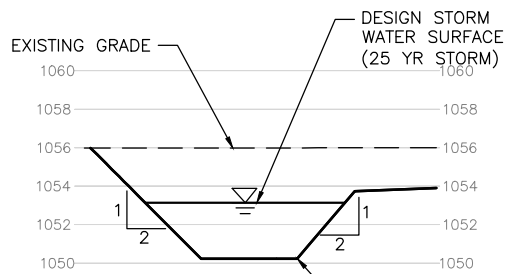
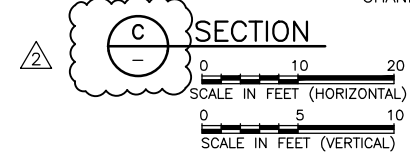
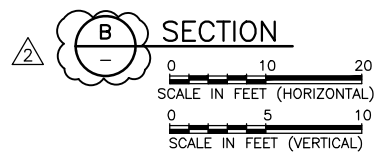
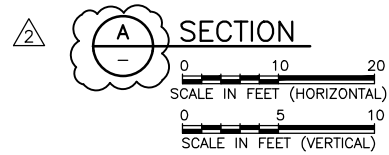
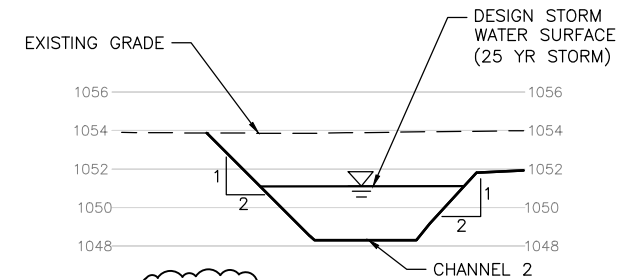
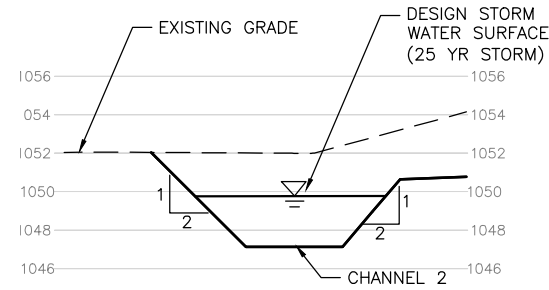
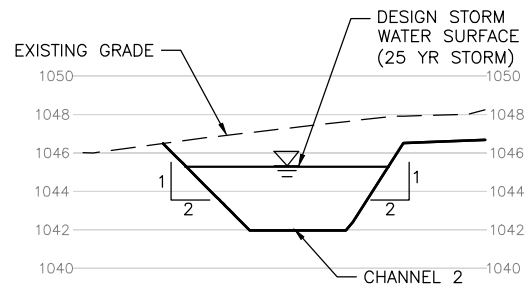
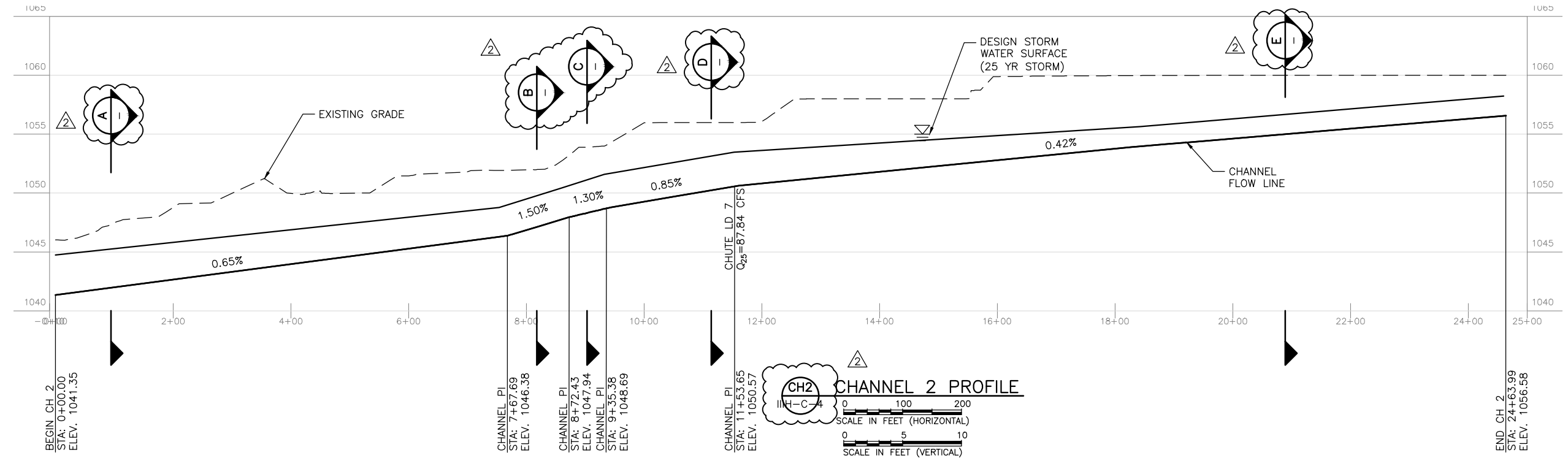

Channel	Station	Bottom Width (ft)	Flow Rate (cfs)	Bottom Slope %	Flow Vel. (fps)	Normal Depth (ft)
0+00.00	7+67.69	10	323.4	0.65%	5.76	3.36
7+67.69	8+72.43	10	323.4	1.50%	8.81	2.46
8+72.43	9+35.38	10	323.4	1.30%	8.37	2.56
9+35.38	11+53.65	10	323.4	0.85%	7.19	2.86
11+53.65	24+63.99	10	87.8	0.46%	3.95	1.67

THE FOLLOWING WAS USED TO SELECT THE TYPE OF CHANNEL LINING MATERIAL

- VEGETATION WILL BE USED IN ALL AREAS WHERE VELOCITIES ARE LESS THAN 5 FT/S.
- TURF REINFORCEMENT MATTING WILL BE USED IN CHANNEL SECTIONS THAT HAVE VELOCITIES BETWEEN 5 FT/S AND 13 FT/S.



NO.	REVISION	BY	DATE
2.	2ND TECHNICAL NOD	STV	03/2025
1.	1ST TECHNICAL NOD	STV	08/2024

VERIFY SCALE BAR LENGTH EQUALS ONE INCH ON ORIGINAL DRAWING. VERIFY LENGTH ON THIS SHEET AND ADJUST SCALE ACCORDINGLY.

CITY OF DEL RIO LANDFILL NO. 207C MAJOR PERMIT AMENDMENT

CHANNEL 2 PROFILE AND CROSS SECTIONS

DESIGN: T. METAFERIA
 DRAWN: T. METAFERIA
 REVIEW: B. HINDMAN
 CP&Y: DELR200302
 CLIENT: CITY OF DEL RIO

FIGURE IIIH-C-6

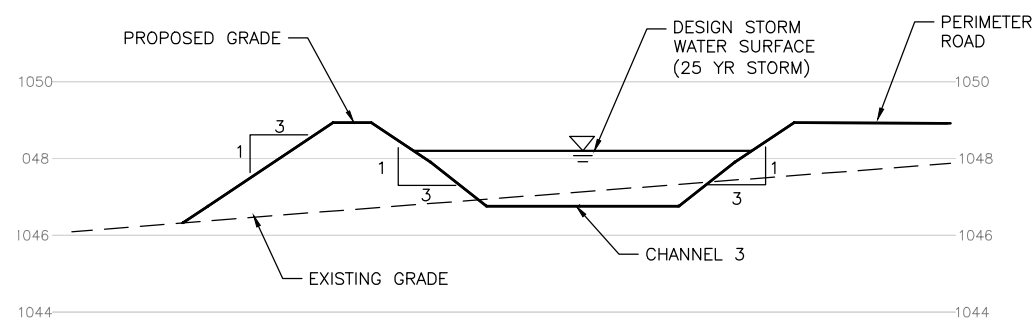
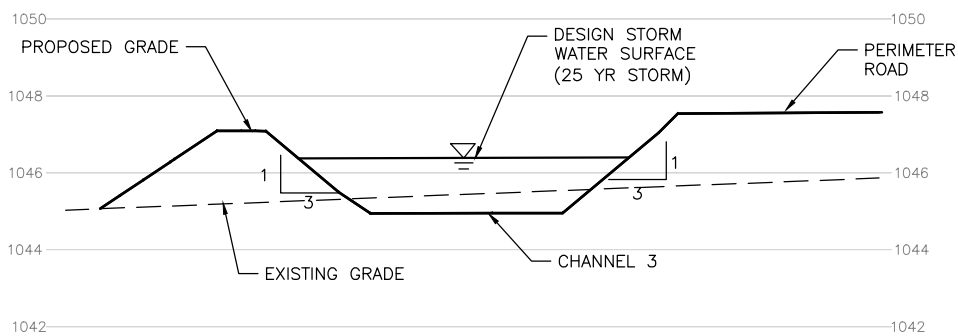
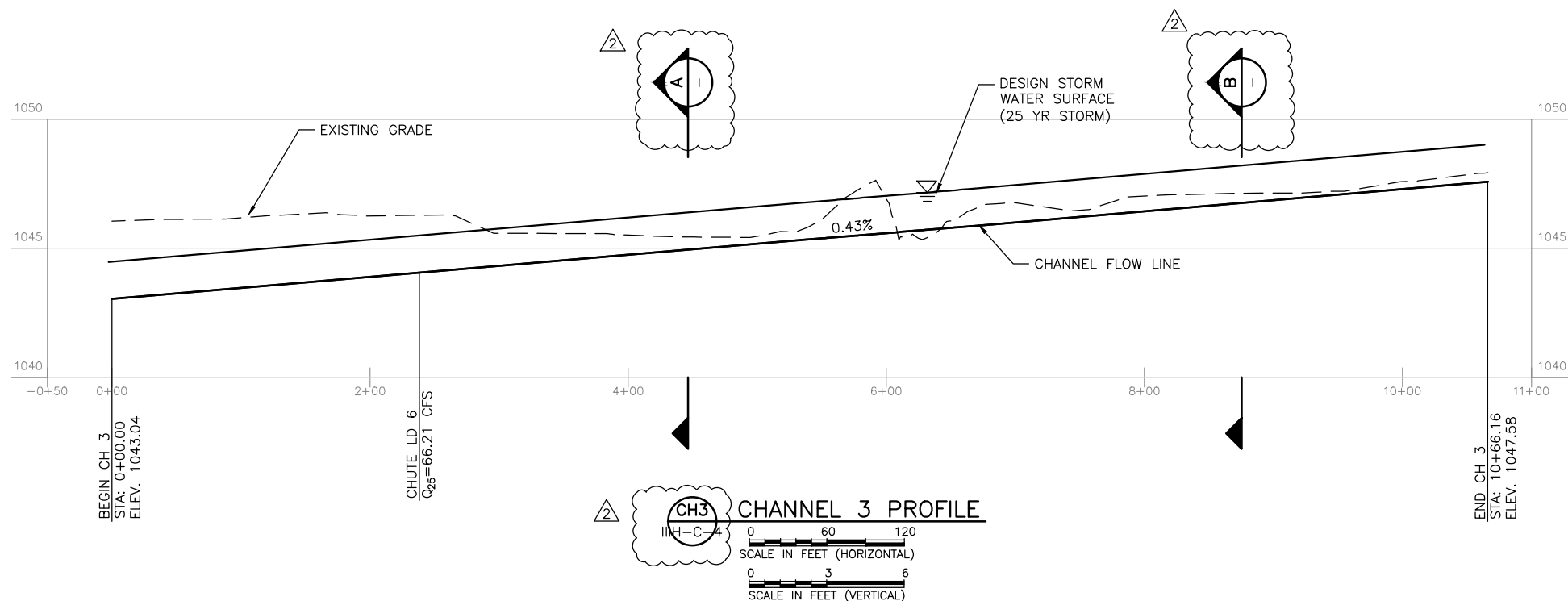

Channel Station	Bottom Width (ft)	Peak Flow (cfs)	Slope (%)	Velocity (ft/s)	Flow Depth (ft)
From 0+00.00 To 10+66.16	10	70.3	0.43	3.41	1.44

THE FOLLOWING WAS USED TO SELECT THE TYPE OF CHANNEL LINING MATERIAL

- VEGETATION WILL BE USED IN ALL AREAS WHERE VELOCITIES ARE LESS THAN 5 FT/S.
- TURF REINFORCEMENT MATTING WILL BE USED IN CHANNEL SECTIONS THAT HAVE VELOCITIES BETWEEN 5 FT/S AND 13 FT/S.



NO.	REVISION	BY	DATE
2	2ND TECHNICAL NOD	STV	03/2025
1	1ST TECHNICAL NOD	STV	08/2024

VERIFY SCALE BAR LENGTH EQUALS ONE INCH ON ORIGINAL DRAWING. VERIFY LENGTH ON THIS SHEET AND ADJUST SCALE ACCORDINGLY.

CITY OF DEL RIO LANDFILL NO. 207C
MAJOR PERMIT AMENDMENT

CHANNEL 3 PROFILE AND CROSS-SECTIONS

DESIGN: T. METAFERIA
DRAWN: T. METAFERIA
REVIEW: B. HINDMAN
CP&Y: DELR200302
CLIENT: CITY OF DEL RIO

FIGURE
IIH-C-7

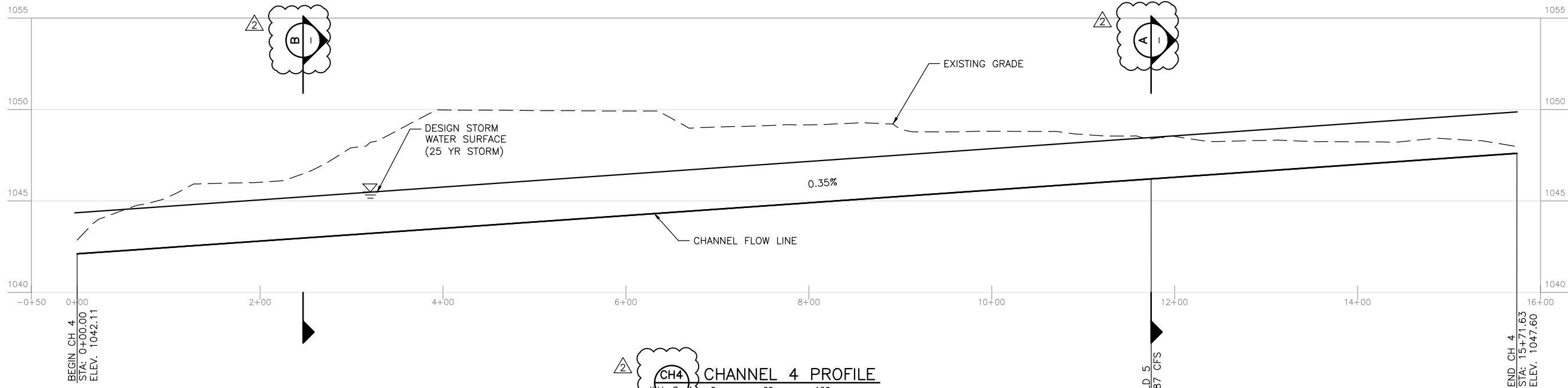

CHANNEL 4 PROFILE
 IIIH-C-4
 SCALE IN FEET (HORIZONTAL)
 0 60 120
 SCALE IN FEET (VERTICAL)
 0 3 6

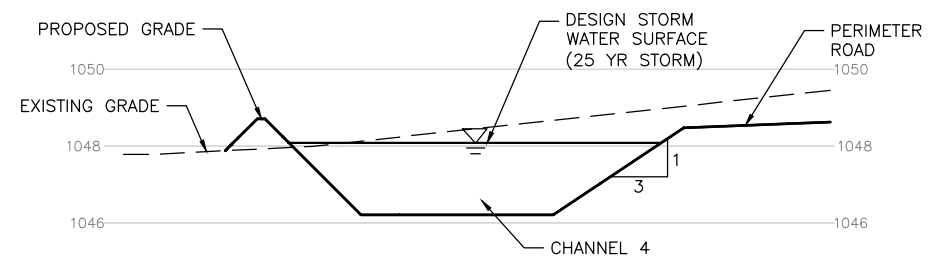

SECTION A
 SCALE IN FEET (HORIZONTAL)
 0 5 10
 SCALE IN FEET (VERTICAL)
 0 2.5 5

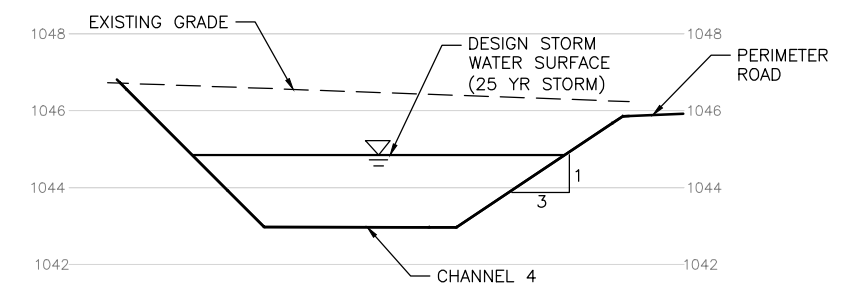

SECTION B
 SCALE IN FEET (HORIZONTAL)
 0 5 10
 SCALE IN FEET (VERTICAL)
 0 2.5 5

Channel	Station	Bottom Width (ft)	Flow Rate (cfs)	Bottom Slope %	Flow Vel. (fps)	Normal Depth (ft)
0+00.00	15+71.63	10	99.4	0.35%	3.61	1.87

THE FOLLOWING WAS USED TO SELECT THE TYPE OF CHANNEL LINING MATERIAL

- VEGETATION WILL BE USED IN ALL AREAS WHERE VELOCITIES ARE LESS THAN 5 FT/S.
- TURF REINFORCEMENT MATTING WILL BE USED IN CHANNEL SECTIONS THAT HAVE VELOCITIES BETWEEN 5 FT/S AND 13 FT/S.



NO.	REVISION	BY	DATE
2.	2nd TECHNICAL NOD	STV	03/2025
1.	1ST TECHNICAL NOD	STV	08/2024

VERIFY SCALE BAR LENGTH EQUALS ONE INCH ON ORIGINAL DRAWING. VERIFY LENGTH ON THIS SHEET AND ADJUST SCALE ACCORDINGLY.

CITY OF DEL RIO LADELL NO. 207C
 MAJOR PERMIT AMENDMENT

CHANNEL 4 PROFILE AND
 CROSS SECTION

DESIGN: T. METAFERIA
 DRAWN: T. METAFERIA
 REVIEW: B. HINDMAN
 CP&Y: DELR200302
 CLIENT: CITY OF DEL RIO

FIGURE
 IIIH-C-8

PRINTED BY: Metaferia T
 FILE PATH: C:\pwworking\kingst\pwworking\st\metafert\delr\0942276\DELRLR200302\Figure IIIH-C-8.dwg

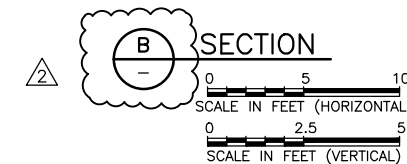
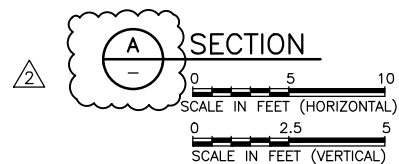
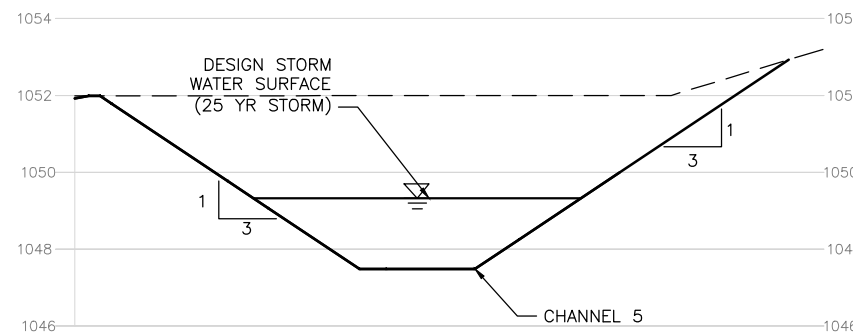
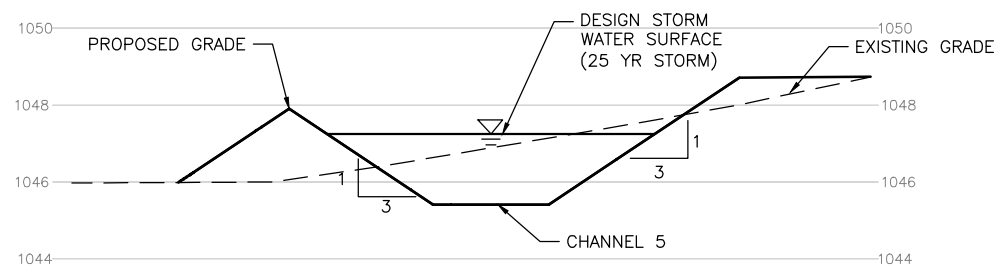
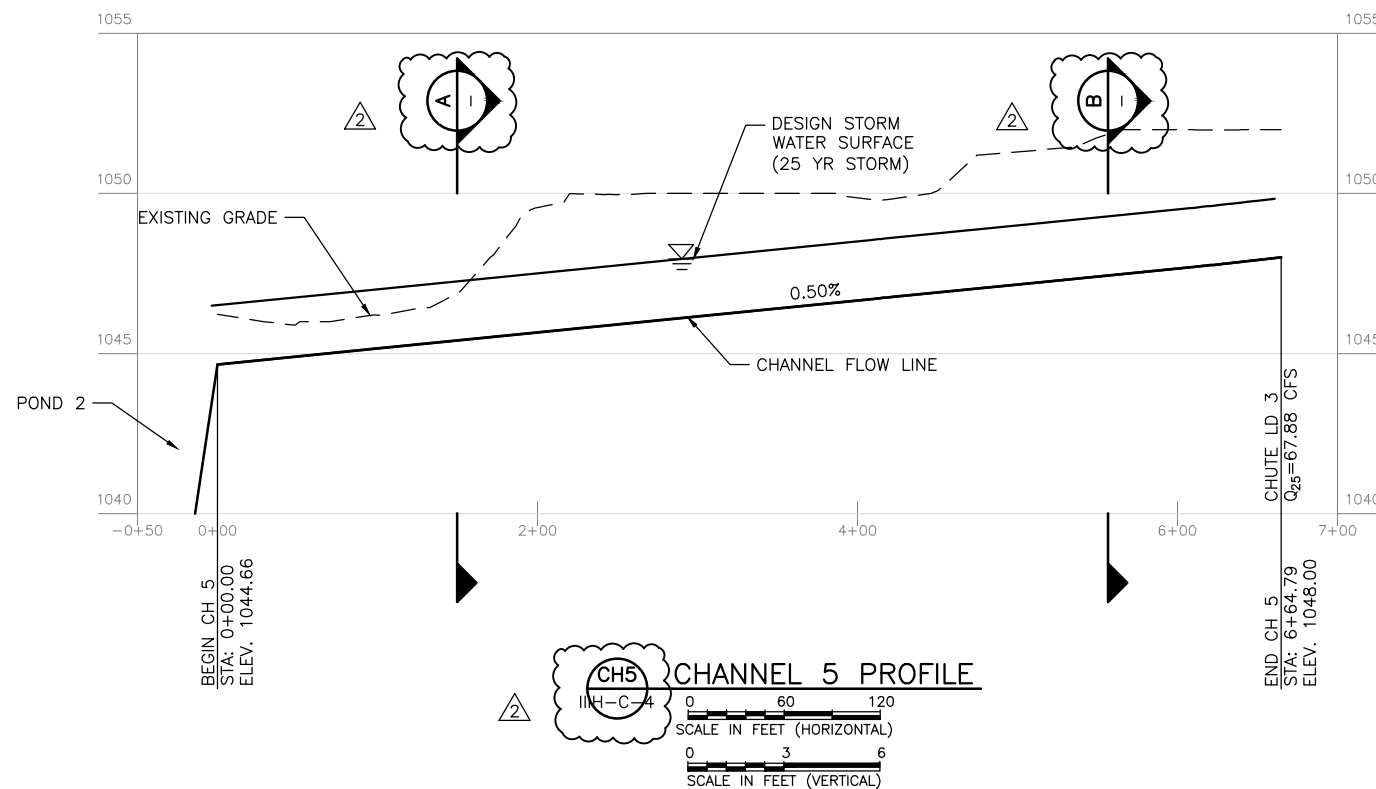

Channel Station	Bottom Width (ft)	Peak Flow (cfs)	Slope (%)	Velocity (ft/s)	Flow Depth (ft)
From 0+00.00 To 6+64.79	6	84	0.5	3.96	1.84

THE FOLLOWING WAS USED TO SELECT THE TYPE OF CHANNEL LINING MATERIAL

- VEGETATION WILL BE USED IN ALL AREAS WHERE VELOCITIES ARE LESS THAN 5 FT/S.
- TURF REINFORCEMENT MATTING WILL BE USED IN CHANNEL SECTIONS THAT HAVE VELOCITIES BETWEEN 5 FT/S AND 13 FT/S.

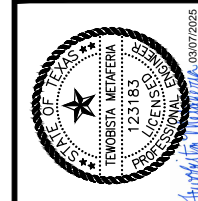

NO.	REVISION	BY	DATE
2.	2ND TECHNICAL NOD	STV	03/2025
1.	1ST TECHNICAL NOD	STV	08/2024

VERIFY SCALE BAR LENGTH EQUALS ONE INCH ON ORIGINAL DRAWING. VERIFY LENGTH ON THIS SHEET AND ADJUST SCALE ACCORDINGLY.

CITY OF DEL RIO LANDFILL NO. 207C MAJOR PERMIT AMENDMENT

CHANNEL 5 PROFILE AND CROSS SECTIONS

DESIGN: T. METAFERIA
 DRAWN: T. METAFERIA
 REVIEW: B. HINDMAN
 CP&Y: DELR200302
 CLIENT: CITY OF DEL RIO

FIGURE IIIH-C-9

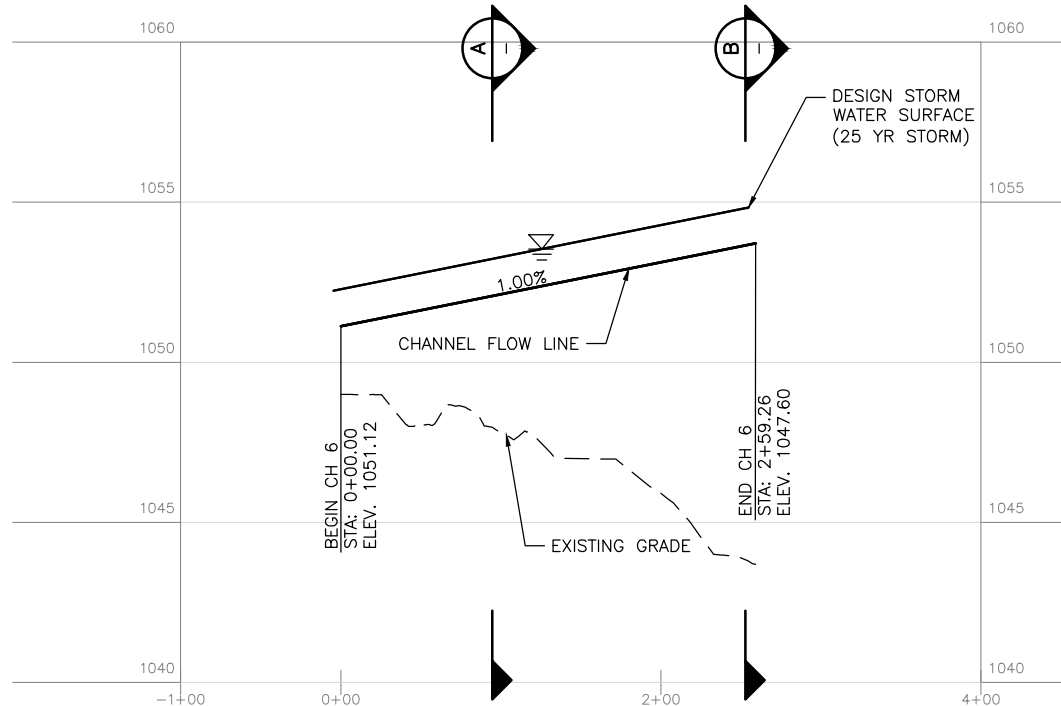

Channel	Station	Flow Rate (cfs)	Bottom Slope %	Bottom Width (ft)	Normal Depth (ft)
CH6	0+00.00 2+59.26	12.8	1.00%	0	1.14

THE FOLLOWING WAS USED TO SELECT THE TYPE OF CHANNEL LINING MATERIAL

- VEGETATION WILL BE USED IN ALL AREAS WHERE VELOCITIES ARE LESS THAN 5 FT/S.
- TURF REINFORCEMENT MATTING WILL BE USED IN CHANNEL SECTIONS THAT HAVE VELOCITIES BETWEEN 5 FT/S AND 13 FT/S.

CH6 CHANNEL 6 PROFILE
 IIIH-C-4
 SCALE IN FEET (HORIZONTAL)
 SCALE IN FEET (VERTICAL)

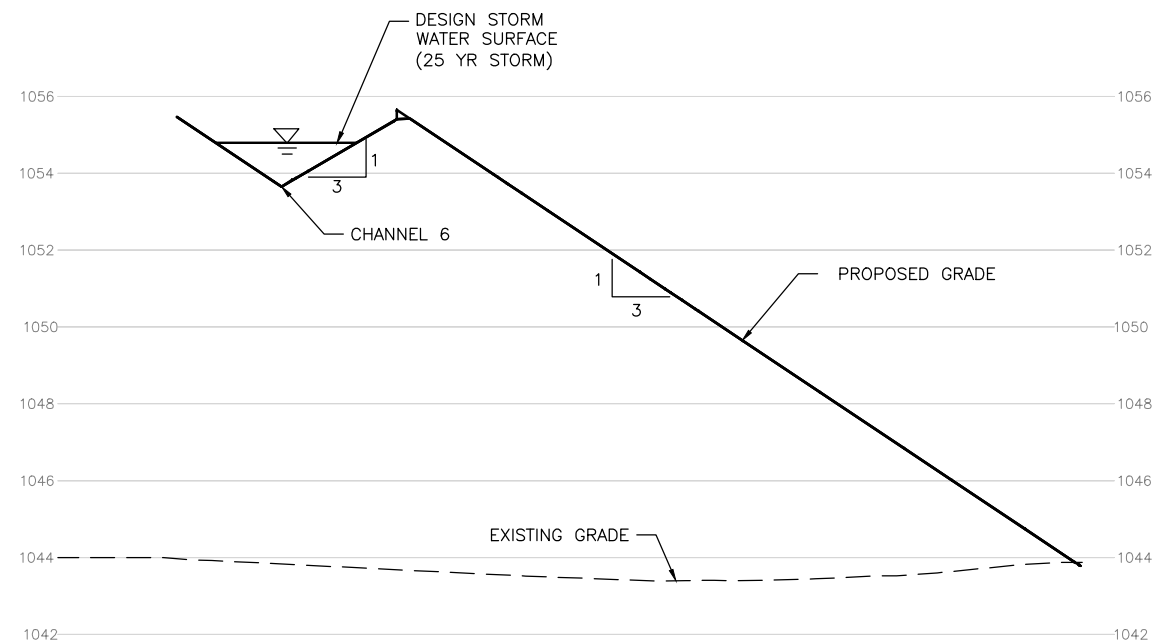

A SECTION
 SCALE IN FEET (HORIZONTAL)
 SCALE IN FEET (VERTICAL)

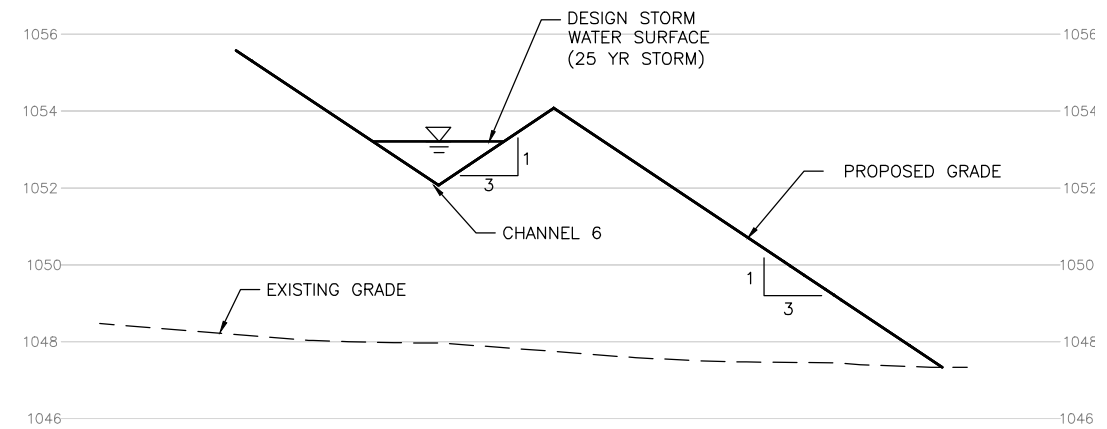

B SECTION
 SCALE IN FEET (HORIZONTAL)
 SCALE IN FEET (VERTICAL)



NO.	REVISION	BY	DATE
1.	2nd TECHNICAL NOD	STV	03/2025

VERIFY SCALE BAR LENGTH EQUALS ONE INCH ON ORIGINAL DRAWING. VERIFY LENGTH ON THIS SHEET AND ADJUST SCALE ACCORDINGLY.

CITY OF DEL RIO LANDFILL NO. 207C
 MAJOR PERMIT AMENDMENT
 CHANNEL 6 PROFILE AND
 CROSS SECTION

DESIGN: T. METAFERIA
 DRAWN: T. METAFERIA
 REVIEW: B. HINDMAN
 CP&Y: DELR200302
 CLIENT: CITY OF DEL RIO

FIGURE
 IIIH-C-10

Channel	Station	Flow Rate (cfs)	Bottom Slope %	Bottom Width (ft)	Normal Depth (ft)	Flow Vel. (fps)
CH7A	0+00.00 3+55.95	12.2	0.10%	10	0.82	1.20

THE FOLLOWING WAS USED TO SELECT THE TYPE OF CHANNEL LINING MATERIAL

- VEGETATION WILL BE USED IN ALL AREAS WHERE VELOCITIES ARE LESS THAN 5 FT/S.
- TURF REINFORCEMENT MATTING WILL BE USED IN CHANNEL SECTIONS THAT HAVE VELOCITIES BETWEEN 5 FT/S AND 13 FT/S.

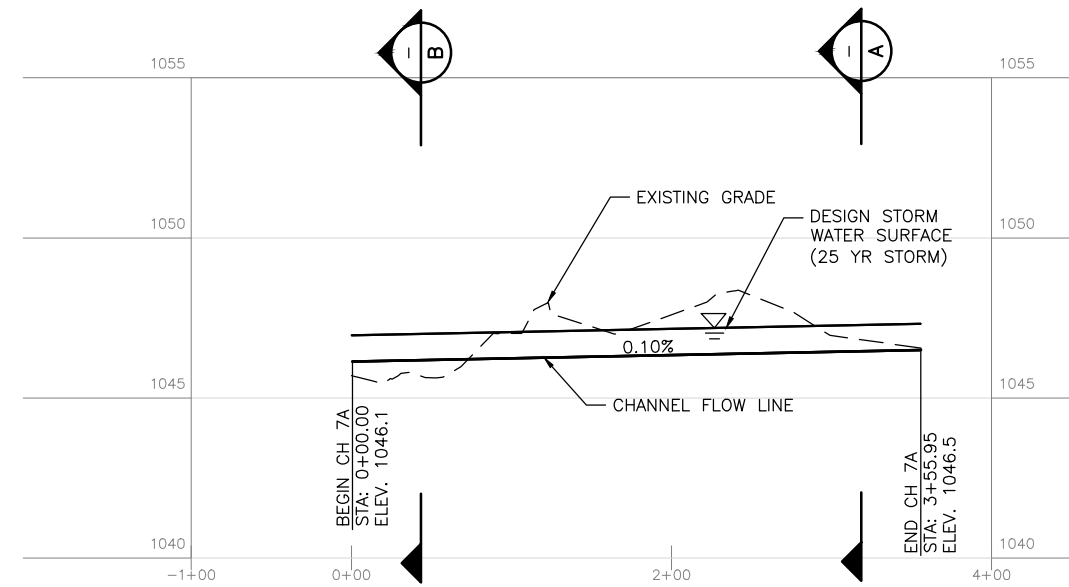

CH7A CHANNEL 7A PROFILE
 IIIH-C-4
 0 60 120
 SCALE IN FEET (HORIZONTAL)
 0 3 6
 SCALE IN FEET (VERTICAL)

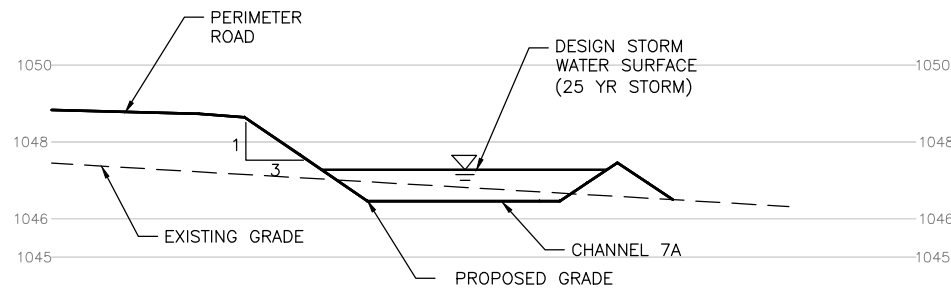

A SECTION
 0 5 10
 SCALE IN FEET (HORIZONTAL)
 0 2.5 5
 SCALE IN FEET (VERTICAL)

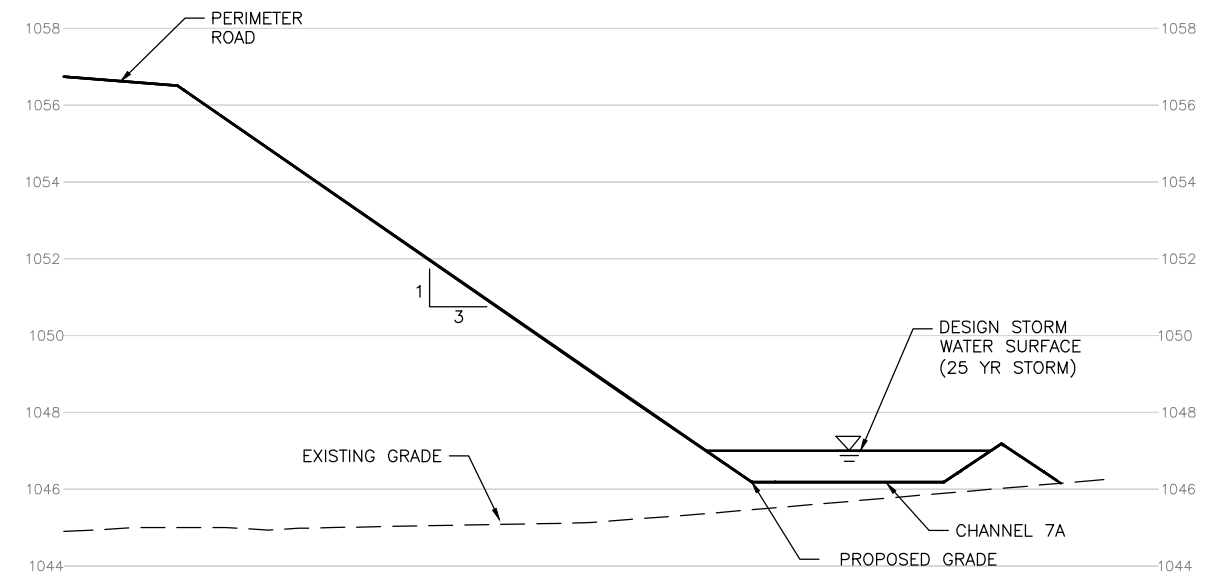

B SECTION
 0 5 10
 SCALE IN FEET (HORIZONTAL)
 0 2.5 5
 SCALE IN FEET (VERTICAL)



NO.	REVISION	BY	DATE
1.	2nd TECHNICAL NOD	STV	03/2025

VERIFY SCALE BAR LENGTH EQUALS ONE INCH ON ORIGINAL DRAWING. VERIFY LENGTH ON THIS SHEET AND ADJUST SCALE ACCORDINGLY.

CITY OF DEL RIO LANDFILL NO. 207C MAJOR PERMIT AMENDMENT

CHANNEL 7A PROFILE AND CROSS SECTION

DESIGN: T. METAFERIA
 DRAWN: T. METAFERIA
 REVIEW: B. HINDMAN
 CP&Y: DELR200302
 CLIENT: CITY OF DEL RIO

FIGURE IIIH-C-11

FOR PERMITTING PURPOSES ONLY

PRINTED BY: Metaferia T
 FILE PATH: C:\pwworking\kingstvw\st\time\afarid\0942276\DEL200302\Figure IIIH-C-11.dwg

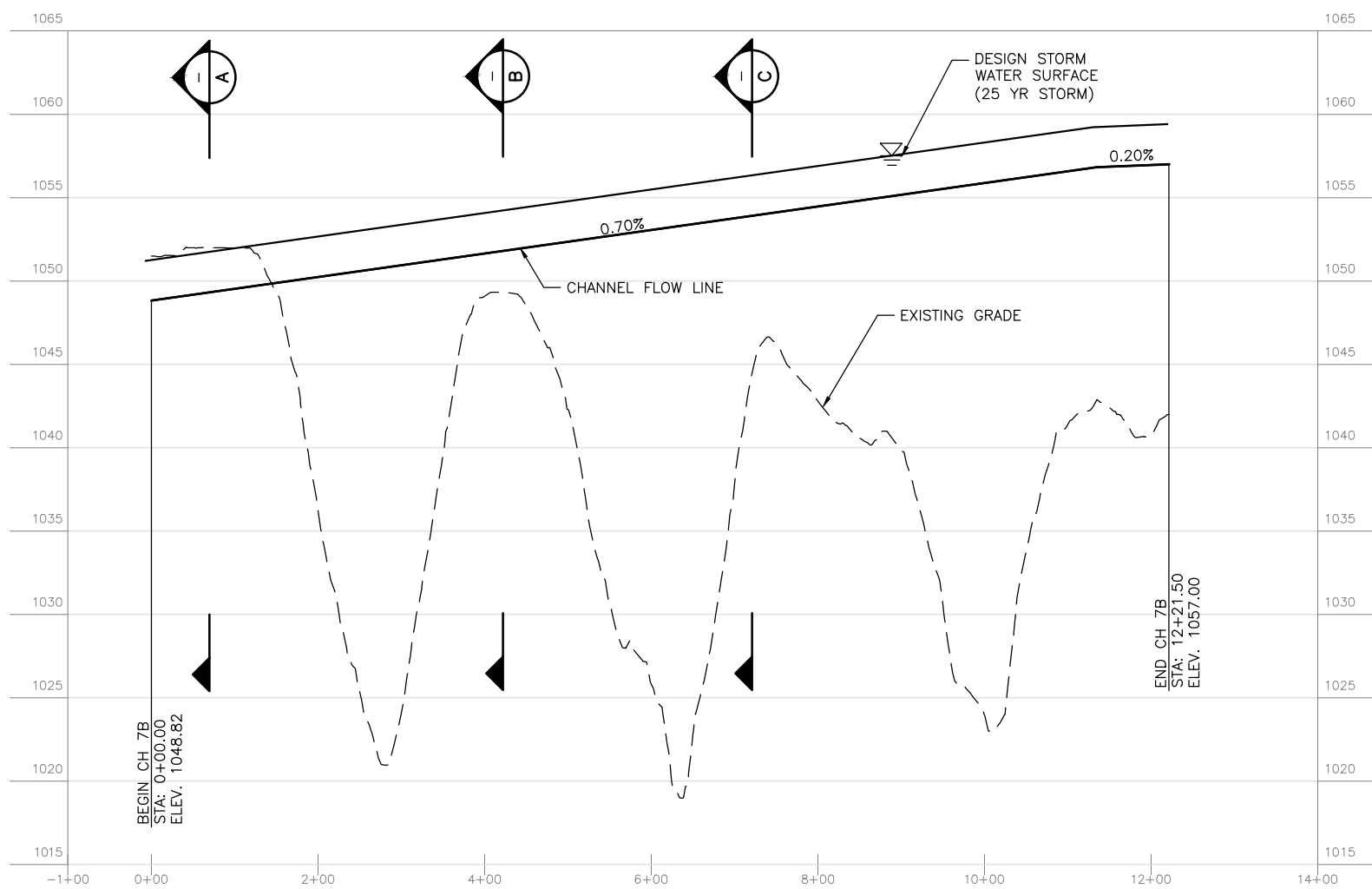

CH7B CHANNEL 7B PROFILE
 IIIH-C-11A
 SCALE IN FEET (HORIZONTAL): 0, 100, 200
 SCALE IN FEET (VERTICAL): 0, 5, 10

Channel	Station	Flow Rate (cfs)	Bottom Slope %	Bottom Width (ft)	Normal Depth (ft)	Flow Vel. (fps)
CH7B	0+00.00	11+34.72	123.2	0.68%	3	2.41
	0+00.00	12+21.50	123.2	0.20%	3	3.14

THE FOLLOWING WAS USED TO SELECT THE TYPE OF CHANNEL LINING MATERIAL
 - VEGETATION WILL BE USED IN ALL AREAS WHERE VELOCITIES ARE LESS THAN 5 FT/S.
 - TURF REINFORCEMENT MATTING WILL BE USED IN CHANNEL SECTIONS THAT HAVE VELOCITIES BETWEEN 5 FT/S AND 13 FT/S.

C SECTION
 SCALE IN FEET (HORIZONTAL): 0, 5, 10
 SCALE IN FEET (VERTICAL): 0, 2.5, 5

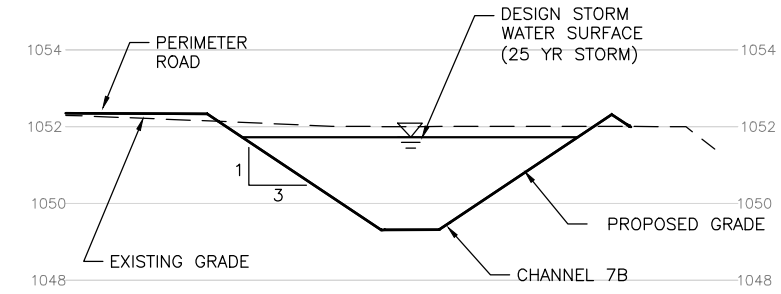

A SECTION
 SCALE IN FEET (HORIZONTAL): 0, 5, 10
 SCALE IN FEET (VERTICAL): 0, 2.5, 5

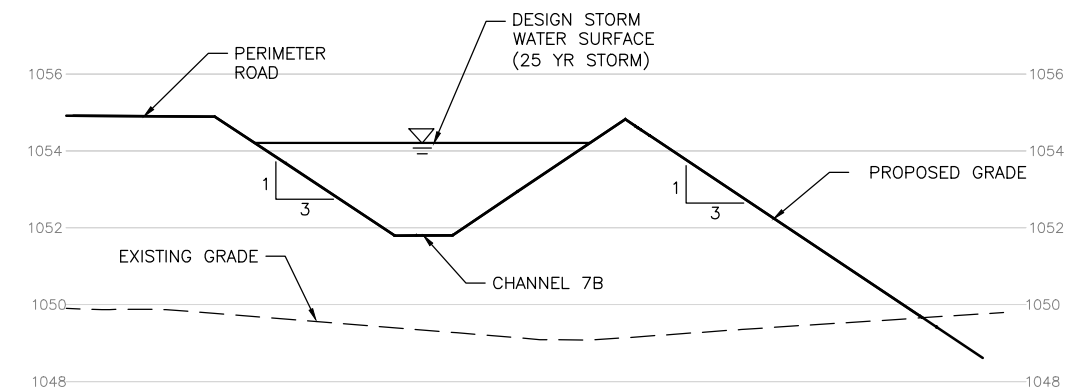

B SECTION
 SCALE IN FEET (HORIZONTAL): 0, 5, 10
 SCALE IN FEET (VERTICAL): 0, 2.5, 5

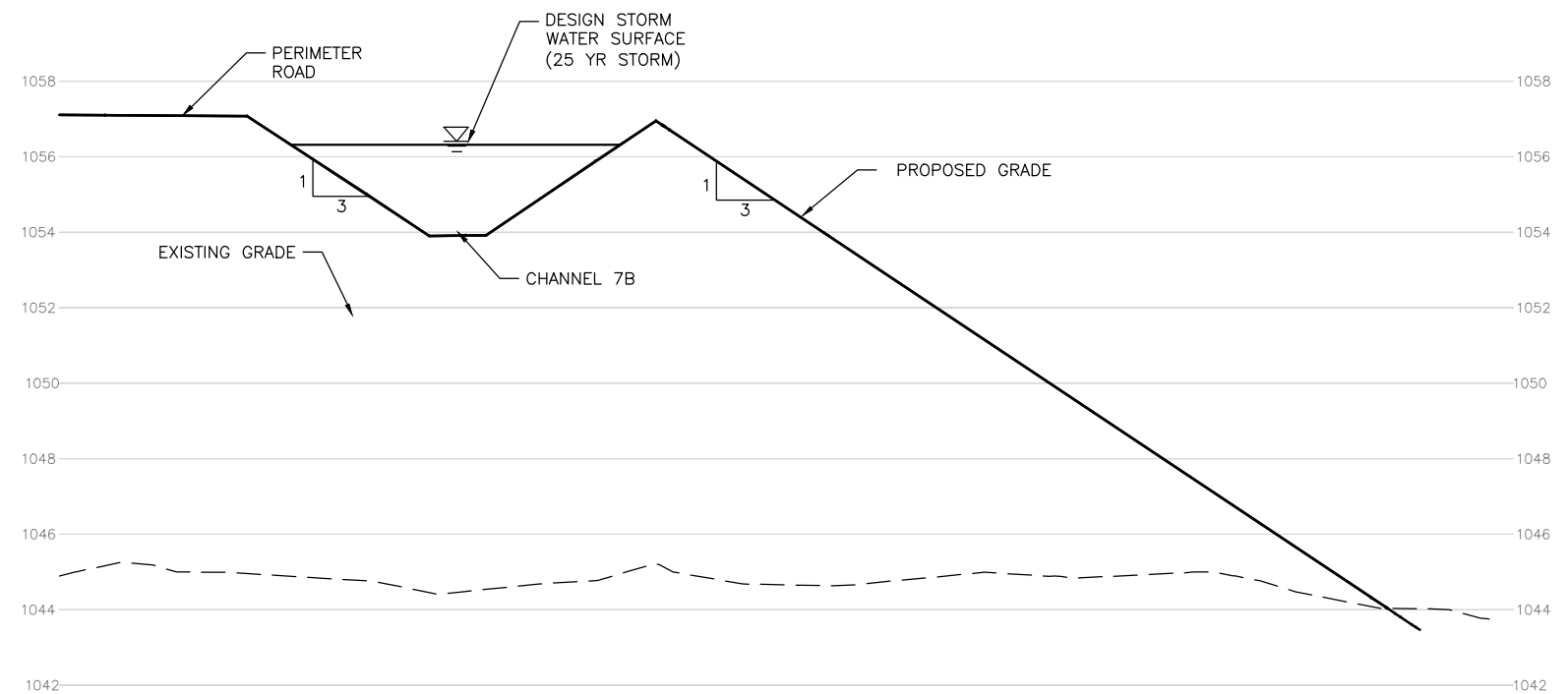

C SECTION
 SCALE IN FEET (HORIZONTAL): 0, 5, 10
 SCALE IN FEET (VERTICAL): 0, 2.5, 5



NO.	REVISION	DATE	BY
1.	2nd TECHNICAL NOD	03/2025	STV

VERIFY SCALE BAR LENGTH EQUALS ONE INCH ON ORIGINAL DRAWING. VERIFY LENGTH ON THIS SHEET AND ADJUST SCALE ACCORDINGLY.

CITY OF DEL RIO LANDFILL NO. 207C
 MAJOR PERMIT AMENDMENT
 CHANNEL 7B PROFILE AND
 CROSS SECTION

DESIGN: T. METAFERIA
 DRAWN: T. METAFERIA
 REVIEW: B. HINDMAN
 CP&Y: DELR200302
 CLIENT: CITY OF DEL RIO

FIGURE
 IIIH-C-11A

PRINTED BY: Metaferia
 FILE PATH: C:\pwworking\kingstvw\st\metaferial\0942276\DEL200302\Figure IIIH-C-11A.dwg

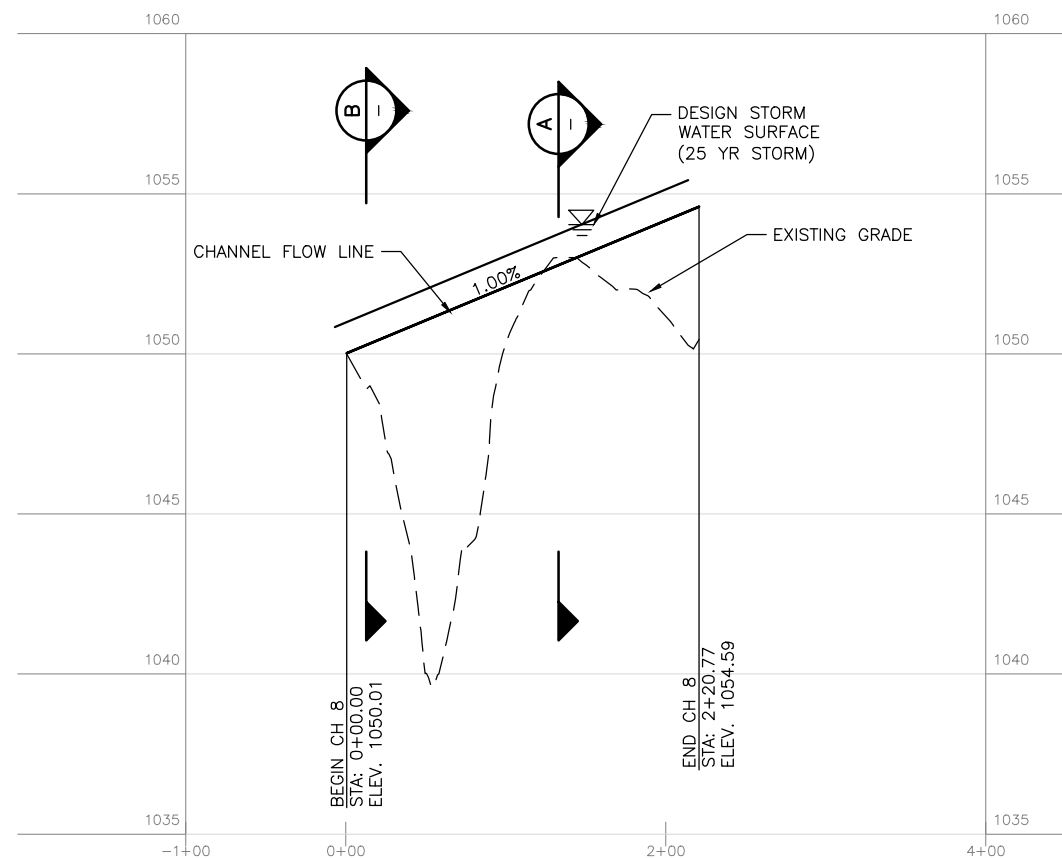

CH8 CHANNEL 8 PROFILE
 IIIH-C-4
 0 60 120
 SCALE IN FEET (HORIZONTAL)
 0 3 6
 SCALE IN FEET (VERTICAL)

Channel	Station	Flow Rate (cfs)	Bottom Slope %	Bottom Width (ft)	Normal Depth (ft)	Flow Vel. (fps)
CH8	0+00.00 3+27.78	6.6	1.00%	0	0.90	2.82

THE FOLLOWING WAS USED TO SELECT THE TYPE OF CHANNEL LINING MATERIAL
 - VEGETATION WILL BE USED IN ALL AREAS WHERE VELOCITIES ARE LESS THAN 5 FT/S.
 - TURF REINFORCEMENT MATTING WILL BE USED IN CHANNEL SECTIONS THAT HAVE VELOCITIES BETWEEN 5 FT/S AND 13 FT/S.

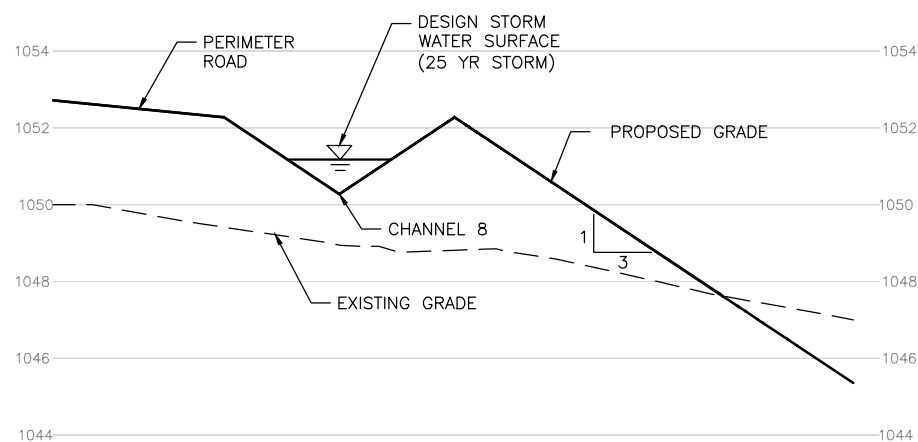

A SECTION
 0 5 10
 SCALE IN FEET (HORIZONTAL)
 0 2.5 5
 SCALE IN FEET (VERTICAL)

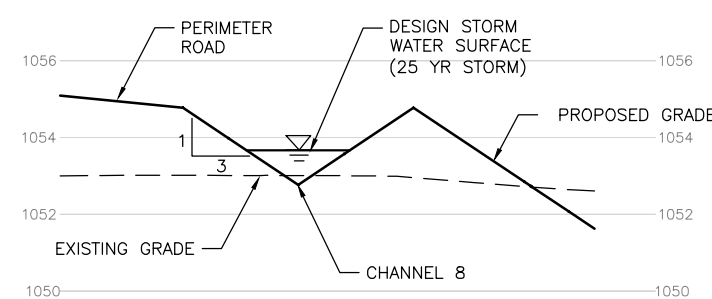

B SECTION
 0 5 10
 SCALE IN FEET (HORIZONTAL)
 0 2.5 5
 SCALE IN FEET (VERTICAL)

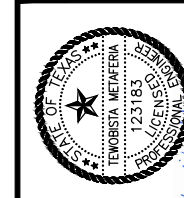

NO.	REVISION	BY	DATE
1.	2nd TECHNICAL NOD	STV	03/2025

VERIFY SCALE BAR LENGTH EQUALS ONE INCH ON ORIGINAL DRAWING. VERIFY LENGTH ON THIS SHEET AND ADJUST SCALE ACCORDINGLY.

CITY OF DEL RIO LANDFILL NO. 207C
 MAJOR PERMIT AMENDMENT

CHANNEL 8 PROFILE AND
 CROSS SECTION

DESIGN: T. METAFERIA
 DRAWN: T. METAFERIA
 REVIEW: B. HINDMAN
 CP&Y: DELR200302
 CLIENT: CITY OF DEL RIO

FIGURE
 IIIH-C-12

FOR PERMITTING PURPOSES ONLY

LEGEND

	PERMIT BOUNDARY
	CLOSED CELL BOUNDARY
	LIMIT OF WASTE
	FINAL COVER GRADES
	EXISTING GRADES
	PERIMETER CHANNEL
	SWALES
	PROPOSED SITE FENCE
	EXISTING CHUTE
	CHUTES
	PROPOSED GAS PROBE
	PROPOSED GAS VENTS

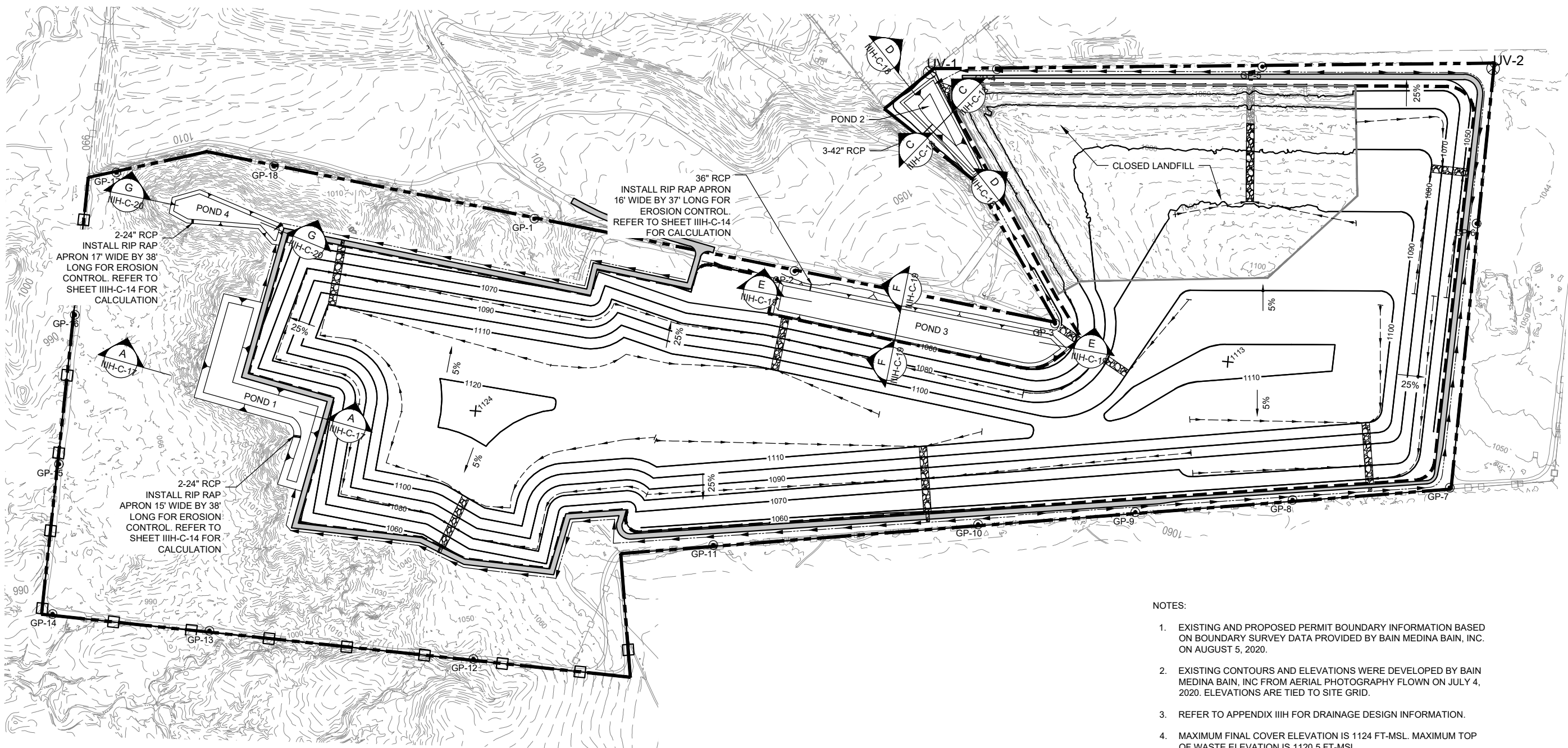
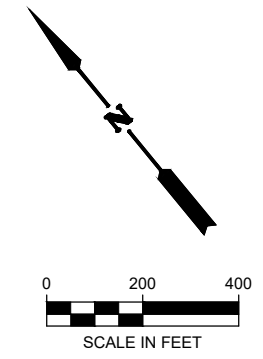

- NOTES:**
- EXISTING AND PROPOSED PERMIT BOUNDARY INFORMATION BASED ON BOUNDARY SURVEY DATA PROVIDED BY BAIN MEDINA BAIN, INC. ON AUGUST 5, 2020.
 - EXISTING CONTOURS AND ELEVATIONS WERE DEVELOPED BY BAIN MEDINA BAIN, INC FROM AERIAL PHOTOGRAPHY FLOWN ON JULY 4, 2020. ELEVATIONS ARE TIED TO SITE GRID.
 - REFER TO APPENDIX IIIH FOR DRAINAGE DESIGN INFORMATION.
 - MAXIMUM FINAL COVER ELEVATION IS 1124 FT-MSL. MAXIMUM TOP OF WASTE ELEVATION IS 1120.5 FT-MSL.
 - TYPICAL TOPSLOPE IS 5%. TYPICAL SIDESLOPES ARE 4H:1V EXCEPT IN THE AREA OF THE CLOSED PORTION OF THE LANDFILL IN WHICH THE SIDESLOPES ARE 5H:1V.



NO.	2ND TECHNICAL NOD	REVISION	BY	DATE
1.			STV	03/2025

VERIFY SCALE BAR LENGTH EQUALS ONE INCH ON ORIGINAL DRAWING. VERIFY LENGTH ON THIS SHEET 0' AND ADJUST SCALE ACCORDINGLY.

CITY OF DEL RIO LANDFILL NO. 207C
MAJOR PERMIT AMENDMENT

POND PLAN

DESIGN: T. METAFERIA
DRAWN: T. METAFERIA
REVIEW: B. HINDMAN
CP&Y: DELR200302
CLIENT: CITY OF DEL RIO

FIGURE
IIIL-H-16

FOR PERMITTING PURPOSES ONLY

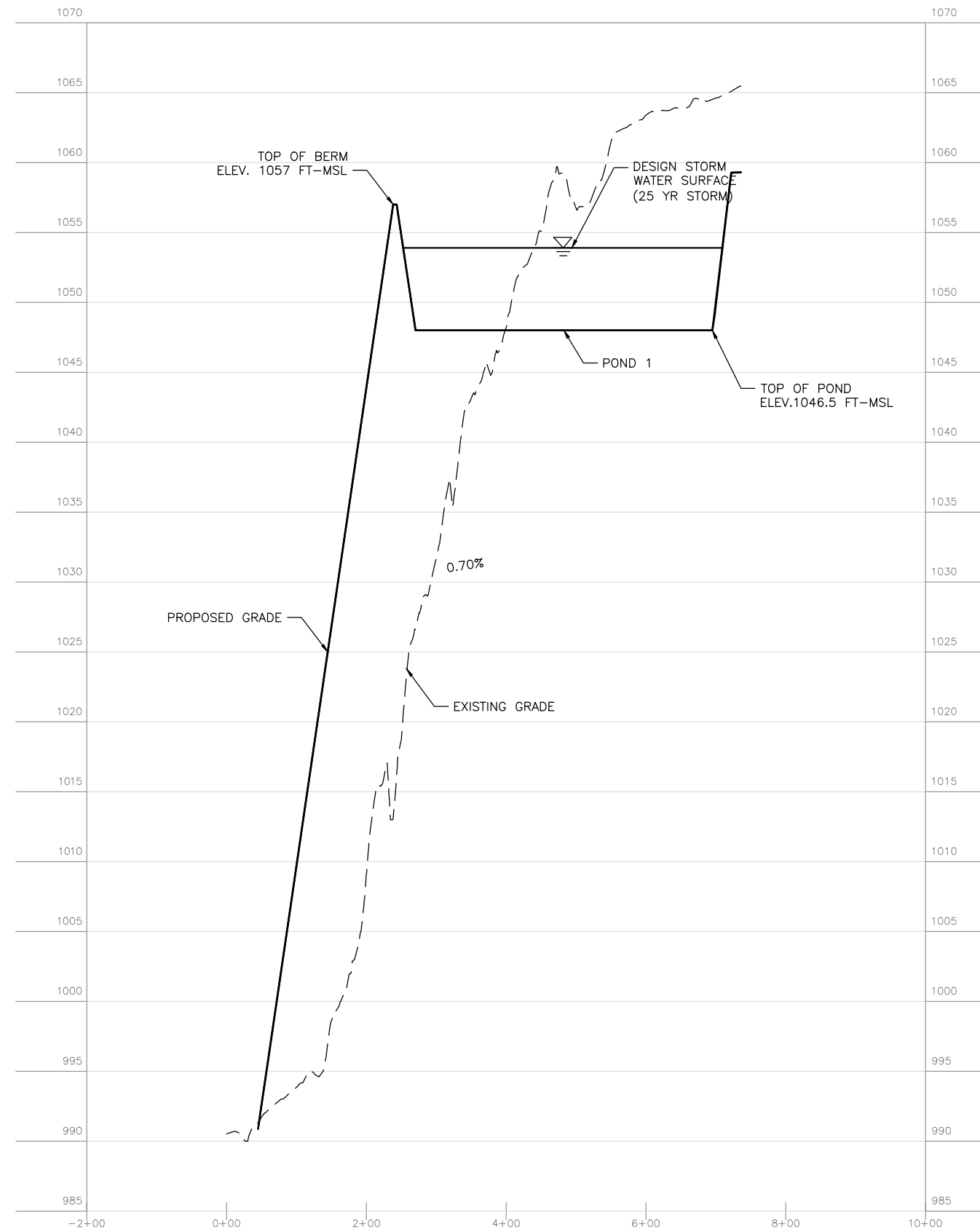

P1
IIIH-C-17
POND 1 SECTION
 0 100 200
 SCALE IN FEET (HORIZONTAL)
 0 5 10
 SCALE IN FEET (VERTICAL)

PRINTED BY: Metaferia
 FILE PATH: C:\pwworking\kingstvw_st\metaferial\0942276\DELR200302\Figure IIIH-C-17.dwg



NO.	REVISION	BY	DATE
1.	2nd TECHNICAL NOD	STV	03/2025

VERIFY SCALE BAR LENGTH EQUALS ONE INCH ON ORIGINAL DRAWING. VERIFY LENGTH ON THIS SHEET AND ADJUST SCALE ACCORDINGLY.

0 1" AND ADJUST SCALE ACCORDINGLY.

CITY OF DEL RIO LANDFILL NO. 207C
 MAJOR PERMIT AMENDMENT

POND 1 SECTION

DESIGN: T. METAFERIA
 DRAWN: T. METAFERIA
 REVIEW: B. HINDMAN
 CP&Y: DELR200302
 CLIENT: CITY OF DEL RIO

FIGURE
 IIIH-C-17

FOR PERMITTING PURPOSES ONLY

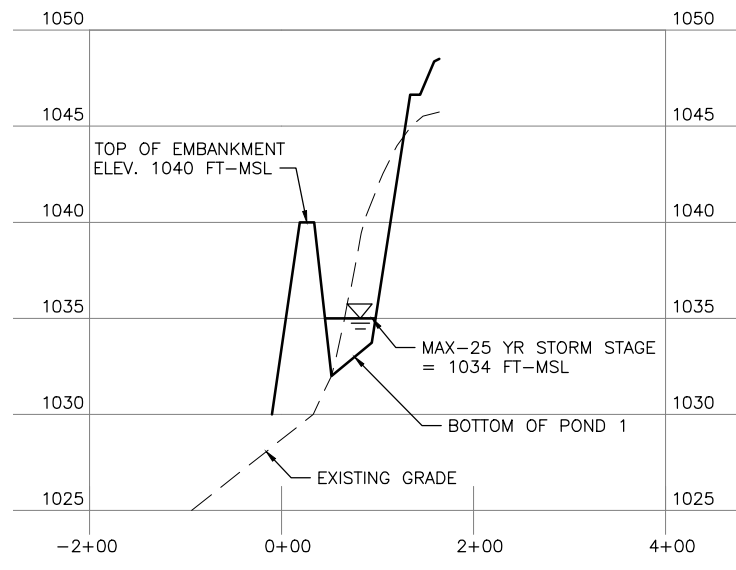

C POND 2 SECTION C
 IIII-H-C-18
 0 100 200
 SCALE IN FEET (HORIZONTAL)
 0 5 10
 SCALE IN FEET (VERTICAL)

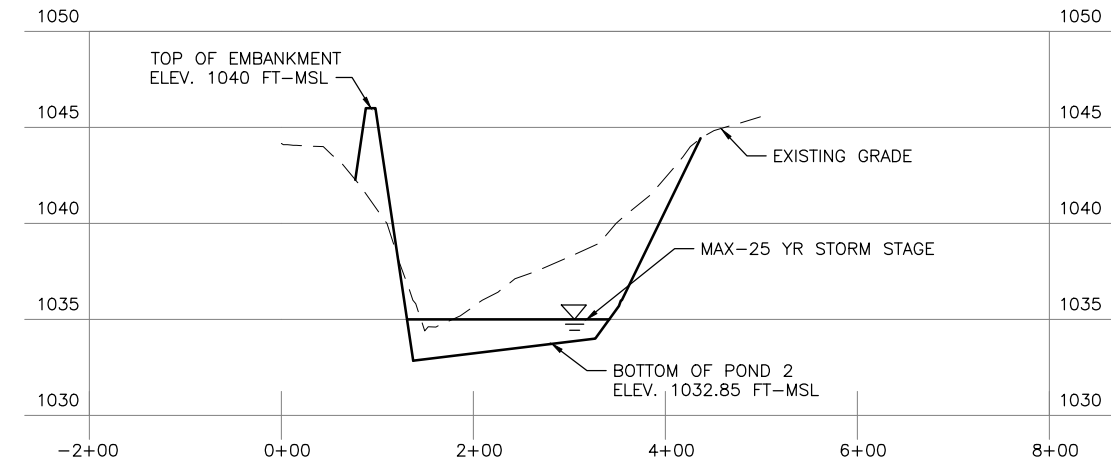

D POND 2 SECTION D
 IIII-H-C-18
 0 100 200
 SCALE IN FEET (HORIZONTAL)
 0 5 10
 SCALE IN FEET (VERTICAL)



NO.	2ND TECHNICAL NOD	REVISION	BY	DATE
1			STV	03/2025

VERIFY SCALE BAR LENGTH EQUALS ONE INCH ON ORIGINAL DRAWING. VERIFY LENGTH ON THIS SHEET AND ADJUST SCALE ACCORDINGLY.

CITY OF DEL RIO LANDFILL NO. 207C
 MAJOR PERMIT AMENDMENT

POND 2 SECTION

DESIGN: T. METAFERIA
 DRAWN: T. METAFERIA
 REVIEW: B. HINDMAN
 CP&Y: DELR200302
 CLIENT: CITY OF DEL RIO

FIGURE
 IIII-H-18

PRINTED BY: Metaferia T
 FILE PATH: C:\pwworking\King\stvw..._st\Time\aterial\ad0942276\DELR1900546 Figure IIII-H-C-18.dwg

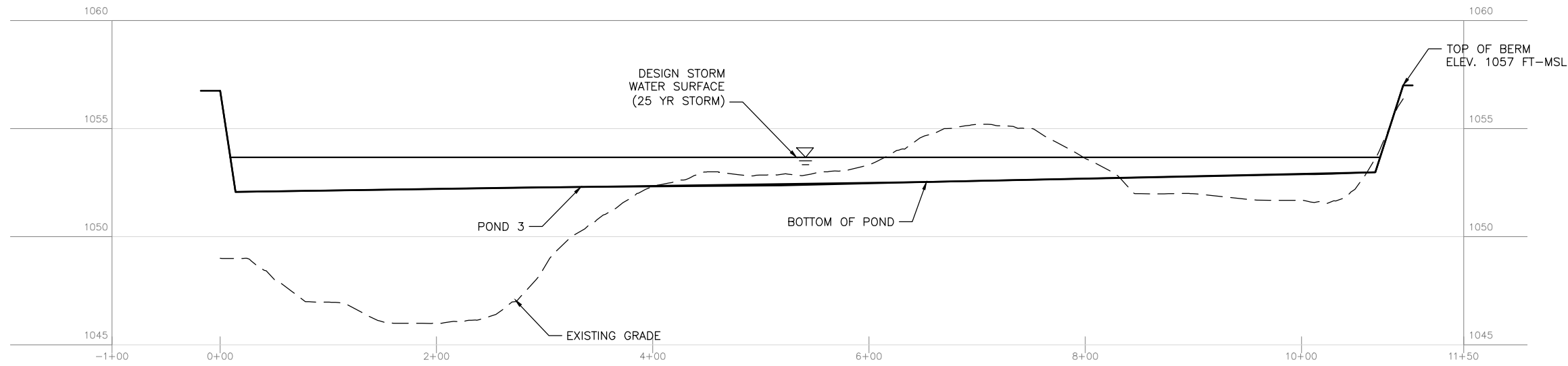

E POND 3 SECTION E
 IIIH-C-16
 0 60 120
 SCALE IN FEET (HORIZONTAL)
 0 3 6
 SCALE IN FEET (VERTICAL)

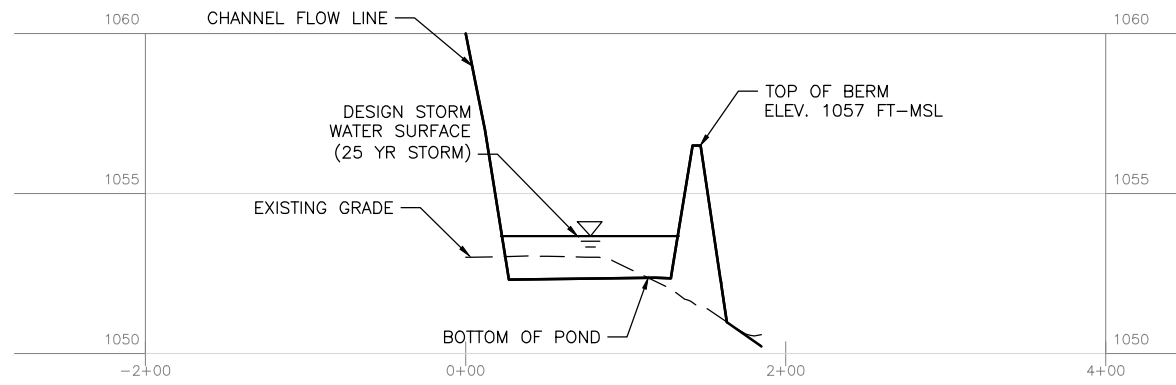

F POND 3 SECTION F
 IIIH-C-16
 0 60 120
 SCALE IN FEET (HORIZONTAL)
 0 3 6
 SCALE IN FEET (VERTICAL)



NO.	REVISION	BY	DATE
1.	2nd TECHNICAL NOD	STV	03/2025

VERIFY SCALE BAR LENGTH EQUALS ONE INCH ON ORIGINAL DRAWING. VERIFY LENGTH ON THIS SHEET 0 AND ADJUST SCALE ACCORDINGLY.

CITY OF DEL RIO LANDFILL NO. 207C
 MAJOR PERMIT AMENDMENT

POND 3 SECTION

DESIGN: T. METAFERIA
 DRAWN: T. METAFERIA
 REVIEW: B. HINDMAN
 CP&Y: DELR200302
 CLIENT: CITY OF DEL RIO

FIGURE
 IIIH-C-19

FOR PERMITTING PURPOSES ONLY

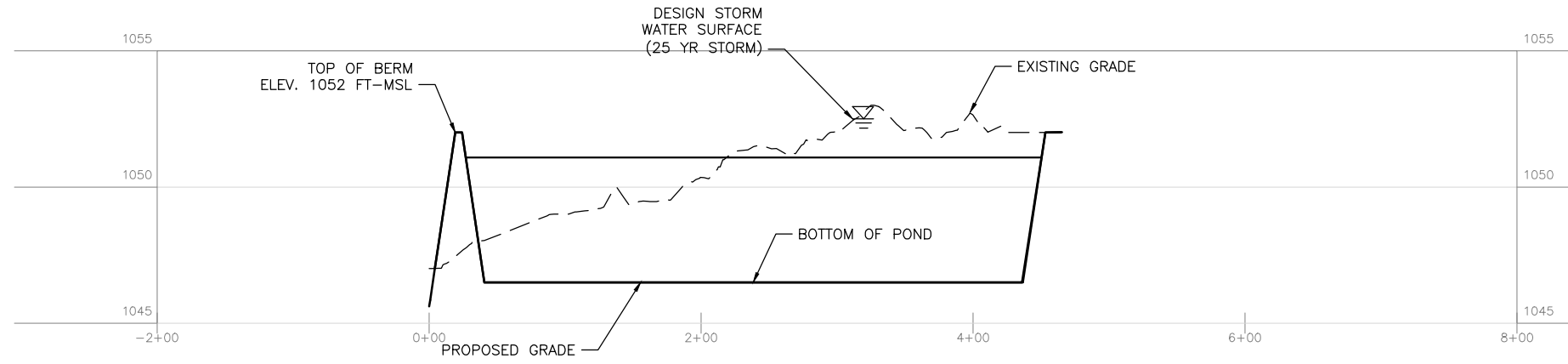

G POND 4 SECTION F
 IIIH-C-20
 0 60 120
 SCALE IN FEET (HORIZONTAL)
 0 3 6
 SCALE IN FEET (VERTICAL)



NO.	REVISION	BY	DATE
1.	2nd TECHNICAL NOD	STV	03/2025

VERIFY SCALE BAR LENGTH EQUALS ONE INCH ON ORIGINAL DRAWING. VERIFY LENGTH ON THIS SHEET AND ADJUST SCALE ACCORDINGLY.

CITY OF DEL RIO LANDFILL NO. 207C
 MAJOR PERMIT AMENDMENT

POND 4 SECTION

DESIGN: T. METAFERIA
 DRAWN: T. METAFERIA
 REVIEW: B. HINDMAN
 CP&Y: DELR200302
 CLIENT: CITY OF DEL RIO

FIGURE
 IIIH-C-20

FOR PERMITTING PURPOSES ONLY

Appendix IIIH-D. Final Cover Erosion Control Structure Design



TABLE OF CONTENTS

Drainage Swale Design IIIH-D-1
Drainage Letdown/Chute Design IIIH-D-7

LIST OF FIGURES

Typical Swale Drainage Areas IIIH-D-2
Letdown Drainage Areas IIIH-C-8



1.0 DRAINAGE SWALE DESIGN

Typical Swale Design Summary:

- Typical swale drainage areas analyzed are shown on sheet IIIH-D-2.
- Hydraulic calculations are summarized on page IIIH-D-4.
- Maximum normal depth is 1.47 feet (Drainage Area SW4).
- Maximum flow velocity is 2.75 fps (Drainage Area SW4).
- Vegetation will be established on the swales to protect against erosion.

Typical swale drainage areas were selected such that all slope conditions (5% and 25%) are included in this analysis. Additionally, swales with large individual drainage areas and short and long swale lengths are included in this analysis. [In addition, swales shall be constructed at every 180 feet or less and shall not exceed a length of 578 feet.](#)

PRINTED BY: Metaferia
 FILE PATH: C:\working\stvw_s\metafe\del_r2000302\Figure IIIH-D-2.dwg

LEGEND

- (T7) DRAINAGE AREA DESIGNATION
- DRAINAGE BOUNDARY
- PERIMETER CHANNEL
- GP-5 PROPOSED GAS PROBE
- ⊕ UV-1 PROPOSED GAS VENTS
- PERMIT BOUNDARY
- CLOSED CELL BOUNDARY
- LIMIT OF WASTE
- 1090 FINAL COVER CONTOURS
- 1060 EXISTING CONTOURS
- SWALES
- EXISTING SITE FENCE
- PROPOSED SITE FENCE
- ▨ EXISTING CHUTE
- ▨ CHUTES

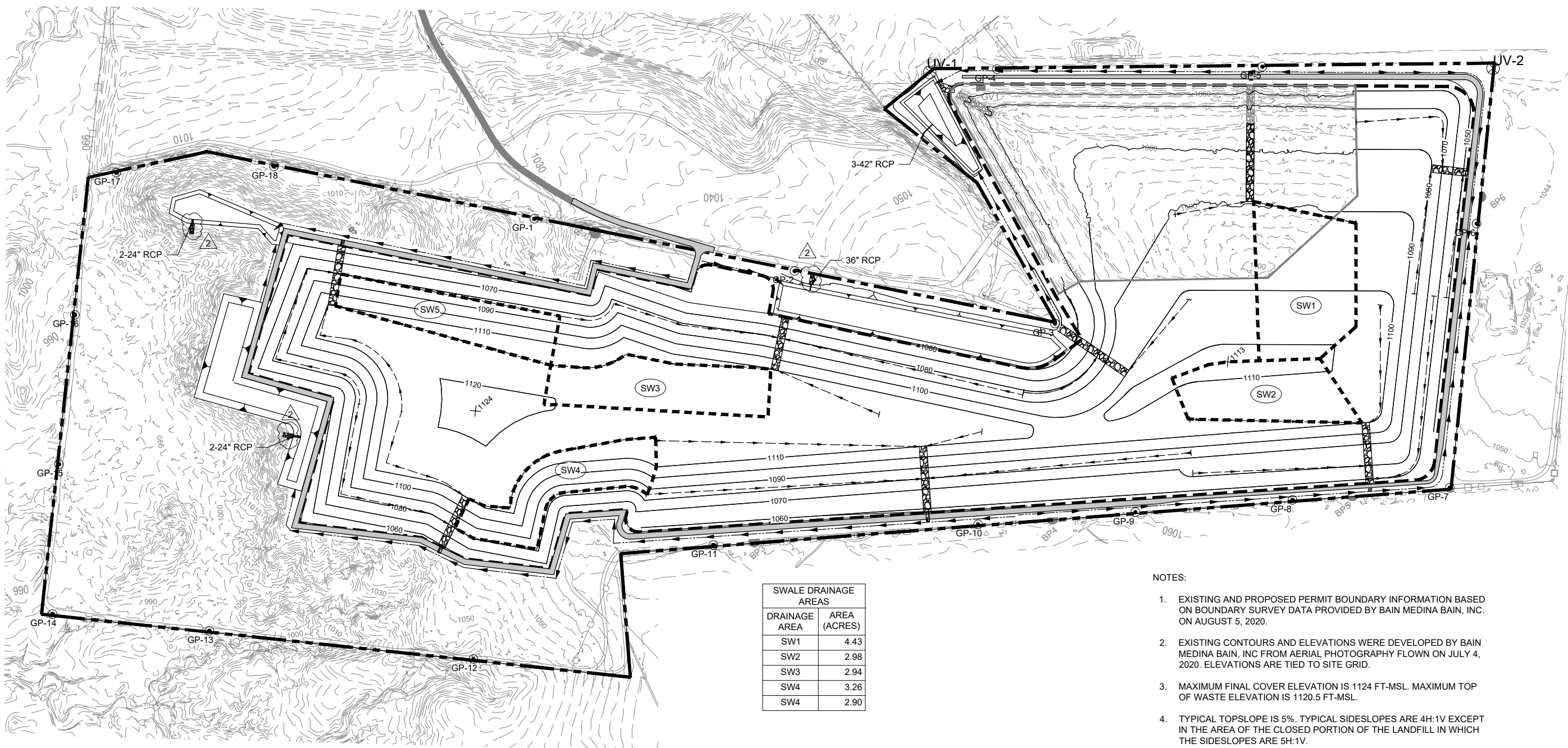
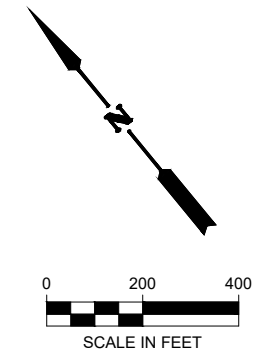

SWALE DRAINAGE AREAS	
DRAINAGE AREA	AREA (ACRES)
SW1	4.43
SW2	2.98
SW3	2.94
SW4	3.26
SW5	2.90

NOTES:

- EXISTING AND PROPOSED PERMIT BOUNDARY INFORMATION BASED ON BOUNDARY SURVEY DATA PROVIDED BY BAIN MEDINA BAIN, INC. ON AUGUST 5, 2020.
- EXISTING CONTOURS AND ELEVATIONS WERE DEVELOPED BY BAIN MEDINA BAIN, INC FROM AERIAL PHOTOGRAPHY FLOWN ON JULY 4, 2020. ELEVATIONS ARE TIED TO SITE GRID.
- MAXIMUM FINAL COVER ELEVATION IS 1124 FT-MSL. MAXIMUM TOP OF WASTE ELEVATION IS 1120.5 FT-MSL.
- TYPICAL TOPSLOPE IS 5%. TYPICAL SIDESLOPES ARE 4H:1V EXCEPT IN THE AREA OF THE CLOSED PORTION OF THE LANDFILL IN WHICH THE SIDESLOPES ARE 5H:1V.



NO.	REVISION	DATE	BY	STV	STV
2	2ND TECHNICAL NOD	03/2025			
1	1ST TECHNICAL NOD	08/2024			

VERIFY SCALE BAR LENGTH EQUALS ONE INCH ON ORIGINAL DRAWING. VERIFY LENGTH ON THIS SHEET 0" AND ADJUST SCALE ACCORDINGLY.

CITY OF DEL RIO LANDFILL NO. 207C
 MAJOR PERMIT AMENDMENT

TYPICAL SWALE
 DRAINAGE AREAS

DESIGN: T. METAFERIA
 DRAWN: T. METAFERIA
 REVIEW: B. HINDMAN
 CP&Y: DELR200302
 CLIENT: CITY OF DEL RIO

FIGURE
 IIIH-D-2

FOR PERMITTING PURPOSES ONLY

PRINTED BY: Metaferia
 FILE PATH: C:\working\stvw_s\w\metaferia\0942276\DEL2000302\Figure IIIH-D-8.dwg

LEGEND

- LD2 DRAINAGE AREA DESIGNATION
- DRAINAGE BOUNDARY
- PERIMETER CHANNEL
- GP-5 PROPOSED GAS PROBE
- ⊕ UV-1 PROPOSED GAS VENTS
- PERMIT BOUNDARY
- CLOSED CELL BOUNDARY
- LIMIT OF WASTE
- 1090 FINAL COVER CONTOURS
- 1060 EXISTING CONTOURS
- SWALES
- EXISTING SITE FENCE
- PROPOSED SITE FENCE
- ▨ EXISTING CHUTE
- ▨ CHUTES

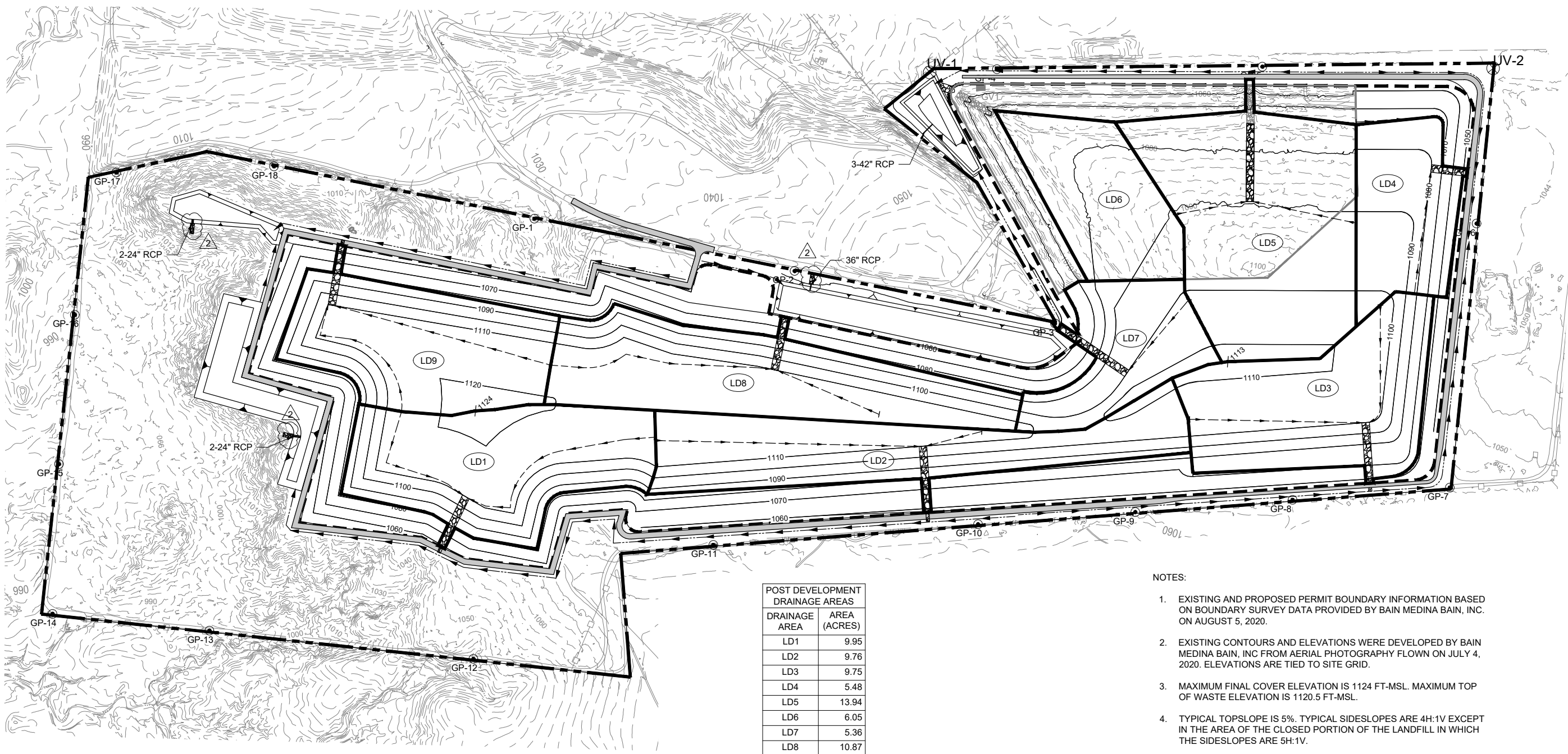
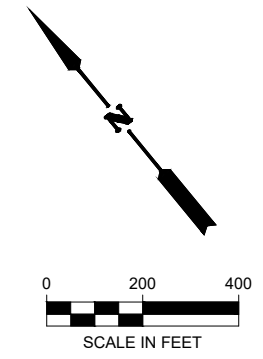

POST DEVELOPMENT DRAINAGE AREAS	
DRAINAGE AREA	AREA (ACRES)
LD1	9.95
LD2	9.76
LD3	9.75
LD4	5.48
LD5	13.94
LD6	6.05
LD7	5.36
LD8	10.87
LD9	9.11

- NOTES:
- EXISTING AND PROPOSED PERMIT BOUNDARY INFORMATION BASED ON BOUNDARY SURVEY DATA PROVIDED BY BAIN MEDINA BAIN, INC. ON AUGUST 5, 2020.
 - EXISTING CONTOURS AND ELEVATIONS WERE DEVELOPED BY BAIN MEDINA BAIN, INC FROM AERIAL PHOTOGRAPHY FLOWN ON JULY 4, 2020. ELEVATIONS ARE TIED TO SITE GRID.
 - MAXIMUM FINAL COVER ELEVATION IS 1124 FT-MSL. MAXIMUM TOP OF WASTE ELEVATION IS 1120.5 FT-MSL.
 - TYPICAL TOPSLOPE IS 5%. TYPICAL SIDESLOPES ARE 4H:1V EXCEPT IN THE AREA OF THE CLOSED PORTION OF THE LANDFILL IN WHICH THE SIDESLOPES ARE 5H:1V.



NO.	REVISION	DATE
2	2ND TECHNICAL NOD	03/2025
1	1ST TECHNICAL NOD	08/2024

VERIFY SCALE BAR LENGTH EQUALS ONE INCH ON ORIGINAL DRAWING. VERIFY LENGTH ON THIS SHEET AND ADJUST SCALE ACCORDINGLY.

CITY OF DEL RIO LANDFILL NO. 207C
 MAJOR PERMIT AMENDMENT

LETDOWN DRAINAGE AREAS

DESIGN: T. METAFERIA
 DRAWN: T. METAFERIA
 REVIEW: B. HINDMAN
 CP&Y: DELR200302
 CLIENT: CITY OF DEL RIO

FIGURE
 IIIH-D-8

FOR PERMITTING PURPOSES ONLY

Appendix IIIH-E. Erosion Layer Evaluation



TABLE OF CONTENTS

1.0 INTRODUCTION IIIH-E-1

2.0 FINAL COVER EROSION LAYER EVALUATION IIIH-E-2

3.0 INTERMEDIATE COVER EROSION AND SEDIMENTATION CONTROL IIIH-E-3

 3.1 Surface Water Diversions..... IIIH-E-3

 3.2 Erosion Control Best Management Practices (BMPs)..... IIIH-E-4

 3.3 Schedule, Maintenance and Recordkeeping IIIH-E-4

4.0 DAILY COVER AND NON-EXTERNAL SIDE SLOPES EROSION AND SEDIMENTATIONAL CONTROL..... IIIH-E-5

LIST OF FIGURES

Longest and Typical Swale Lengths IIIH-E-6



2.0 FINAL COVER EROSION LAYER EVALUATION

This appendix presents the supporting documentation for evaluation of the thickness of the erosion layer for the final cover system at the Del Rio Landfill. The evaluation is based on the premise of adding excess soil to increase the time required before maintenance is needed as recommended in the EPA Solid Waste Disposal Facility Criteria Technical Manual (EPA 530-R-93-017, November 1993). The design procedure is as follows:

- Minimum thickness of the erosion layer at the end of the 30-year post-closure period is evaluated based on the depth of frost penetration or 6 inches, whichever is greater. For Val Verde County, the approximate depth of frost penetration is approximately ~~0.56-1~~ inches (see IIIH-~~E-D-140~~). Therefore, the minimum erosion layer thickness is ~~6.04~~ inches.
- Soil loss is calculated using the Universal Soil Loss Equation (USLE) by following SCS procedures. The soil loss is adjusted by a safety factor of 2 and is then converted to a thickness. The thickness of the soil loss over a 30-year post-closure period is added to the minimum thickness of the erosion layer (from Step 1) to yield an initial thickness to be placed at closure of the site. According to the USLE, the typical 5 percent topslope and 25 percent side slope require a minimum of ~~6.03~~ inches ~~and 6.71 inches, respectively~~, for the erosion layer. These USLE requirements include the 6-inch minimum required by regulations. Conservatively, a 12-inch erosion layer is proposed over final cover.
- Stormwater flows over the final cover system by (1) sheet flow over the topslope and sideslopes and (2) channelized flow in the drainage berms (or swales). The letdown structures are lined with gabions to prevent erosion given that the velocities in the letdowns are over 5 ft/sec.
- Sheet flow velocities for the topslope and sideslope cases for a 25-year storm event are calculated to be less than permissible nonerosive velocities. A permissible nonerosive velocity is defined as 5.0 ft/sec or less.
- Channelized flow for drainage swales is also calculated to be less than permissible nonerosive velocities. The supporting calculations are presented on pages IIIH-D-4.
- Vegetation for the site will be native and introduced grasses with root depths of 6 inches to 8 inches. The erosion layer shall also include a mixture of Bermuda, vetch, rye, wheat grass, wildflowers, and flowering plants. The TxDOT seeding for Val Verde County (Laredo District) is shown on pages IIIH-E-20 through IIIH-E-23.
- Native and introduced grasses will be hydroseeded with fertilizer on the disked (parallel to contours) erosion layer upon final grading. Temporary cold weather vegetation will be established if needed. Irrigation will be employed for 6 to 8 weeks or until vegetation is well established. Erosion control measures such as silt fences and straw bales will be used to minimize erosion until the vegetation is established. Areas that experience erosion or do not readily vegetate after hydroseeding will be reseeded until vegetation is established or the soil will be replaced with soil that will support the grasses.
- Swales shall be constructed at every 180 feet or less and shall not exceed a length of 578 feet.
- A minimum of 90% vegetation cover shall be maintained for final cover.

PRINTED BY: Metaferia
 FILE PATH: C:\working\stvw_s\w\metaferia\0942276\DEL2000302\Figure IIIH-E-6.dwg

LEGEND

	PERMIT BOUNDARY
	CLOSED CELL BOUNDARY
	LIMIT OF WASTE
	FINAL COVER CONTOURS
	EXISTING CONTOURS
	SWALES
	EXISTING SITE FENCE
	PROPOSED SITE FENCE
	EXISTING CHUTE
	CHUTES
	PERIMETER CHANNEL
	PROPOSED GAS PROBE
	PROPOSED GAS VENTS

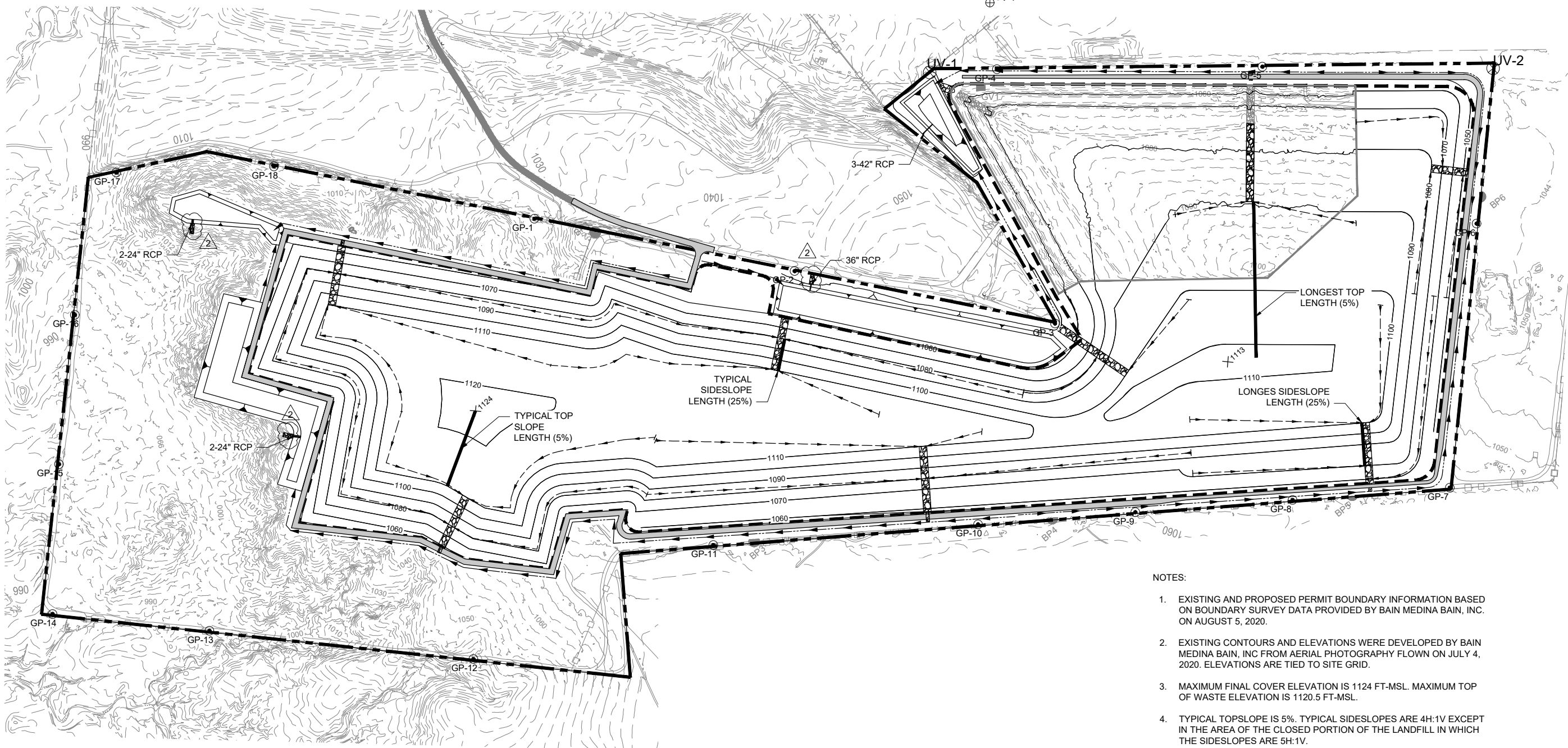
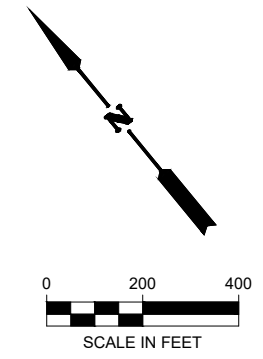

- NOTES:**
1. EXISTING AND PROPOSED PERMIT BOUNDARY INFORMATION BASED ON BOUNDARY SURVEY DATA PROVIDED BY BAIN MEDINA BAIN, INC. ON AUGUST 5, 2020.
 2. EXISTING CONTOURS AND ELEVATIONS WERE DEVELOPED BY BAIN MEDINA BAIN, INC FROM AERIAL PHOTOGRAPHY FLOWN ON JULY 4, 2020. ELEVATIONS ARE TIED TO SITE GRID.
 3. MAXIMUM FINAL COVER ELEVATION IS 1124 FT-MSL. MAXIMUM TOP OF WASTE ELEVATION IS 1120.5 FT-MSL.
 4. TYPICAL TOPSLOPE IS 5%. TYPICAL SIDESLOPES ARE 4H:1V EXCEPT IN THE AREA OF THE CLOSED PORTION OF THE LANDFILL IN WHICH THE SIDESLOPES ARE 5H:1V.



NO.	REVISION	DATE
2.	2ND TECHNICAL NOD	03/2025
1.	1ST TECHNICAL NOD	08/2024

VERIFY SCALE BAR LENGTH EQUALS ONE INCH ON ORIGINAL DRAWING. VERIFY LENGTH ON THIS SHEET 0" AND ADJUST SCALE ACCORDINGLY.

CITY OF DEL RIO LANDFILL NO. 207C
 MAJOR PERMIT AMENDMENT

LONGEST AND TYPICAL FLOW LENGTHS

DESIGN: T. METAFERIA
DRAWN: T. METAFERIA
REVIEW: B. HINDMAN
CP&Y: DELR200302
CLIENT: CITY OF DEL RIO

FIGURE IIIH-E-6

FOR PERMITTING PURPOSES ONLY

Erosion Layer Evaluation

Client: City of Del Rio
Project: Major Permit Amendment
Description: Erosion Layer Evaluation

Date: 7/24/2024
Job No: DELR2000302
By: A. Gardner
Checked By: T. Metaferia

Purpose - Determine expected soil loss and minimum thickness for the erosion layer.

Soil Loss Equation - $A = RKL_sCP$

- Where:
- A = Soil loss (tons/ac/yr)
 - R = Rainfall factor
 - K = Soil erodibility factor
 - Ls = Slope length/slope gradient factor
 - C = Plant cover or cropping management factor
 - P = Erosion practice factor

The rainfall factor R, represents the average intensity for the maximum intensity, 30 min storm over a 22-year period of record compiled by SCS. Using Figure 1 in the TNRCC, *Use of the USLE in Final Cover/Configuration Design*, 1993. The R factor for Val Verde County is:

R = 150

The soil erodibility factor, K represents the resistance of a soil surface to erosion as a function of the soil's physical and chemical properties. Assume an organic matter content of 2% to determine the K factor. The top soil will consist of sandy clay with high organic content. Clean compost as a soil amendment may be added to final cover top soil as necessary to protect against erosion. Therefore, the following is a K value for the site.

K = 0.29

The slope length/slope gradient factor, Ls, represents the erosion of the soil due to both slope length and degree of slope. The slopes of interest are the typical side slope and top slope condition

Case 1.	Typical Top Slope	Case 2.	Longest Top Slope
Slope =	5%	Slope =	5%
Length =	298	Length =	578
Case 3.	Typical Side Slope	Case 4.	Longest Side Slope
Slope =	25%	Slope =	25%
Length =	120	Length =	160

The L_s factors were determined using the TNRCC, *Use of the USLE in Final Cover/Configuration Design*, 1993.

Case	Slope (%)	Slope Length (ft)	L _s
1. Typical Top Slope	5	298	0.9
2. Longest Top Slope	5	578	1.5
3. Typical Side Slope	25	120	6.5
4. Longest Side Slope	25	160	8.0

Erosion Layer Evaluation

Client: City of Del Rio
Project: Major Permit Amendment
Description: Erosion Layer Evaluation

Date: 7/24/2024
Job No: DELR2000302
By: A. Gardner
Checked By: T. Metaferia

Purpose - Determine expected soil loss and minimum thickness for the erosion layer.

The plant cover or cropping management factor C, represents the percentage of soil loss that would occur if surfaces were partially protected by some combination of cover and management practices. C factor for Permanent Pasture, Range, and Idle Land with No Appreciable Canopy has the following relation with percent ground cover (GC) based on TNRCC, *Use of the USLE in Final Cover/Configuration Design*, 1993.

% GC	C Factor
0	0.45
20	0.2
40	0.1
60	0.042
80	0.013
95	0.003

$$C = 0.5837e^{-0.0502 * \%GC}$$

$$C = 0.0064 \quad (\text{for } 90\% \text{ ground cover})$$

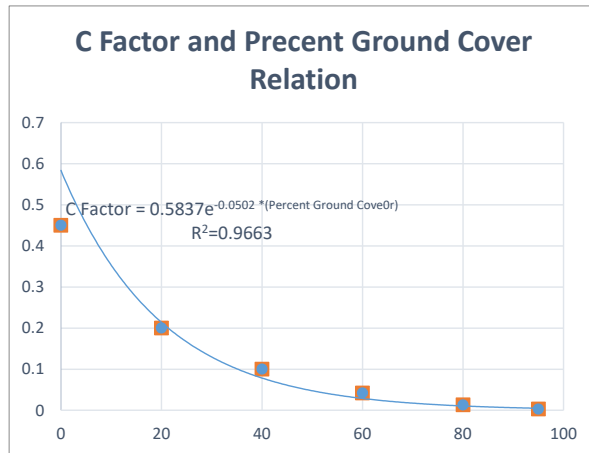

Erosion control practice factor, P measures the effect of control practices done on site. These practices could involve drainage patterns, runoff concentration, and runoff velocity.

$$P = 1.00$$

Slope Condition	R	K	L _s	C	P	A (tons/ac/yr)
1. Typical Top Slope 5% slope 250 ft length	150	0.29	0.9	0.0064	1	0.25
2. Longest Top Slope 5% slope 415 ft length	150	0.29	1.5	0.0064	1	0.42
3. Typical Side Slope 25% slope 120 ft length	150	0.29	6.5	0.0064	1	1.81
4. Longest Side Slope 25% slope 163 ft length	150	0.29	8	0.0064	1	2.23

Note: Erosion layer will be maintained to provide 90% ground coverage

Erosion layer thickness calculations:

Minimum thickness of the erosion layer at the end of the 30-year post-closure period is evaluated based on the depth of frost penetration or 6 inches, whichever is greater. For Val Verde County, the approximate depth of frost penetration is approximately 0.5 inches (see IIIH-E-14). Therefore, the minimum erosion layer thickness is 6.0 inches.

$$T_{er} = 6 \text{ in} + (AYF(2000\text{lb/ton})(12\text{in/ft})) / (w(43,560\text{sf/ac}))$$

Where:
 T_{er} = Erosion layer thickness
 A = Soil loss (ton/ac/yr)
 Y = Postclosure Period (yr)
 F = Factor of Safety
 w = Specific weight of soil (pcf)

Y = 30 yr
 F = 2
 w = 110 pcf

Erosion Layer Evaluation

Client: City of Del Rio
Project: Major Permit Amendment
Description: Erosion Layer Evaluation

Date: 7/24/2024
Job No: DELR2000302
By: A. Gardner
Checked By: T. Metaferia

Purpose - Determine expected soil loss and minimum thickness for the erosion layer.

1. Typical Top Slope Thickness:			
T _{el} Required Thickness =	6.08	6.00	in
Total Estimated Soil Loss =	0.08	0.00	in
Specified Thickness =		12.00	in
2. Longest Top Slope Thickness:			
T _{el} Required Thickness =	6.13	6.00	in
Total Estimated Soil Loss =	0.13	0.00	in
Specified Thickness =		12.00	in
3. Typical Side Slope Thickness:			
T _{el} Required Thickness =	6.14	6.00	in
Total Estimated Soil Loss =	0.14	0.00	in
Specified Thickness =		12.00	in
4. Longest Side Slope Thickness:			
T _{el} Required Thickness =	6.67	6.00	in
Total Estimated Soil Loss =	0.67	0.00	in
Specified Thickness =		12.00	in

Conclusion:

Calculated erosion losses are shown above. The erosion layer will be a minimum of 12 inches thick. As shown above, this is a conservative design considering the maximum expected soil loss for a 30 year period is 0.67 inches

Soil Loss Estimate Summary Table

Case	Slope (%)	Length (ft)	L _s	Percent Ground Cover	C Factor	A (tons/ac/yr)
Top Slope	5	298	0.90	70	0.017	0.71
Top Slope	5	298	0.90	80	0.013	0.54
Top Slope	5	298	0.90	90	0.0064	0.27
Top Slope	5	578	1.5	70	0.017	1.18
Top Slope	5	578	1.5	80	0.013	0.90
Top Slope	5	578	1.5	90	0.0064	0.45
Side Slope	25	120	6.5	70	0.017	5.13
Side Slope	25	120	6.5	80	0.013	3.92
Side Slope	25	120	6.5	90	0.0064	1.93
Side Slope	25	160	8.0	70	0.017	6.31
Side Slope	25	160	8.0	80	0.013	4.83
Side Slope	25	160	8.0	90	0.0064	2.38

Erosion Layer Evaluation

Client: City of Del Rio
Project: Major Permit Amendment
Description: Erosion Layer Evaluation

Date: 3/7/2025
Job No: DELR2000302
By: A. Gardner
Checked By: B. Hindman

Purpose - Evaluate the expected soil loss from the Intermediate Cover consistent with 30 TAC §330.305(d)(2).

Soil Loss Equation - $A = RKL_sCP$

- Where:
- A = Soil loss (tons/ac/yr)
 - R = Rainfall factor
 - K = Soil erodibility factor
 - Ls = Slope length/slope gradient factor
 - C = Plant cover or cropping management factor
 - P = Erosion practice factor

The rainfall factor R, represents the average intensity for the maximum intensity, 30 min storm over a 22-year period of record compiled by SCS. Using Figure 1 in the TNRCC, *Use of the USLE in Final Cover/Configuration Design*, 1993. The R factor for Val Verde County is:

R = 150

The soil erodibility factor, K represents the resistance of a soil surface to erosion as a function of the soil's physical and chemical properties. Assume an organic matter content of 2% to determine the K factor. The top soil will consist of sandy clay with high organic content. Clean compost as a soil amendment may be added to final cover top soil as necessary to protect against erosion. Therefore, the following is a K value for the site.

K = 0.29

The slope length/slope gradient factor, Ls, represents the erosion of the soil due to both slope length and degree of slope. The slopes of interest are the typical side slope and top slope condition

Case 1.	Typical Top Slope	Case 2.	Longest Top Slope
Slope =	5%	Slope =	5%
Length =	298	Length =	578
Case 3.	Typical Side Slope	Case 4.	Longest Side Slope
Slope =	25%	Slope =	25%
Length =	120	Length =	160

The L_s factors were determined using the TNRCC, *Use of the USLE in Final Cover/Configuration Design*, 1993.

Case	Slope (%)	Slope Length (ft)	L _s
Longest Top Slope	5	578	1.5
Longest Side Slope	25	160	8.0

Erosion Layer Evaluation

Client: City of Del Rio
Project: Major Permit Amendment
Description: Erosion Layer Evaluation

Date: 3/7/2025
Job No: DELR2000302
By: A. Gardner
Checked By: B. Hindman

Purpose - Evaluate the expected soil loss from the Intermediate Cover consistent with 30 TAC §330.305(d)(2).

Cover Management Factor

The C factor represents the effects of plants, soil cover, soil biomass, and soil disturbing activities on erosion. For intermediate cover the City will seed or sod the cover. For intermediate cover a conservative 60% cover was assumed. Additionally, while establishing intermediate cover vegetation, the city will use mulch to reduce erosion until a 60% vegetative cover can be established.

C = 0.042 60% ground cover
 C = 0.050 Mulch

Erosion contro practice factor, P measures the effect of control practicesdone on site. These practices could involve drainage patterns, runoff concentration, and runoff velocity. For purposes of calculating soil loss, the P factor is:

P = 1.00

Interim Slope Condition	R	K	L _s	C	P	A (tons/ac/yr)
1. Longest Top Slope 60% Vegetated 5% slope 415 ft length	150	0.29	1.5	0.042	1	2.74
2. Longest Top Slope Mulched 5% slope 415 ft length	150	0.29	1.5	0.05	1	3.26
3. Longest Side Slope 60% Vegetated 25% slope 163 ft length	150	0.29	8.0	0.042	1	14.62
4. Longest Side Slope Mulched 25% slope 163 ft length	150	0.29	8	0.05	1	17.40

As shown, the soil loss for both the top dome and sideslope is less than the permissible soil loss of 50 tons/acre/year for intermediate cover.

**CITY OF DEL RIO LANDFILL
VAL VERDE COUNTY, TEXAS
TCEQ PERMIT NO. MSW 207C**

**MAJOR PERMIT AMENDMENT APPLICATION
PART III – SITE DEVELOPMENT PLAN**

**APPENDIX IIIJ
GEOLOGY REPORT**

Prepared by:

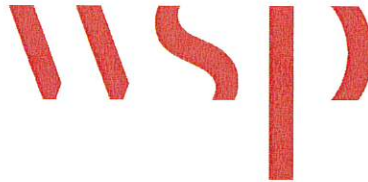

WSP USA Environment & Infrastructure Inc.
16414 San Pedro Avenue, Suite 425
San Antonio, Texas 78232

Project No. 5020210002

February 2023

Revision 1, August 2024

Revision 2, November 2024

This document is intended for permitting purposes only.

APPENDIX IIIJ-D

Site Stratigraphic Cross-Sections

Del Rio Landfill Expansion

Del Rio, Texas

1

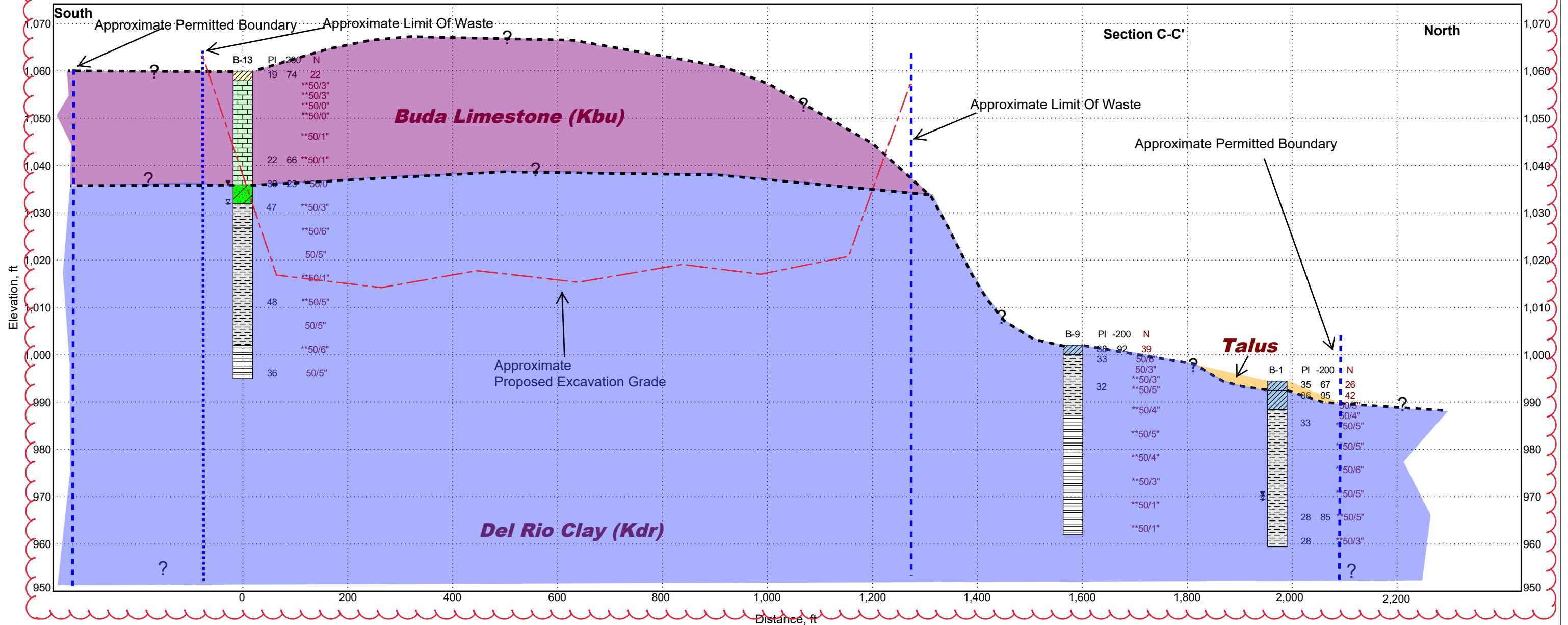

LEGEND:

- Gravelly Fat Clay
- USCS High Plasticity Clay
- Clay Shale
- Clay-Shale
- USCS Low Plasticity Clay
- Limestone
- USCS Clayey Sand

1 Revised Cross-section.

NOTES:

The represented stratigraphy is based on the geotechnical engineer's interpretation of field and laboratory data. The depth where water was first encountered during drilling is depicted with an open triangle; the depth where water rose is depicted with a solid triangle. PI and -200 represent plasticity index and fines content for the sampled interval, with data shown at the top of interval indicated on the boring logs.



Project Mngr:	SKM	Project No.	
Drawn By:	MEB		2020-221
Checked By:	JRM	Scale:	AS SHOWN
Reviewed By:	SKM	Date:	11-19-2024

GENERALIZED STRATIGRAPHY

City of Del Rio Landfill Expansion Project

Del Rio, Val Verde County, Texas

Del Rio Landfill Expansion

Del Rio, Texas

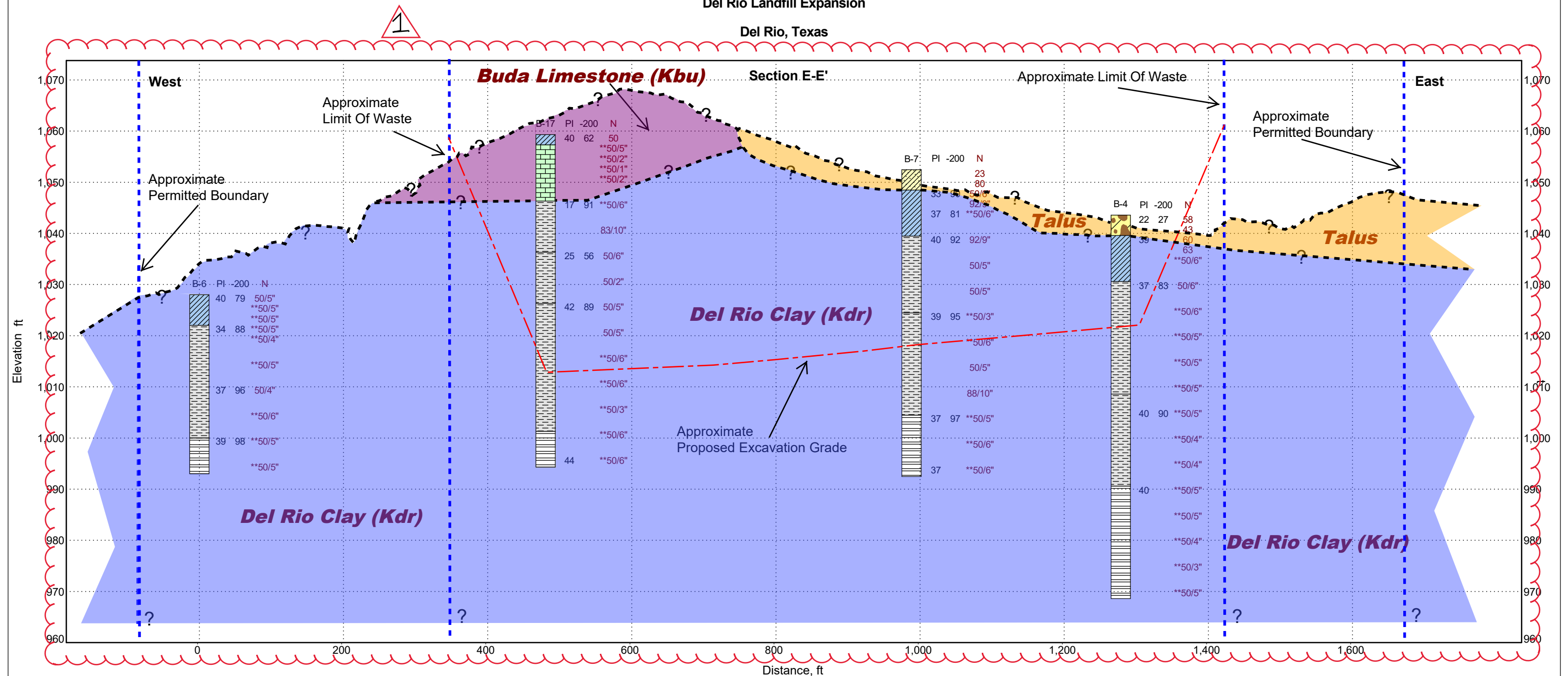

LEGEND:

- USCS Clayey Gravel
- USCS High Plasticity Clay
- Clay Shale
- Clay-Shale
- USCS Low Plasticity Sandy Clay
- Gravelly Fat Clay
- Limestone

NOTES:

The represented stratigraphy is based on the geotechnical engineer's interpretation of field and laboratory data. The depth where water was first encountered during drilling is depicted with an open triangle; the depth where water rose is depicted with a solid triangle. PI and -200 represent plasticity index and fines content for the sampled interval, with data shown at the top of interval indicated on the boring logs.

1 Revised Cross-section.



Project Mngr:	SKM	Project No.	
Drawn By:	MEB		2020-221
Checked By:	JRM	Scale:	AS SHOWN
Reviewed By:	SKM	Date:	11-19-2024

GENERALIZED STRATIGRAPHY

City of Del Rio Landfill Expansion Project

Del Rio, Val Verde County, Texas

Del Rio Landfill Expansion

Del Rio, Texas

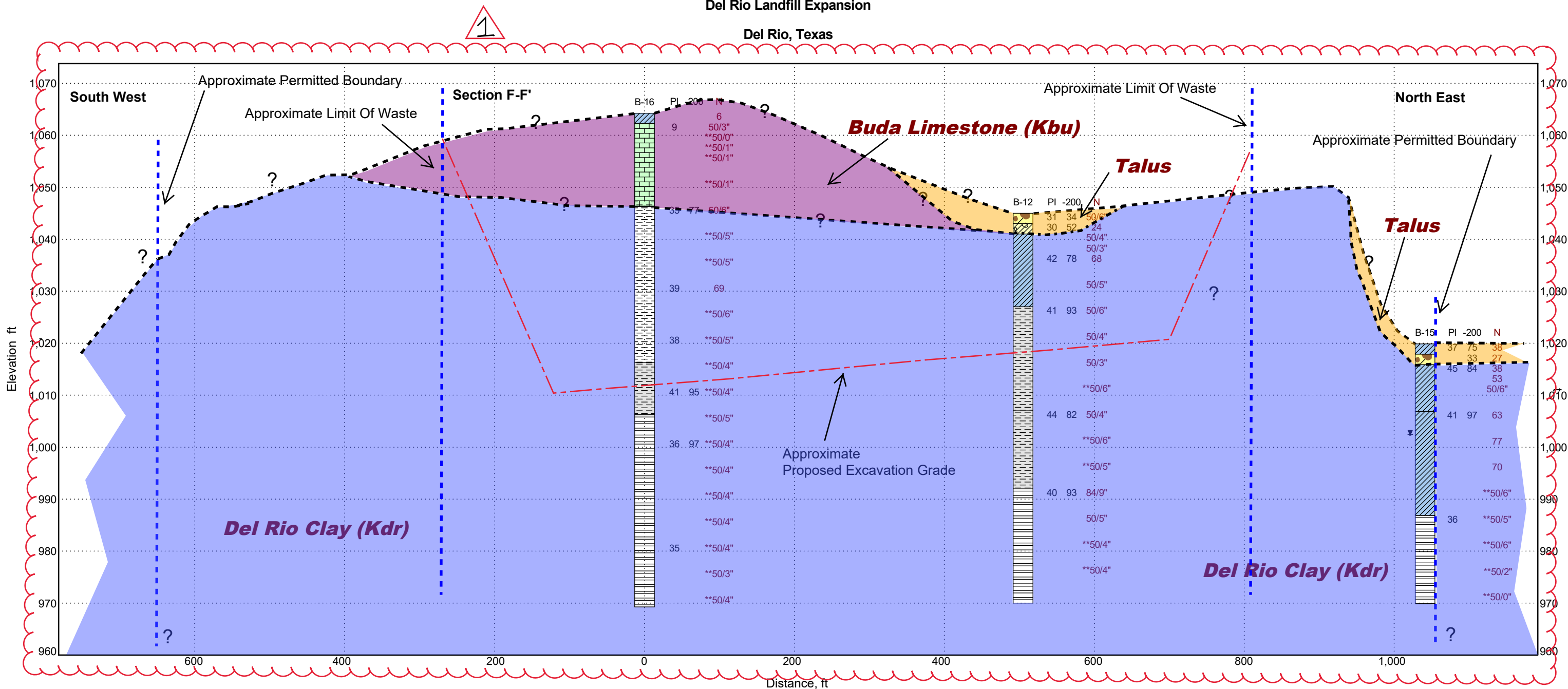

LEGEND:

- Clayey Gravel (GC)
- Gravelly Lean Clay (CL)
- Fat Clay (CH)
- Clay Shale
- Clay-Shale
- Gravelly Fat Clay (CH)
- Limestone

NOTES:

1 Revised Cross-section. The represented stratigraphy is based on the geotechnical engineer's interpretation of field and laboratory data. The depth where water was first encountered during drilling is depicted with an open triangle; the depth where water rose is depicted with a solid triangle. PI and -200 represent plasticity index and fines content for the sampled interval, with data shown at the top of interval indicated on the boring logs.



Project Mngr:	SKM	Project No.	
Drawn By:	MEB		2020-221
Checked By:	JRM	Scale:	AS SHOWN
Reviewed By:	SKM	Date:	11-19-2024

GENERALIZED STRATIGRAPHY

City of Del Rio Landfill Expansion Project

Del Rio, Val Verde County, Texas

Del Rio Landfill Expansion

Del Rio, Texas

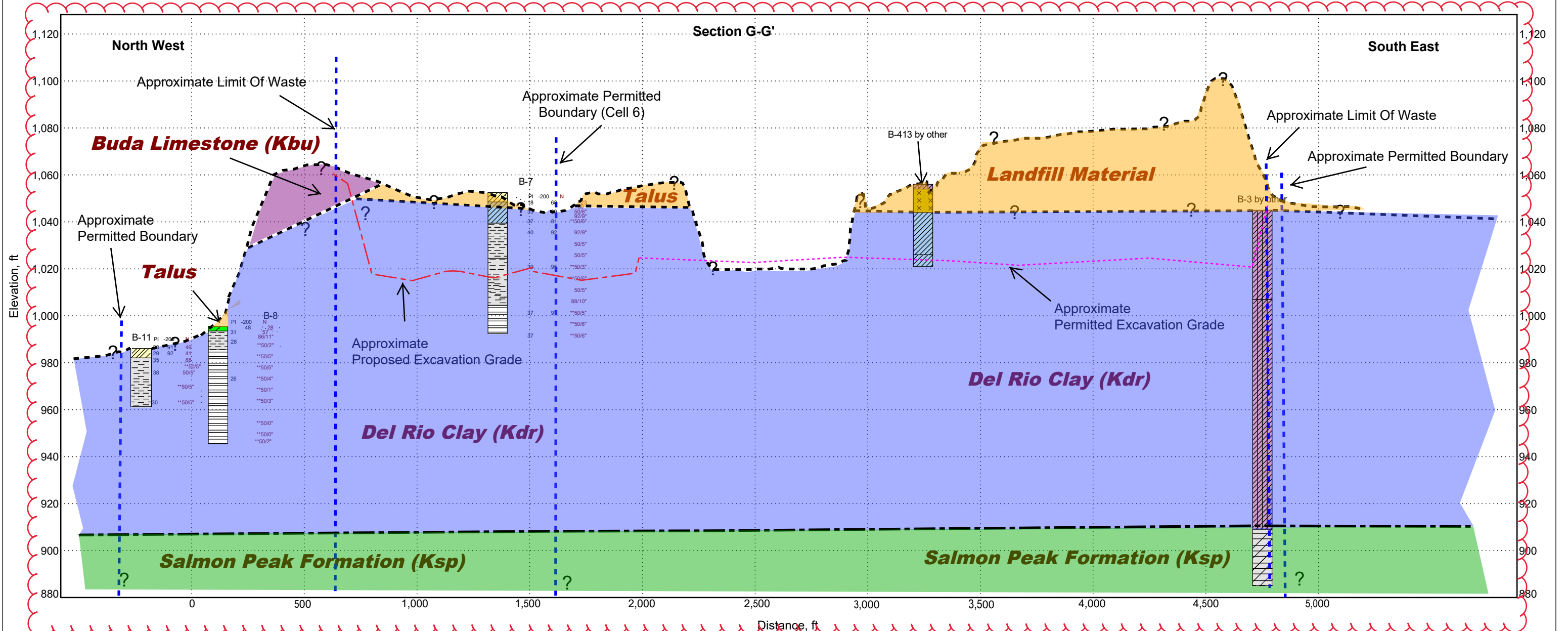

LEGEND:

- Silty Clay
- Clay Shale
- USCS Low Plasticity Sandy Clay
- USCS High Plasticity Clay
- Clay-Shale
- Marl
- USGS Clayey Sand
- USCS Low Plasticity Clay
- Clay and Caliche

Revised Cross-section.

NOTES:

The represented stratigraphy is based on the geotechnical engineer's interpretation of field and laboratory data. The depth where water was first encountered during drilling is depicted with an open triangle; the depth where water rose is depicted with a solid triangle. PI and -200 represent plasticity index and fines content for the sampled interval, with data shown at the top of interval indicated on the boring logs.

GENERALIZED STRATIGRAPHY

City of Del Rio Landfill Expansion Project

Del Rio, Val Verde County, Texas



Project Mngnr:	SKM	Project No.	
Drawn By:	MEB		2020-221
Checked By:	JRM	Scale:	AS SHOWN
Reviewed By:	SKM	Date:	11-19-2024

Del Rio Landfill Expansion

Del Rio, Texas

1

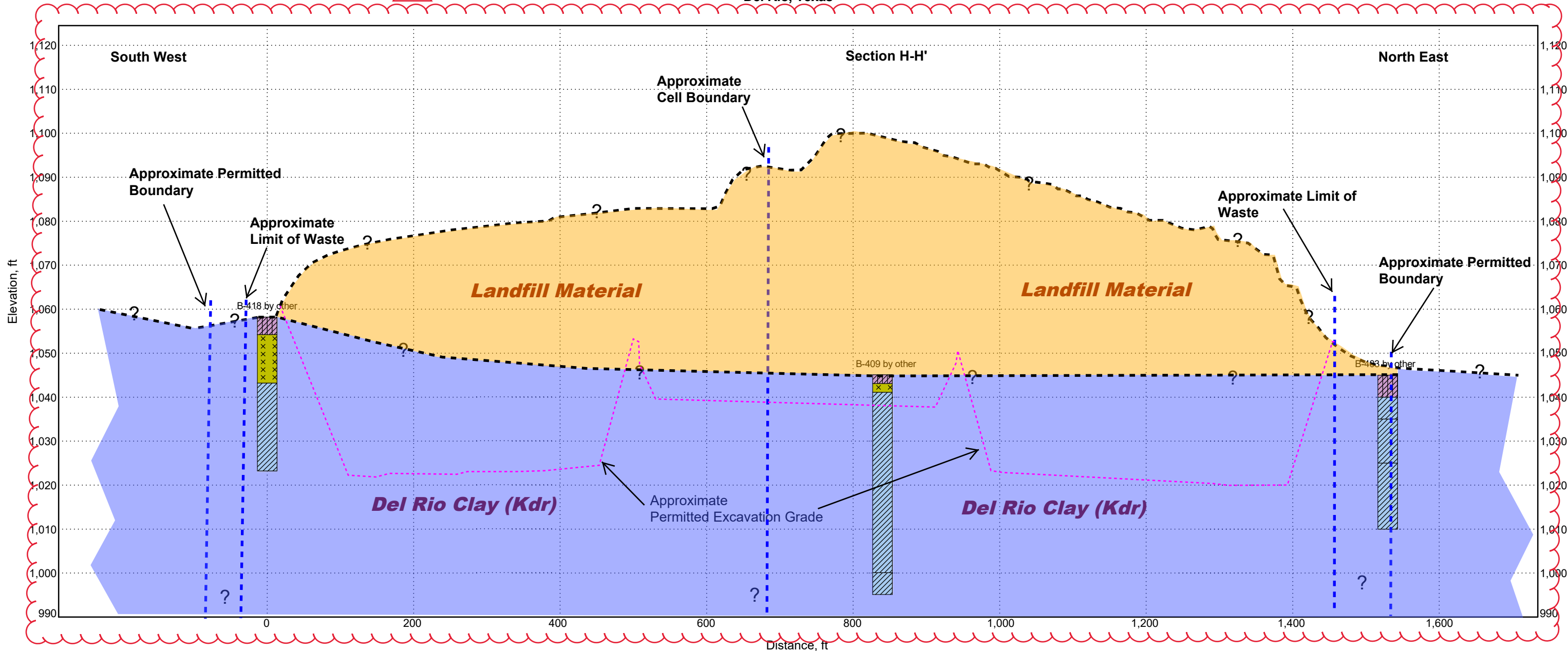

LEGEND:

- Silty Clay
- USCS High Plasticity Clay
- Clay and Caliche

Revised Cross-section.



Project Mngr:	SKM	Project No.	
Drawn By:	MEB		2020-221
Checked By:	JRM	Scale:	AS SHOWN
Reviewed By:	SKM	Date:	11-19-2024

GENERALIZED STRATIGRAPHY

City of Del Rio Landfill Expansion Project

Del Rio, Val Verde County, Texas

CITY OF DEL RIO LANDFILL

VAL VERDE COUNTY, TEXAS

TCEQ PERMIT NO. MSW-207C

MAJOR PERMIT AMENDMENT APPLICATION PART III – SITE DEVELOPMENT PLAN

APPENDIX IIIK

WASTE CONTAINMENT POINT OF COMPLIANCE

Prepared for
City of Del Rio

September 2023
Revision 1 August 2024
Revision 2 March 2025

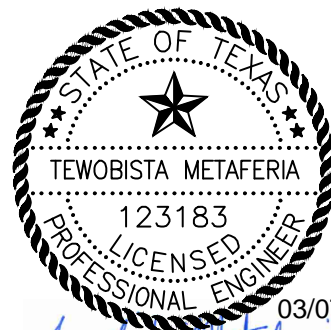

03/07/2025

Teowobista Metaferia

Prepared by
CP&Y an STV Company
TPBE Registration No. F-1741
13155 Noel Road, Suite 200
Dallas, TX 75240
214-638-0500

This document is intended for permitting purposes only.

TABLE OF CONTENTS

1.0	INTRODUCTION	IIIK-1
2.0	CONTAINMENT SYSTEM OVERVIEW	IIIK-1
3.0	LEACHATE QUALITY.....	IIIK-2
4.0	SITE GEOLOGY	IIIK-5
5.0	HYDROGEOLOGY AND GROUNDWATER CHARACTERISTICS	IIIK-6
5.1	Regional Aquifers.....	IIIK-6
5.2	Site Hydrogeology.....	IIIK-6
5.2.1	1986 and 1994 Groundwater Investigation	IIIK-6
5.2.2	Groundwater Investigation 2020	IIIK-7
5.3	Groundwater Waiver	IIIK-7
6.0	POINT OF COMPLIANCE DEMONSTRATION	IIIK-8
6.1	HELP Model Demonstration	IIIK-8
6.1.1	HELP Model	IIIK-8
6.1.2	HELP Model Input.....	IIIK-8
6.2	MULTIMED Model Demonstration	IIIK-8
6.2.1	Description of Model Input	IIIK-9
6.2.2	Sensitivity Analysis	IIIK-11
7.0	MODEL INPUT PARAMETERS	IIIK-13
8.0	RESULTS AND CONCLUSIONS.....	IIIK-14
Appendix IIIK-A.	LEACHATE GENERATION MODEL	
Appendix IIIK-B.	RAINFALL RECHARGE	
Appendix IIIK-C.	MULTIMED MODEL	



LIST OF TABLES

Table 3-1 – Typical Chemical Constituent Concentrations in Leachate.....	IIIK-3
Table 3-2 – Chemical Constituent MCLs and Del Rio LF Leachate Quality.....	IIIK-5
Table 6-1 – Landfill Conditions Modeled in HELP	IIIK-8
Table 6-2 – Chemical Specific Data	IIIK-10
Table 6-3 – Source Specific Data	IIIK-10
Table 6-4 – Aquifer Specific Data	IIIK-11
Table 6-5 – Sensitivity of Parameters to DAF.....	IIIK-12
Table 6-6 – Base Model Parameters	IIIK-13

LIST OF FIGURES

Figure IIIK.8-1 – Site Plan Point of Compliance.....	IIIK-15
--	---------

Table 3-1 – Typical Chemical Constituent Concentrations in Leachate MCLs and City of Del Rio LF Leachate Quality

Constituent	MCL Listed in §330.331(a)(1) (mg/l)	Leachate Quality Information Historically Used for POC Demonstrations in Texas (mg/l) ¹ City of Del Rio Landfill Leachate Quality Information (mg/l) ¹	Minimum Dilution Attenuation Factor
Arsenic	0.05	5.00 0.010	<u>100</u>
Barium	1.0	100.00 0.047	<u>100</u>
Benzene	0.005	0.814 0.001	<u>163</u>
Cadmium	0.01	1.00 0.005	<u>100</u>
Carbon tetrachloride	0.005	0.50 0.001	<u>100</u>
Chromium (hexavalent)	0.05	5.00 0.003	<u>100</u>
2,4-Dichlorophenoxy acetic acid	0.1	<u>10.0</u>	<u>100</u>
1,4-Dichlorobenzene	0.075	7.50 0.001	<u>100</u>
1,2-Dichloroethane	0.005	0.50 0.001	<u>100</u>
1,1-Dichloroethylene	0.007	0.70 0.001	<u>100</u>
Endrin	0.0002	0.050 0.00005	<u>250</u>
Fluoride	4	2.44	
Lindane	0.004	<u>0.4</u>	<u>100</u>
Lead	0.05	5.00 0.005	<u>100</u>
Mercury	0.002	0.20 0.002	<u>100</u> 1.00
Methoxychlor	0.1	0.00005	
Nitrate	10	0.2	
Selenium	0.01	1.00 0.010	<u>100</u> 1.00
Silver	0.05	5.00 0.010	<u>100</u>
Toxaphene	0.005	0.50 0.005	<u>100</u> 1.00
1,1,1-Trichloroethane	0.2	0.001	
Trichloroethylene	0.005	1.30 0.001	<u>260</u>
2,4,5-Trichlorophenoxy acetic acid	0.01	1.00 0.002	<u>100</u>
Vinyl Chloride	0.002	0.20 0.001	<u>100</u>

¹ [Estimated leachate concentration values reported from the Texas Water Commission Alternative Liner Design Handbook, August 1993](#) ~~Data was obtained from the leachate sampling was done in September 2021.~~

The second data used to calculate the DAF is the Del Rio Landfill leachate concentration. Table 3-2 lists the MCL's listed in 330.331(a)(1) and the site-specific leachate constituent levels. The leachate constituent's concentration for the Del Rio Landfill are at or below the MCL's set forth in 330.331(a)(1). The leachate sampling was done in 2021 and the results are included in Appendix IIIK-D.

Table 3-2 – Chemical Constituent MCLs and Del Rio LF Leachate Quality

Constituent	MCL Listed in §330.331(a)(1) (mg/l)	Del Rio Landfill Leachate Quality Information ¹ (mg/l)	Minimum Dilution Attenuation Factor
Arsenic	0.05	0.010	
Barium	1.0	0.047	
Benzene	0.005	0.001	
Cadmium	0.01	0.005	
Carbon tetrachloride	0.005	0.001	
Chromium (hexavalent)	0.05	0.003	
2,4-Dichlorophenoxy acetic acid	0.1		
1,4-Dichlorobenzene	0.075	0.001	
1,2-Dichloroethane	0.005	0.001	
1,1-Dichloroethylene	0.007	0.001	
Endrin	0.0002	0.00005	
Fluoride	4	2.44	
Lindane	0.004		
Lead	0.05	0.005	
Mercury	0.002	0.002	1.00
Methoxychlor	0.1	0.00005	
Nitrate	10	0.2	
Selenium	0.01	0.010	1.00
Silver	0.05	0.010	
Toxaphene	0.005	0.005	1.00
1,1,1-Trichloroethane	0.2	0.001	
Trichloroethylene	0.005	0.001	
2,4,5-Trichlorophenoxy acetic acid	0.01	0.002	
Vinyl Chloride	0.002	0.001	

¹ [Data was obtained from the leachate sampling was done in September 2021.](#)

4.0 SITE GEOLOGY

Multiple site investigations have been conducted at the City of Del Rio Landfill facility to characterize the subsurface conditions at the site. A summary of the borings from the previous and current site investigation is included in Appendix IIIJ.

5.2.2 Groundwater Investigation 2020

Arias Geoprosessionals , Inc. (Arias) installed seventeen (17) boring of which ten (10) were converted to piezometers in November 2020 on a 75-ac tract of land located adjacent to the landfill. During installation, water was encountered at three of the 10 piezometer locations as follows:

- B-1
- B-15
- B-13

No water was observed in the other seven (7) piezometers over the two-year monitoring period. Based on the analysis of the boring logs prepared by Arias, and taking the local topography into account, shallow groundwater encountered during the boring and sampling operations in borings B-1, B-15 and B-13 occurs in three distinct, vertically separated perched groundwater systems within the Del Rio Clay. Refer to Appendix IIIN Section 4.3 for additional information.

Generally speaking, the upper 80 feet of the subsurface tends to be fractured. This can be due to a combination of conditions such as shrinking and swelling of clay-rich formations, formation of desiccation cracks, and/or elastic behavior caused by erosion and removal overburden pressure over time. Fracturing provides a flow pathway for seepage from the surface to migrate downward into perched groundwater zones. The recharge to these perched groundwater systems occurs as the result of precipitation events and vertical seepage from the surface downward.

Groundwater flow in shallow groundwater systems closely mimics surface topography. Consequently, flow in each of the perched groundwater systems encountered at the site will generally be to the southwest where flow exits to the surface in Calaveras Creek. All three of the perched systems occur at elevations that are above the elevation of Calaveras Creek which is at an elevation of approximately 960 feet above mean sea level. Perched groundwater is found in porous saturated zones at an elevation that is higher than the local or regional groundwater table. The three perched zones identified for this project all occur within the Del Rio Confining Unit at elevations that are higher than the regional potentiometric surface of the Edwards Hydrologic Unit. All three zones daylight into the creek which supports the interpretation that these zones are perched.

5.3 Groundwater Waiver

The City is requesting to extend the groundwater waiver as part of this Major Permit Amendment Application. Refer to Appendix III [C Alternative Liner Design](#) ~~N for the No Migration Demonstration~~.

Appendix IIIK-A. LEACHATE GENERATION MODEL



LANDFILL PROFILE

The landfill profiles for various stages of the landfill development are presented in the attached HELP Model summary sheets. The profile presented below includes a clay liner with a standard Subtitle D final cover system.

Liner Systems

The Subtitle D clay liner designed for developed and undeveloped cells consists of a 24-inch-thick compacted clay liner with a hydraulic conductivity of 1×10^{-7} cm/s. Default soil characteristics from the HELP model were selected for the compacted clay liner.

OverLiner Systems

The overliner system consists of a GCL and 40-mil LLDPE geomembrane. The geomembrane liner was modeled for a good quality installation quality, 4 construction defects per acre, and a production pinhole density of 1 hole/acre. Default soil characteristic from the HELP Model were selected for the LLDPE geomembrane hydraulic conductivity.

Leachate Collection System

Developed Subtitle D Cells 1 through 5 were constructed with an LCS that includes a 200-mil thick single-sided geocomposite (floor grades).

Waste Layers

A default wilting point was selected from HELP to represent municipal solid waste. The waste layer was modeled with a hydraulic conductivity of 1×10^{-3} cm/s, which is the default HELP number for MSW. The moisture content, field capacity, and porosity values were selected as discussed previously.

Intermediate Cover

The intermediate cover consists of a 12-inch-thick layer of soil placed over the waste. Default soil characteristics were selected from HELP to represent the available onsite soils with a hydraulic conductivity of 6.4×10^{-5} cm/s.

Final Cover

The final cover over the Subtitle D and pre-Subtitle D areas consists of a 12-inch erosion layer with the top 6 inches capable of sustaining growth of vegetation and an 18-inch infiltration layer. The infiltration layer consists of compacted soil with a hydraulic conductivity of $1 \times 10^{-7.5}$ cm/s. [The site is modeled using \$1 \times 10^{-5}\$ hydraulic conductivity and provides a conservative design.](#)

CITY OF DEL RIO LANDFILL

VAL VERDE COUNTY, TEXAS

TCEQ PERMIT NO. MSW-207C

MAJOR PERMIT AMENDMENT APPLICATION PART III – SITE DEVELOPMENT

APPENDIX III GEOTECHNICAL REPORT

Prepared for
City of Del Rio

September 2023
[Revision 1 March 2025](#)



Prepared by
CP&Y an STV Company
TPBE Registration No. F-1741
13155 Noel Road, Suite 200
Dallas, TX 75240
214-638-0500

This document is intended for permitting purposes only.

TABLE OF CONTENTS

1.0	INTRODUCTION	IIIL-1
2.0	LABORATORY TESTING	IIIL-1
2.1	Introduction	IIIL-1
2.2	Classification Tests	IIIL-2
2.2.1	Material Strength Tests	IIIL-2
2.2.2	Coefficient of Permeability Tests	IIIL-2
2.2.3	Consolidation Tests	IIIL-2
2.2.4	Moisture-Density Relationships	IIIL-2
2.3	Conclusion of Laboratory Testing	IIIL-3
3.0	PROPERTIES OF SITE SOILS AND LANDFILL COMPONENTS.....	IIIL-3
3.1	General.....	IIIL-3
3.2	Generalized Site Stratigraphy	IIIL-3
3.2.1	Stratum I.....	IIIL-3
3.2.2	Stratum II.....	IIIL-3
3.2.3	Stratum III.....	IIIL-4
3.3	Material Requirements for Landfill Components	IIIL-4
4.0	CONSTRUCTION CONSIDERATIONS.....	IIIL-9
4.1	General.....	IIIL-9
4.2	Landfill Excavation	IIIL-9
4.3	Clay Liner Construction.....	IIIL-9
4.4	Drainage Materials.....	IIIL-10
4.5	Liner Protective Cover.....	IIIL-10
4.6	Operational Cover Soils.....	IIIL-11
4.7	Final Cover Construction.....	IIIL-11
4.7.1	Final Cover Infiltration Layer Construction	IIIL-11
4.7.2	Final Cover Erosion Layer Construction	IIIL-11
4.8	Perimeter Embankment Construction.....	IIIL-11
5.0	SLOPE STABILITY ANALYSIS.....	IIIL-12
5.1	General.....	IIIL-12
5.2	Section Selected for Analysis	IIIL-13
5.3	Configurations Analyzed	IIIL-13
5.4	Input Parameters	IIIL-13
5.5	Results of Stability Analysis.....	IIIL-15
6.0	SETTLEMENT, STRAIN, AND HEAVE ANALYSIS	IIIL-16
6.1	General.....	IIIL-16
6.2	Foundation Heave.....	IIIL-16
6.3	Foundation Settlement and Strain.....	IIIL-16



1.0 INTRODUCTION

This report presents the geotechnical analysis and design for the proposed major permit amendment concerning the vertical expansion of the Del Rio Landfill. The analysis is based on the geotechnical data collected from previous subsurface investigations at the site.

This report contains a compilation of geotechnical testing and design information, including:

- Slope stability analyses based on the geotechnical testing results and subsurface conditions including groundwater as well as landfill excavation and completion plans; and
- Settlement and heave analyses, which are also based on the landfill excavation and completion plans.

Additionally, the report provides geotechnical recommendations for the construction of landfill components, such as the bottom liner and the final cover system with a clay liner. Details regarding construction quality control, as well as material and construction specifications for the groundwater protection components, are outlined in Appendix IIID – Liner Quality Control Plan.

2.0 Laboratory Testing

2.1 Introduction

Previous geological investigations have been conducted at the Del Rio Landfill, including the sampling and geotechnical testing of materials collected during these studies. The following paragraphs provide a brief overview of the geological and geotechnical characteristics of the site. Further details on the geology and hydrogeology can be found in Appendix IIIJ – Geology Report of this application.

Three distinct geological subunits have been identified at the landfill, and for consistency with previous geological investigations, these units are numbered from the surface downward as Stratum I through Stratum III:

- Stratum I consists of silty clays with some sand and gravel.
- Stratum II consists of caliche and clay soils with some gravel content. Clay is the predominant constituent.
- Stratum III consists of clay and weathered shale, grading into unweathered shale, containing some limestones/siltstone seams, caliche, and gypsum. These soils comprise the Del Rio Clay formation.

Additional description of the above geological units is provided in Section 3.

Laboratory tests were conducted on select samples recovered from the borings drilled to evaluate the physical and engineering properties of the different strata. Laboratory tests were performed in accordance with ASTM procedures. Available laboratory testing results from the previous (1989) investigations completed by Raba-Kistner Consultants, Inc., (1994) Trinity Engineering Testing Corporation, and (2020) Arias & Associates, Inc are provided in Appendix IIIJ – Geology Report , and summarized in Tables 3-1, 3-2, and 3-3.

The laboratory testing meets the requirements of Title 30 TAC §330.63(e)(5)(A) regarding sampling each stratum. A summary of the laboratory tests performed is given in Table 2-1.

Table 2-1 Geotechnical Test Methods Performed

Test	Test Method
Sieve Analysis (Passing No. 200)	ASTM D 1140
Atterberg Limits (Liquid & Plastic Limit)	ASTM D 4318
Moisture Content	ASTM D 2216
Unconfined Compression	ASTM D 2166 & Pocket Penetrometer
Coefficient of Permeability (Hydraulic Conductivity)	Field Methods (vertical and horizontal permeability)
Consolidation	ASTM D 2435
Standard Proctor	ASTM D 698

2.2 Classification Tests

Classification tests consisting of Atterberg limits, percent passing the number 200 sieve, dry unit weight, and moisture content were performed on selected soil and shale samples recovered from boreholes. These test results are presented in Appendix IIIJ – Geology Report and are summarized in Tables 3-1, 3-2, and 3-3. Classification tests were used to classify the soils according to the Unified Soil Classification System (USCS) and to evaluate physical properties of the soils.

2.2.1 Material Strength Tests

Material strength tests were performed to provide general strength information and were used to evaluate the soils at the site. Unconfined compression tests were performed in the field using a hand penetrometer. Additional laboratory unconfined Compression tests (ASTM D 3080) were conducted for selected samples. Shear strength correlations for each layer were developed from correlating the field and laboratory test results. Additionally, extensive field penetrometer testing was performed during investigations, as documented on boring logs included in Appendix IIIJ – Geology Report and summarized in Table 3-1, 3-2, and 3-3. The results of field penetrometer testing were used to develop total and effective stress parameters required for stability analysis of the landfill and foundation strata.

2.2.2 Coefficient of Permeability Tests

Field slug and falling head tests were performed in the field to evaluate the hydrogeological properties of the soils and shale at the site, as well as laboratory tests that were performed of samples collected during investigations. These tests were performed to assist in evaluation of the hydrogeologic properties of the geological units at the site. The results of permeability testing performed in the field and laboratory are presented in Appendix IIIJ – Geology Report of this application and in Tables 3-1, 3-2, and 3-3.

2.2.3 Consolidation Tests

Consolidation testing was performed in the laboratory on representative soil samples obtained during field investigations. The results of the consolidation testing were utilized in settlement and heave analyses performed for this application.

2.2.4 Moisture-Density Relationships

Standard Proctor laboratory compaction tests were performed during previous liner construction activities at the site. The tests were performed to evaluate the moisture-density relationship of the

materials. Remolded samples for coefficient of permeability tests were compacted by static loading the sample to approximately 95 percent of the Standard Proctor maximum dry density at approximately the optimum moisture content determined from the Proctor test. The results to date demonstrate that the clays on site are suitable for liner construction, and able to achieve the 1×10^{-7} cm/sec permeability criteria. Sufficient soil quantities suitable for liner and final cover construction is available on-site, although alternatively clayey soils may be imported from off-site borrow areas.

2.3 Conclusion of Laboratory Testing

Classification testing along with unit weight, moisture content, and sieve analysis results were used to support field observations during subsurface explorations. Testing results were also used to support the subsurface characterization which includes the three formations that exist generally across the site. Additionally, soil strength parameters from both field and laboratory were conservatively generalized and selected for use in the geotechnical stability analysis. Finally, consolidation testing on representative samples obtained during field investigations were used to perform settlement and heave analyses for this application.

3.0 PROPERTIES OF SITE SOILS AND LANDFILL COMPONENTS

3.1 General

This section of the report includes the generalized stratigraphy for the site, typical properties of subsurface soils, potential uses of materials that may be excavated during construction, and soil material requirements for various components of the landfill. The laboratory test results for soil samples obtained from the site are summarized in Tables 3-1, 3-2, and 3-3. Refer to Appendix IIIJ for the results of the geotechnical testing performed on the site soils.

3.2 Generalized Site Stratigraphy

The subsurface materials encountered at the site are discussed in detail in the Appendix J – Geology Report. In general, the subsurface at the site is characterized by three units. The principal geologic formation at the site is the Del Rio Clay Formation. It is overlain in some portions of the site by residual soils and remnants of the overlying Buda Limestone, and by secondary “caliche” soil and/or harder caliche layers. The specific soil stratigraphy can be divided into three generalized soil zones.

3.2.1 Stratum I

Stratum I consists of silty clays with some sand and gravel. This layer is a “topsoil” zone and likely is a residual soil intermixed with erosional remnants of the overlying Buda Limestone. This layer is very thin (1.5 to 4.5 feet) and absent in some areas of the site.

3.2.2 Stratum II

Stratum II consists of caliche and clay soils with some gravel content. Clay is the predominant constituent. The caliche is a cementitious material, primarily calcium carbonate, and is intermixed with the soil or as thin hard interbedded layers. This layer is also fairly thin (2.0 to 11.0 feet) and absent in some areas of the site.

3.2.3 Stratum III

Stratum III consists of clay and weathered shale, grading into unweathered shale, containing some limestones/siltstone seams, caliche, and gypsum. These soils comprise the Del Rio Clay formation.

3.3 Material Requirements for Landfill Components

Construction of the landfill will require clay or clayey soils which can be compacted to have an in-place hydraulic conductivity of 1×10^{-7} cm/s or less for the soil liner and an in-place hydraulic conductivity of 1×10^{-7} cm/s for the soil infiltration layer of the composite final cover system.

Soil will also be required for protective cover on the liner, operational cover (daily cover, intermediate cover) the infiltration and erosion layer components of the composite final cover, berm construction, and other miscellaneous general fill. Granular material (i.e., gravel) will be used for the leachate collection sumps, leachate collection chimney drains and may be used for groundwater dewatering collection trenches. Typical material requirements for various soil structures are summarized in Table 3-4.

Testing requirements and construction quality control and quality assurance for liner soils are detailed in Appendix IIID - Liner Quality Control Plan. Testing requirements and construction quality control and quality assurance for final cover soils are detailed in Appendix IIIE - Closure Plan and in Appendix IIIE-A - Final Cover System Quality Control Plan. Liner and final cover details are presented in Appendix IIIA-A - Liner and Final Cover System Details.

Table 3-1 Summary of Stratum I - Existing Geotechnical Data

Boring No.	Depth (ft-bgs)	LL	PI	Passing #200 sieve (%)	Moisture Content (%)	Dry Weight (pcf)	Horiz. Perm. (cm/sec)	Vertical Perm. (cm/sec)
Stratum I – Raba-Kisther Consultants, Inc. (1989)								
B-401	15	68	20.5	92.1	15	110.9	5.2E-09	N/A
B-402	1.5	49	20.5	95.3	17	109		N/A
B-403	6	72	20.5	91.7	20.5	105.9		N/A
B-404	N/A							
B-405	0.5	34	20	42.1	5	121.4		N/A
B-406	N/A							
B-407	6	55	19.5	82	19.5	106.7		N/A
B-408	N/A							
B-409	N/A							
B-410	N/A							
B-411	0.5	58.5	22.5	93.6	20.5	105.9		N/A
B-412	8.5	59	20.5	95	12	113.8		N/A
B-413	N/A							
B-414	N/A							
B-415	N/A							
B-416	1	39.5	21	93.1	11	114.9		N/A
B-417	N/A							
B-418	N/A							
B-419	N/A							
B-420	N/A							
B-3	4.5	39.5	18.5	85	8	118.1		N/A
Stratum I – Trinity Engineering Testing Corp (1994)								
B-1	5	54	38	95	11	118		1.9E-09
B-2	1	N/A	N/A	N/A	25	98		N/A
B-3	N/A							
B-4	N/A							
Stratum I – Arias and Associates, Inc (2020)								
B-1	2	53	35	67	9			
B-2	N/A							
B-3	N/A							
B-4	4	39	22	27	2			
B-5	4	42	24	68	6			
B-6	N/A							
B-7	4	37	18	68	5			
B-8	2	45	28	48	2			
B-9	N/A							
B-10	N/A							
B-11	N/A							
B-12	2	49	31	34	4			
B-13	2	36	19	74	4			
B-14	N/A							
B-15	4	58	37	75	7			
B-16	N/A							
B-17	2	61	40	62	4			
COMPUTATIONS – Stratum I								
Mean		49.9	25.0	73.0	10.4	111.1	5.20E-09	1.90E-09
Minimum		34	18	27	2	98	5.2E-09	1.9E-09
Maximum		72	40	95.3	25	121.4	5.2E-09	1.9E-09
Standard Deviation		11.2	7.4	21.9	7.0	6.9	N/A	N/A
Number of Tests		19	19	19	20	11	1	1

Table 3-2 Summary of Stratum II - Existing Geotechnical Data

Boring No.	Depth (ft-bgs)	LL	PI	Passing #200 sieve (%)	Moisture Content (%)	Dry Weight (pcf)	Horiz. Perm. (cm/sec)	Vertical Perm. (cm/sec)
Stratum II – Raba-Kisther Consultants, Inc. (1989)								
B-401	N/A							
B-402	N/A							
B-403	N/A							
B-404	25.1	77	21	92.6	19.5	106.7	N/A	N/A
B-405	20.5	69	21.5	96.6	19	107.1	N/A	N/A
B-406	25.1	60.5	19.5	96.7	14.5	111.4	N/A	N/A
B-407	20.5	69.5	20	95.5	15	110.9	2.1E-09	N/A
B-408	N/A							
B-409	15.5	62	20	82.1	16	109.9	N/A	1.6E-09
B-410	20.5	69.5	21.5	93.4	16.5	109.4	N/A	N/A
B-411	10.5	75.5	22.5	97.5	22.5	104.1	2.1E-09	N/A
B-412	15.5	68	23	95.6	19.5	106.7	4E-08	N/A
B-413	N/A							
B-414	15.5	78	23	97.5	19.5	106.7	N/A	N/A
B-415	N/A							
B-416	N/A							
B-417	15.5	64.5	21.5	95.2	10.5	115.4	3.5E-09	N/A
B-418	10.5	51.5	19.5	78.2	12.5	113.3	N/A	N/A
B-419	N/A							
B-420	N/A							
B-3	9.5	51.5	19	86	12.5	113.3	N/A	N/A
Stratum II – Trinity Engineering Testing Corp (1994)								
B-1	10	57	40	95	15	116	2.7E-09	N/A
B-2	20.5	57	38	97	18	114	N/A	N/A
B-3	10	N/A	N/A	N/A	13	118	N/A	N/A
B-4	15	N/A	N/A	N/A	15	118	N/A	N/A
Stratum II – Arias and Associates, Inc (2020)								
B-1	6	55	36	95	13			
B-2	N/A							
B-3	4	37	21	82	4			
B-4	13	57	37	83	9			
B-5	13	63	42	77	11	104.7	6.5E-07	
B-6	6	61	40	79	9			
B-7	13	56	37	81	9			
B-8	N/A							
B-9	N/A							
B-10	2	54	35	62	4			
B-11	N/A							
B-12	4	48	30	52	6			
B-13	N/A							
B-14	2	57	35	96	12			
B-15	13	67	45	84	11			
B-16	18	53	35	77	11			
B-17	N/A							
COMPUTATIONS – Stratum II								
Mean		60.7	28.9	86.7	13.2	110.9	1.16E-07	1.60E-09
Minimum		37	19	52	4	104.1	2.10E-09	1.60E-09
Maximum		78	45	97.5	22.5	118	6.47E-07	1.60E-09
Standard Deviation		9.6	8.9	11.7	4.8	4.5	2.60E-07	N/A
Number of Tests		25	25	25	27	17	6	1

Table 3-3 Summary of Stratum III - Existing Geotechnical Data

Boring No.	Depth (ft-bgs)	LL	PI	Passing #200 sieve (%)	Moisture Content (%)	Dry Weight (pcf)	Horiz. Perm. (cm/sec)	Vertical Perm. (cm/sec)
Stratum III – Raba-Kisther Consultants, Inc. (1989)								
B-401	42.5	N/A	N/A	95.4	18.5	107.6	N/A	3.3E-10
B-402	25.5	63	20	91.6	15	110.9	N/A	5.6E-10
B-403	23.5	62	20	89.6	18.5	107.6	N/A	N/A
B-404	N/A							
B-405	45.5	61.5	20.5	97.1	15	110.9	N/A	N/A
B-406	N/A							
B-407	N/A							
B-408	N/A							
B-409	26	69	20.5	90	18.5	107.6	N/A	1.4E-09
B-410	N/A							
B-411	49.5	65	22	98.2	18.5	107.6	N/A	N/A
B-412	N/A							
B-413	N/A							
B-414	35.5	40.5	20	89.8	10.5	115.4	N/A	7.4E-09
B-415	N/A							
B-416	N/A							
B-417	N/A							
B-418	N/A							
B-419	25.5	68	23.5	99.2	19.5	106.7	N/A	N/A
B-420	25.5	59.5	21	84.3	13	112.8	N/A	N/A
B-3	N/A							
Stratum III – Trinity Engineering Testing Corp (1994)								
B-1	15	N/A	N/A	N/A	18	117	1.9E-09	N/A
B-2	30	67	43	97	18	102.8	2.7E-09	N/A
B-3	29.5	75	52	98	17	109	2.9E-09	N/A
B-3A	49.5	68	44	96	15	116.4	1.7E-09	N/A
B-4	30	62	41	98	15	118	N/A	N/A
B-4A	55	57	37	97	14	116	2.9E-09	N/A
Stratum III – Arias and Associates, Inc (2020)								
B-1	35	45	28	85	10			
B-2	N/A	54	32	88	11			
B-3	90	61	41	87	12			
B-4	75	62	40	90	14			
B-5	55	62	42	74	14			
B-6	35	60	37	96	14	105.9	1.16E-08	
B-7	60	57	37	97	13			
B-8	50	43	26		8			
B-9	40	60	38	92	12			
B-10	45	61	40	93	12			
B-11	25	46	29	92	8			
B-12	75	61	40	93	13			
B-13	65	39	22	66	8			
B-14	30	55	34	97	12			
B-15	50	62	41	97	16	92.1	1.32E-08	
B-16	95	57	36	97	12			
B-17	65	64	42	89	13			
COMPUTATIONS – Stratum III								
Mean		58.9	33.0	91.8	13.9	109.7	5.27E-09	2.42E-09
Minimum		39	20	66	8	92.1	1.70E-09	3.30E-10
Maximum		75	52	99.2	19.5	118	1.32E-08	7.40E-09
Standard Deviation		8.6	9.4	7.3	3.3	6.4	4.91E-09	3.35E-09
Number of Tests		30	30	30	32	17	7	4

Table 3-4 Typical Soil Requirements for Landfill Construction

Landfill Component	Soil Description	Classification	Test Parameters				Material Source
			LL	PI	% - 200	Coefficient of Permeability CM/s	
Soil Liner	clayey sand, sandy clay, or clay	SC, CL, CH	30 min	15 min	30 min	1x10 ⁻⁷ max	On site ¹
Final Cover infiltration Layer	clayey sand, sandy clay, or clay	SC, CL, CH	30 min	15 min	30 min	1x10 ⁻⁷ max	On site
Liner Protective Cover	sand or sand with silt and clay	SP-SM, SP, SP-SC, SW, SME OR SM-SC				1x10 ⁻⁴ max	On site ³
Final Cover Erosion Layer	clayey sand, sandy clay, or clay	SC, CL, SM	Suitable to support plant growth				On site
Operational Cover (Daily Cover and Intermediate Cover)	sand, clayey sand, sandy clay, or clay	SP, SC, CL, CH	(2)	(2)	(2)	(2)	On site
Earth Fill	clayey sand, sandy clay, or clay	SC, CL, CH	--	--	--	--	On site
Perimeter Berm and Subgrade Preparation							

¹ If onsite materials meeting the required properties do not exist, an off-site material source can be used for liner soil.

² Refer to Section 4 for material requirements for the various final cover components.

³ If onsite material does not meet the hydraulic conductivity criteria, leachate collection chimney drains will be extended through the protective cover at selected locations and will be exposed adequately for transmission of leachate to the collection system.

4.0 CONSTRUCTION CONSIDERATIONS

4.1 General

This section contains recommendations for excavation of the landfill, and soil liner, leachate collection layer, and final cover materials and construction. Additionally, operational cover soils, final cover construction, and perimeter embankment construction related recommendations are included in this section.

The existing permitted area, covering Cells 1 through 6, has been fully constructed. The expansion will extend the current 105.6-acre permit boundary by 75.0 acres, bringing the total to 180.6 acres. The waste limit will increase by 31.3 acres, expanding from approximately 79.0 acres to approximately 110.3 acres. Cells 7 through 10 have been designed within this expanded waste limit of waste and will be constructed using the same liner system as the permitted cells.

4.2 Landfill Excavation

The landfill base grades for cells will be founded primarily in the Stratum III. The excavation for the liner construction will be performed in a manner that will achieve reasonable segregation of liner quality material from soils that are not suitable for a liner. Soil materials to be used for liner construction will be stockpiled separately, according to construction material properties outlined in Section 3 and visual observation during excavation.

Excavation of the soils encountered will be achieved with equipment such as excavators. Blasting of hard rock will not be required and will not be used at this site.

Excavation side slopes will be graded no steeper than 3 horizontal to 1 vertical. Excavation cut slopes around the perimeter of future cells may require erosion protection if an extended period of time occurs between excavation and liner construction. Interim erosion protection can be accomplished by diverting runoff away from the slopes. "Track walking" with a bulldozer up and down the slopes will create the effect of "mini-dikes" with the bulldozer tracks, which will reduce erosion.

Prior to beginning construction of the liner components, the subgrade area will be stripped to a depth sufficient to remove all loose surface soils or soft zones within the exposed excavation. The liner base grades will be proof-rolled with heavy, rubber-tired construction equipment or equivalent to detect soft areas. Soft areas will be undercut to firm material and backfilled with suitable compacted clay fill, as discussed in Section 2 of Appendix IIID – Liner Quality Control Plan. Preparation of the liner base grades will result in a surface that is stable and that does not exhibit significant rutting from the construction traffic. The prepared liner base grades will be approved by a Professional of Record (POR), tested to verify that it meets the requirements outlined in Section 4.3, and surveyed to verify grades.

4.3 Clay Liner Construction

The bottom and sides of the landfill excavation consists of 2-foot-thick compacted clay liner. The clay liner will have a maximum hydraulic conductivity of 1×10^{-7} cm/s. Details for the liner system are provided in Appendix IIIA– Landfill Unit Design Information (Appendix IIIA-A). Adequate soil liner material will be available from proposed landfill excavations, onsite, or offsite borrow sources to provide material for the liner construction. Preconstruction laboratory tests may be performed to verify that a borrow source soil material is adequate to meet the compacted clay liner requirements listed in Title 30 TAC §330.339(c)(5) prior to using any soil borrow source as liner.

The soils used for liner construction will have the minimum soil property values listed in Table 4-1 that will be verified by preconstruction testing in a soils laboratory. The following soil liner properties are included in Appendix IIID.

Table 4-1 Soil Liner Properties

Test	Specifications
Hydraulic Conductivity of Remolded Soils ¹	1.0 x 10 ⁻⁷ cm/s or less
Plasticity Index	15 minimum
Liquid Limit	30 minimum
Percent Passing No. 200 Mesh Sieve	30 minimum
Percent Passing 1-inch Sieve	100

¹A hydraulic conductivity test will be performed on soil samples remolded per ASTM D 698 in accordance with Appendix IIID.

Representative preliminary sampling will be performed on the materials that will be used for soil liner construction. Laboratory tests of samples recovered from soil borings indicate that some soils which will achieve a coefficient of permeability of less than 1x10⁻⁷ cm/s exist at the site. Prior to construction of each new liner area, conformance tests that include liquid limit, plastic limit, percent passing the No. 200 sieve, Standard Proctor (ASTM D 698) and remolded hydraulic conductivity tests will be performed for the soils used for liner. Additional conformance tests will be conducted if there are visual changes in the borrow material or the liquid limit or plasticity index vary by more than 10 points. The soil liner construction and testing procedures are outlined in Appendix IIID.

4.4 Drainage Materials

The Leachate Collection System (LCS) drainage material will consist of a drainage geocomposite over the entire liner bottom and side slopes. Each sector will have a bottom slope toward an LCS trench (i.e., pipe enveloped in gravel and geotextile) that will collect leachate from the bottom and sideslopes. The leachate collection system details are illustrated in Appendix IIIA– Landfill Unit Design Information (Appendix IIIA-A). The material specifications and construction procedures for the LCS components are presented in Appendix IIID - LQCP. The LCS design and demonstrations are provided in Appendix IIIC - Leachate and Contaminated Water Management Plan.

4.5 Liner Protective Cover

The liner protective cover is required to be a minimum of 24 inches thick for the sideslopes and the floor area. The purpose of the protective cover is to protect the drainage geocomposite from solid waste placed over the liner system. To ensure passage of leachate into the LCS, drainage passages (chimney drains) will be constructed through the protective cover. The chimney drains will be installed over the LCS collection pipes as shown in Appendix IIIA– Landfill Unit Design Information (Appendix IIIA-A). The protective cover will be placed with construction equipment in one lift such that it covers the leachate collection layer completely. The protective cover material will be free of solid waste and will not require compaction under the density-controlled construction procedures.

4.6 Operational Cover Soils

Operational cover soils include daily cover (placed over the waste each day) and intermediate cover (placed over waste in areas that will not receive additional fill for at least 6 months). All soils excavated at the site may be used for operational cover.

4.7 Final Cover Construction

4.7.1 Final Cover Infiltration Layer Construction

The infiltration layer of the final cover system will be constructed with clayey material and will be a minimum of 18 inches thick. As specified in Appendix III E – Closure Plan, the infiltration layer will consist of 18 inches of earthen material with a coefficient of permeability equal to or less than 1×10^{-7} cm/s. The purpose of this layer is to reduce infiltration of surface water into the fill. The final cover components material and construction requirements will be in accordance with Appendix III E-A.

4.7.2 Final Cover Erosion Layer Construction

As shown in Appendix III A-A, the final cover system will include a 12-inch-thick erosion layer for the top slope and a 24-inch thick erosion layer for the sideslopes. The erosion layer will protect the infiltration layer and will support vegetative growth. The top 6 inches of the erosion layer will consist of (1) topsoil stockpiled during the excavation process, (2) other on-site excavated soils amended as necessary to be capable of sustaining vegetation, and/or (3) imported soil materials. Whether placed in a single lift or two lifts, the erosion layer (top of final cover) will be selected to sustain vegetative growth.

4.8 Perimeter Embankment Construction

Perimeter embankments (berms) will be constructed as needed to prevent surface water flow from entering the landfill excavation. The embankment will have side slopes no steeper than 3 horizontal to 1 vertical (3H:1V). A sufficient amount of soil is available from the landfill excavations to construct the perimeter embankment and other features that require stable soil fill material.

The embankments will be constructed of onsite soils free of organic or other objectionable materials. Prior to beginning embankment fill, the subgrade area will be stripped to a depth sufficient to remove all topsoil and vegetation. Topsoil will be stockpiled for later use. The subgrade area will be proof-rolled with heavy, rubber-tired construction equipment to detect soft areas. Soft areas will be undercut to firm material and backfilled with suitable compacted clay fill. The subgrade preparation will result in a subgrade surface that is stable and does not exhibit significant rutting from construction equipment traffic. As necessary, the outside slope of all embankment construction above ground level will be vegetated to minimize erosion and desiccation.

The general fill placed below the liner (e.g., over excavated areas within the liner construction area) will be spread in maximum 8-inch-thick, loose, horizontal lifts and compacted to a minimum of 95 percent of maximum Standard Proctor dry density within a range of moisture content provided at or above 95 percent compaction as determined by Standard Proctor. A minimum of one Standard Proctor test (ASTM D 698) will be performed on each representative soil used as clay fill material. Each lift will receive a minimum of four passes with a heavy tamping roller unless adequate compaction can be demonstrated with fewer passes. Moisture-density field-testing and full-time third party construction quality assurance monitoring during construction will be performed in accordance with Appendix III D.

5.0 SLOPE STABILITY ANALYSIS

5.1 General

This slope stability analysis has been developed to analyze excavation slope and landfill completion slopes using critical sections for each condition. Slide2 was used to analyze the stability of excavation slopes and the final configuration of the site. Slide is an industry standard computer program developed by Rocscience Inc. and has been used widely in several slope stability application for dams, embankments, excavations, retaining walls and soil slopes.

The input file for the program includes:

- Slope surface geometry.
- Subsurface information to identify different types of soil materials in horizontal and vertical directions so that each subsurface segment is identified with corresponding soil strength parameters.
- Groundwater information. The program is capable of modeling multiple groundwater surfaces that may be applicable to various subsurface soil components identified in the second bullet.
- Material strength information. Each soil section (horizontal or vertical) identified in the second bullet is assigned with strength parameters including cohesion and friction angle.
- Model control and simulation user interface of the model that allows selection of the method of analysis (e.g., Simplified Bishop) and identifying simulation control parameters.

Automatic failure surface generation functions, that use either initiation/termination ranges of the failure surface or use search boxes to define failure surface location, are used to locate the critical failure surface. The two methods employed for this slope stability analysis are described below.

- Simplified Janbu Method - This method uses the method of slices to determine the stability of the mass above a failure surface.
- Simplified Bishop Method - This method uses the method of slices to discretize the soil mass for determining the factor of safety.

In general, the stability of various worst case critical sections were analyzed under static condition for short-term (construction) and long-term (after construction) safety. The slope stability analyses are provided in Appendix III-L-A.

The stability analysis has been conducted by demonstrating that, for each analyzed section, the forces resisting slope movement are greater than those potentially causing movement. The ratio of forces resisting movement to those creating movement is referred to as the factor of safety (FS). A slope is considered stable when the FS is equal to or greater than 1.0. For slope stability, an FS greater than 1.0 is preferred.

To account for increased uncertainty in the system, the FS value is adjusted accordingly. A factor of safety of 1.5 is applied to slopes expected to remain stable over the long term, including both excavation and final cover configurations. An FS of 1.3 is considered acceptable for total stress conditions that are temporary. Section Selected for Analysis

Slope stability analyses were conducted on the worst-case critical sections to assess the stability of the excavation, overliner, and the final cover configuration slopes. The slope geometries analyzed were derived from a review of the proposed excavation and the proposed final contour plan. Evaluation locations were chosen to focus on worst case critical slopes, including profiles that encompass the landfill configuration and natural materials at the toe and beneath the landfill excavation.

5.2 Configurations Analyzed

The excavation, overliner, and final landfill configurations were modeled to reflect worst case critical slope conditions, and the analysis was conducted using both circular and block failure surfaces. The maximum final fill slopes will be 4 horizontal to 1 vertical (4H:1V), while excavation slopes will be 3H:1V. A copy of the top-of-liner plan and final completion plan, which show the locations of the selected cross sections for analysis, can be found in Appendix III-L-A. Additionally, the configurations analyzed are illustrated graphically in Appendix III-L-A.

It is assumed that the horizontal length of an interim slope will not exceed that of the final cover condition. Should the horizontal length of an actual interim slope be greater than that of the final cover during site operations, an additional analysis will be performed if deemed necessary by a registered engineer, and the results will be maintained in the Site Operating Record.

5.3 Input Parameters

The soil parameters were selected based on a review of the boring logs and laboratory test results from the subsurface investigation studies at the site, along with engineering judgment and experience with similar materials. To ensure representative properties for the various soil groups, the unit weight for Stratum II and III used in the model is based on the average unit weight for each stratum, as outlined in Tables 3-1, 3-2, and 3-3. Since groundwater is not present at the site, no groundwater surface is modeled.

Table 5-1 summarizes the unit weights and strength parameters used in the stability analyses for the evaluated landfill slopes, including excavation, overliner, and final cover slopes. The selected strength parameters for both the liner and final cover systems are based on industry standards and are representative of the material properties that will be utilized during construction. These parameters will be verified during prior to construction.

5.4 Infinite Slope Stability Analysis

The infinite slope stability analysis for the liner and final cover system is detailed in Appendix III-L-A. This analysis covers the stability of the anchor trench design, the stability of cover and drainage materials placed on anchored geosynthetics, and the shear forces within the liner system. Additionally, the final cover slope stability analysis specifically addresses the shear forces within the final cover system.

As demonstrated in the calculations presented in Appendix III-L-A, both the liner and final cover systems are structurally stable when using industry-standard strength parameters. These parameters will be verified during the construction. Prior to the construction liner, overliner, and/or final cover, the POR will perform interface strength testing with the actual materials that will be used during.

Table 5-1 Summary of Material Weight and Strength Parameters Used in the Slope Stability Analysis

Strength Parameters			Comments
Liner System			<p>For The liner system includes a 2-foot-thick compacted clay layer, drainage geocomposite (single-sided on floor grades and double-sided on 3H:IV sideslopes), and a 2-foot-thick protective cover soil layer. This system is modeled as two layers for the global stability analysis: the 2-foot-thick compacted clay liner and the soil protective cover.</p> <p>For the rotational global stability analysis, the liner system is modeled as two layers: the compacted clay liner and the soil protective cover layer. The drainage geocomposite layer is not included in the global analysis because it provides a negligible contribution to the forces that are resisting movement. The strength values selected for the liner system represent strength values typically used in the industry and these same strength values have been used in various permit applications approved by TCEQ. Duncan and Wright (2005) provide a comprehensive discussion regarding strength parameters for a liner system. In Chapter 5 - Shear Strengths of Soil and Municipal Solid Waste, a significant amount of data are presented and evaluated for compacted clay liners. The results indicate that the lowest cohesion value for compacted cohesive soils is 9 kPa (187 lb/ft²) and the lowest reported friction angle value is 19 degrees. Therefore, selected values of 100 lb/ft² for cohesion and 16 degrees of friction angle conservatively represent the liner system. Soil properties used in the slope stability analysis are subject to verification at the time of each liner construction. Appendix IIID - LQCP includes the material strength tests required for soil used for liner construction. Protective cover and compacted clay liner soil unit weight values are based on experience with liner system construction. The global stability analysis is included in Appendices IIIL-A.</p>
Soil Material Strength Parameters			
Cohesion (lb/ft²)	Friction Angle (degrees)	Unit Weight (lb/ft³)	
Clay Liner 100 (Effective) 1000 (Total)	Clay Liner 16 (Effective) 0 (Total)	120	
Protective Cover 100 (Effective) 1000 (Total)	Protective Cover 16 (Effective) 0 (Total)		
Overliner (GCL) 100 (Effective) 1000 (Total)	Overliner (GCL) 16 (Effective) 0 (Total)		
Final Cover System			<p>The final cover system includes the erosion layer and compacted clay infiltration layer.</p> <p>For the rotational global stability analysis, the final cover system is modeled as a single layer and the strength parameters represent the compacted clay infiltration layer and the erosion layer. The strength values selected for the final cover system represent strength values typically used in the industry and these same strength values have been used in various permit applications approved by TCEQ. The global stability analysis for rotational failure analysis uses the soil material strength parameters (i.e., cohesion of 100 lb/ft² and a friction angle of 16 degrees). The global stability analysis is included in Appendix IIIL-A.</p>
Soil Material Strength Parameters			
Cohesion (lb/ft²)	Friction Angle (degrees)	Unit Weight (lb/ft³)	
100	16	120	
Solid Waste			<p>The strength parameters for solid waste were based on information contained in the following references: Pagotto and Rimoldi (1987), Landva and Clark (1990), and Richardson and Reynolds (1991). These sources list cohesion and friction angle values that range from 210 lb/ft² to 605 lb/ft² and 18° (for residual strength or large displacement for direct shear test which requires a factor of safety of 1) to 43°, respectively. The selected strength values (cohesion = 288 psf and friction angle = 23°) are conservatively selected to represent peak strength for MSW. The unit weight of waste was obtained from Appendix IIIB - Site Life Calculations.</p>
Material Strength Parameters			
Cohesion (lb/ft²)	Friction Angle (degrees)	Unit Weight (lb/ft³)	
288	23	47	

5.5 Results of Stability Analysis

The stability analysis results, obtained using the computer program, show that both the proposed excavation and final configuration slopes are stable under the analyzed conditions. Tables 5-2 and 5-3 summarize the stability analysis results for the landfill slopes, comparing the calculated factor of safety to the recommended minimum factors of safety. The recommended minimum factors of safety for the analyzed conditions were based on guidelines from the U.S. Corps of Engineers' "Design and Construction of Levees" manual (EM 1110-2-1913) and the EPA's "Technical Guidance Manual for the Design of Solid Waste Disposal Facilities." Specifically, a factor of safety of 1.3 was used for short-term slope stability (excavation slopes), while a factor of safety of 1.5 was applied for long-term slope stability (overliner and final cover slopes).

Table 5-2 Summary of Slope Stability Analysis for Excavation Slopes

Slope Designation	Method of Analysis	Minimum Factor of Safety Generated		Recommended Minimum of Safety		Acceptable Factor of Safety Met?
		Effective Stress	Total Stress	Effective Stress	Total Stress	
Excavation Slope A-1	Bishop-Circular	1.8	1.9	1.5	1.3	YES
Excavation Slope A-2	Janbu/Randkine	1.7	1.8	1.5	1.3	YES
Excavation Slope B-1	Bishop-Circular	1.8	1.9	1.5	1.3	YES
Excavation Slope B-2	Janbu/Randkine	1.8	1.9	1.5	1.3	YES

Table 5-3 Summary of Slope Stability Analysis for the Final Landfill Configuration

Slope Designation	Method of Analysis	Minimum Factor of Safety Generated		Recommended Minimum of Safety		Acceptable Factor of Safety Met?
		Effective Stress	Total Stress	Effective Stress	Total Stress	
Final Cover C-1	Bishop-Circular	2.4	2.4	1.5	1.3	YES
Final Cover C-2	Janbu/Randkine	2.0	2.0	1.5	1.3	YES
Final Cover D-1	Bishop-Circular	3.1	3.1	1.5	1.3	YES
Final Cover D-2	Janbu/Randkine	3.1	3.1	1.5	1.3	YES
Overliner E-1	Bishop-Circular	2.9	3.3	1.5	1.3	YES
Overliner E-2	Janbu/Randkine	2.9	2.9	1.5	1.3	YES

The computer-generated slope stability analysis output is included in Appendix III-L-A. As shown in Tables 5-2 and 5-3:

- the minimum calculated factor of safety for excavation slopes is 1.7, which exceeds the acceptable minimum factor of safety of 1.5;
- minimum calculated factor of safety for final cover slopes is 2.0, which is well above the acceptable minimum factor of safety of 1.5;
- minimum calculated factor of safety for overliner slopes is 2.4, which is well above the acceptable minimum factor of safety of 1.5.

The stability analysis results demonstrate that all analyzed conditions have an acceptable factor of safety.

6.0 SETTLEMENT, STRAIN, AND HEAVE ANALYSIS

6.1 General

The purpose of the settlement and heave analysis is to ensure that the liner system will not be negatively affected by foundation settlement. This analysis also evaluates the settlement of the final cover system to confirm that the proposed design can accommodate the potential strain caused by waste settlement.

Settlement of the liner system will result from the consolidation of foundation materials under the weight of the landfill components, including the protective cover, solid waste, daily cover, and final cover systems. Laboratory consolidation tests show that the foundation soils have low compressibility. Settlement of the final cover system will occur as a result of both foundation soil consolidation and consolidation within the solid waste. Total consolidation of the final cover includes primary and secondary consolidation of the deposited waste. Appendix III-L-B provides detailed information on the foundation heave, settlement, and final cover settlement analyses.

6.2 Foundation Heave

Potential heave (rebound) resulting from the excavation of overburden above the excavation base was estimated using standard consolidation theory for soils and the recompression index obtained from the rebound portion of the consolidation tests. To estimate the potential for heave, the load is reduced, reflecting the projected weight of the excavated soil, rather than increasing the load on the soils. With a maximum excavation depth of approximately 78 feet (calculated as the difference between the existing ground elevation and the bottom of excavation at a given location), a heave of approximately 5.36 feet was calculated.

The heave estimate provided is considered overly conservative, as it assumes that the underlying shale will heave in accordance with both the limited consolidation testing performed on the shale and the rebound curve from the consolidation test results. In reality, the actual heave is expected to be significantly less. This will be monitored during construction through surveying of excavation and protective cover grades. The depth of floor grade excavation for each sector (liner area draining to an LCS sump) is generally consistent, meaning the depth of soil to be removed does not vary significantly within each sector. Where excavation depth is shallower, heave will also be less and can be considered negligible.

These calculations are included in Appendix III-L-B-1. Heave will occur shortly after excavation (before and during liner construction) and will not negatively impact the performance of the liner system.

6.3 Foundation Settlement and Strain

The potential for foundation settlement has been evaluated using consolidation test results for Stratum III. These test results indicate that the shale in this stratum exhibits characteristics of over-consolidation, meaning that the previous stresses on the unit were greater than the current vertical stresses acting on it. The pre-consolidation pressure is typically considered to represent the maximum vertical overburden stress the soil layer has experienced in the past. For this analysis, the pre-consolidation stresses were incorporated into the settlement and strain evaluations.

The results of these analyses are presented in Appendix III-L-B. As shown in Appendix III-L-B, settlement within the foundation geological unit at the site is negligible and will not negatively impact the performance of the leachate collection system or cause harmful strain on the liner system components.

6.4 Final Cover Settlement and Strain

Settlement of the landfill final cover occurs due to both the settlement of foundation soils and the settlement of waste materials. Generally, the settlement of the foundation soils is minimal compared to the settlement of the deposited waste. Waste settlement consists of both primary and secondary settlement.

Solid waste settlement begins rapidly as it is placed and continues over an extended period of time. Initially, municipal solid waste undergoes primary settlement due to its own weight, the weight of the final cover, equipment, and other factors. Primary settlement occurs quickly, typically within the first month after waste placement. At this point, the weight of the final cover system becomes the only contributing factor to primary consolidation. By the time the final cover construction is completed, settlement of the waste due to the cover's weight will have been fully realized.

Secondary settlement persists at significant rates well beyond the primary settlement phase. This is driven by a combination of mechanical secondary compression, physico-chemical reactions, and bio-chemical decay. The settlement analysis for the final cover system is detailed in Appendix III-L-B-3.

A strain analysis has been incorporated into the final cover settlement analysis presented in Appendix III-L-B-3. The goal of the settlement and strain analysis is to ensure that the final cover system will remain stable as designed and maintain positive drainage. Assuming uniform waste settlement, the sideslopes are expected to maintain positive drainage. Based on the settlement estimates for both the maximum waste thickness (where the most significant settlement is expected to occur on the landfill's top deck) and the minimum waste thickness (where minimal settlement is anticipated), the final cover will experience a maximum strain of -0.008 percent. This strain is well below the allowable strain for the final cover soil infiltration layer. The strain demonstration in Appendix III-L-B-3 confirms that the top deck areas of the final cover will remain stable and maintain a minimum slope of 2.29%, ensuring positive drainage after settlement.

7.0 CONCLUSIONS NAD RECOMMENDATIONS

This geotechnical analysis was developed based on (1) geotechnical data from testing performed on soil samples collected at the site, (2) the general soil stratigraphy of the project area, and (3) the known geotechnical characteristics of solid waste and soils used in landfill components. Based on this analysis, it is concluded that the proposed landfill and its components (such as the leachate collection system) will be geotechnically stable and will function as designed. The key findings of the geotechnical analysis are summarized below:

- All geotechnical engineering tests were conducted in accordance with industry standards and recognized procedures (e.g., ASTM standards).
- The stability of the proposed landfill excavation slopes and final cover is acceptable as designed (refer to Appendix III-L-A).
- Foundation settlement after filling is expected to be negligible and well within the strain limits of the liner system (see Appendix III-L-B).
- Settlement of the final cover system will not negatively impact its performance, and the system will function as intended (see Appendix III-L-B).

CITY OF DEL RIO LANDFILL

VAL VERDE COUNTY, TEXAS

TCEQ PERMIT NO. MSW-207C

MAJOR PERMIT AMENDMENT APPLICATION PART III – SITE DEVELOPMENT

APPENDIX III-L-A SLOPE STABILITY ANALYSIS

Prepared for
City of Del Rio

September 2023

[Revision 1 March 2025](#)



Prepared by
CP&Y an STV Company
TPBE Registration No. F-1741
13155 Noel Road, Suite 200
Dallas, TX 75240
214-638-0500

This document is intended for permitting purposes only.

TABLE OF CONTENTS

1.0 INTRODUCTION IIII-A-3

LIST OF FIGURES

Figure IIII-A-5 – Excavation Slope Stability Section Location IIII-A-5
Figure IIII-A-6 – Excavation Slope Cross Sections IIII-A-6
Figure IIII-A-88 – Final Cover Slope Stability Section Location IIII-A-88
Figure IIII-A-89 – Final Cover Slope Cross Sections IIII-A-89



1.0 INTRODUCTION

This appendix includes the slope stability analysis for the landfill slopes during various phases of the site development and the final landfill configuration. General slope stability for the excavation and closed conditions were evaluated by using the Slide 2D computer program. The Simplified Bishop method was used for circular failure surfaces, and the Simplified Janbu method using Rankine Block was used for the translational slope stability analysis. Soil profiles analyzed for each configuration for the slope stability analysis are provided in the sub-appendices, along with the Slide computer output files as applicable. The stability analysis for the site is provided in the following appendices.

- The slope stability analysis for the excavated landfill condition is shown on pages IIII-A-4 through IIII-A-86.
- The slope stability analysis for the closed landfill conditions are shown on pages IIII-A-87 through IIII-A-215.

**EXCAVATION CONFIGURATION
STABILITY ANALYSIS**

LEGEND

- GP-5
- UV-1
- CUT/FILL MARKERS
- PROPOSED GAS PROBE
- PROPOSED GAS VENTS
- PROPOSED PERMIT BOUNDARY
- PROPOSED LIMIT OF WASTE
- CELL BOUNDARY
- EXISTING GRADES
- PROPOSED EXCAVATION GRADES
- PERMITTED EXCAVATION GRADES
- PERMITTED OVERLINER GRADES
- CELL DESIGNATION
- PROPOSED LEACHATE COLLECTION RISER
- PROPOSED LEACHATE COLLECTION CLEANOUT
- PROPOSED LEACHATE COLLECTION SUMP
- PROPOSED LEACHATE COLLECTION LINE

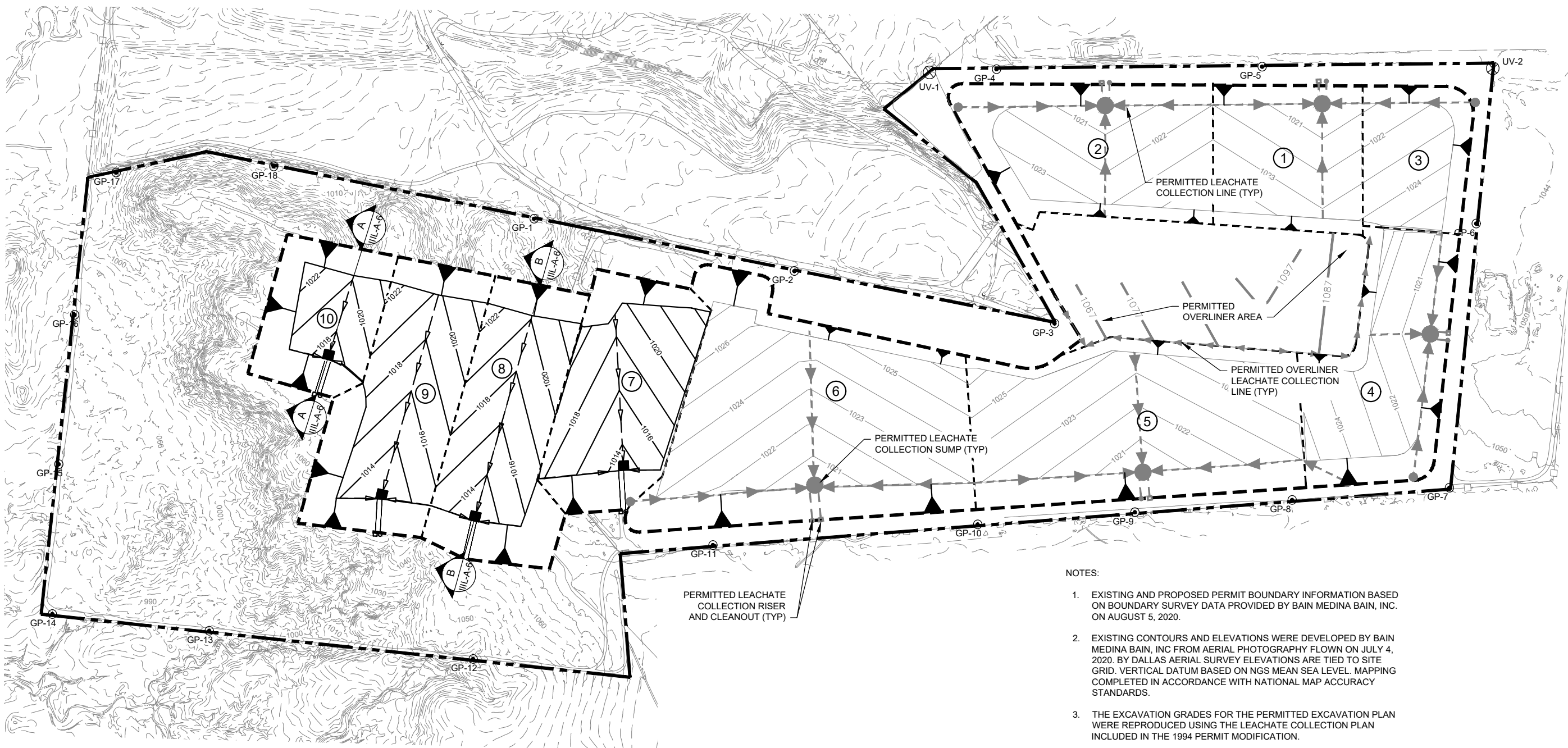
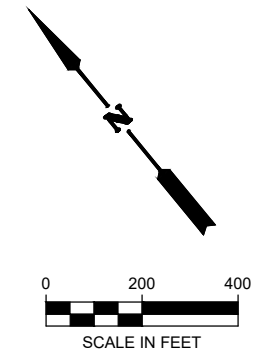

- NOTES:**
- EXISTING AND PROPOSED PERMIT BOUNDARY INFORMATION BASED ON BOUNDARY SURVEY DATA PROVIDED BY BAIN MEDINA BAIN, INC. ON AUGUST 5, 2020.
 - EXISTING CONTOURS AND ELEVATIONS WERE DEVELOPED BY BAIN MEDINA BAIN, INC FROM AERIAL PHOTOGRAPHY FLOWN ON JULY 4, 2020. BY DALLAS AERIAL SURVEY ELEVATIONS ARE TIED TO SITE GRID. VERTICAL DATUM BASED ON NGS MEAN SEA LEVEL. MAPPING COMPLETED IN ACCORDANCE WITH NATIONAL MAP ACCURACY STANDARDS.
 - THE EXCAVATION GRADES FOR THE PERMITTED EXCAVATION PLAN WERE REPRODUCED USING THE LEACHATE COLLECTION PLAN INCLUDED IN THE 1994 PERMIT MODIFICATION.
 - EXCAVATION SLOPES ARE TYPICALLY 3H:1V.
 - MINIMUM EXCAVATION ELEVATION AT LEACHATE COLLECTION SYSTEM SUMP IS 1007 FT-MSL.
 - LINER AND LEACHATE COLLECTION SYSTEM DETAILS ARE INCLUDED IN APPENDIX IIIA-A.



NO.	1ST TECHNICAL NO.	REVISION	BY	DATE
1.			STV	03/2025

VERIFY SCALE BAR LENGTH EQUALS ONE INCH ON ORIGINAL DRAWING. VERIFY LENGTH ON THIS SHEET 0' AND ADJUST SCALE ACCORDINGLY.

CITY OF DEL RIO LANDFILL NO. 207C
MAJOR PERMIT AMENDMENT

EXCAVATION SLOPE STABILITY
SECTION LOCATION

DESIGN: T. METAFERIA
DRAWN: T. METAFERIA
REVIEW: B. HINDMAN
CP&Y: DELR200302
CLIENT: CITY OF DEL RIO

FIGURE
IIIL-A-5

FOR PERMITTING PURPOSES ONLY

PRINTED BY: Metaferia T DATE: 3/21/2025
FILE PATH: C:\pwworking\st\metaferia\0942279\DEL200302\Figure III-A-5.dwg

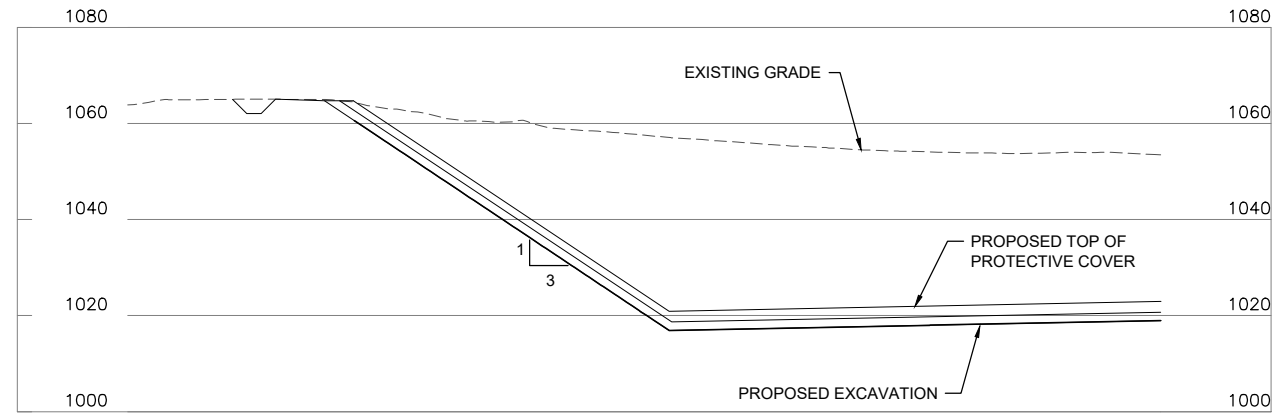

A
III-L-A-5
EXCAVATION SECTION
HORZ 0 40 80
VERT 0 4 8
SCALE IN FEET

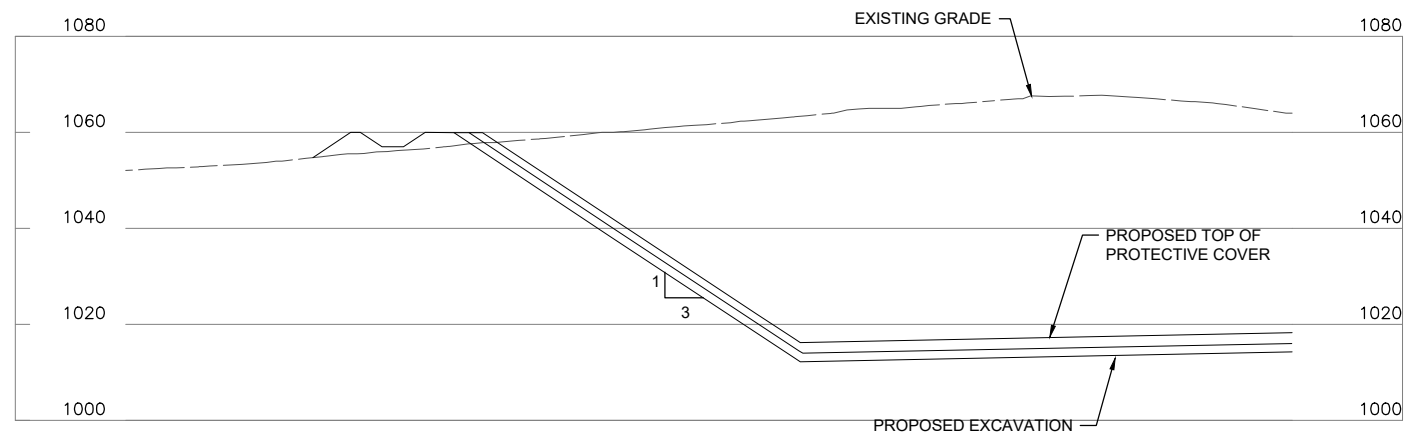

B
III-L-A-5
EXCAVATION SECTION
HORZ 0 40 80
VERT 0 4 8
SCALE IN FEET



NO.	1ST TECHNICAL NOD	REVISION	BY	DATE
1.			STV	03/2025

VERIFY SCALE BAR LENGTH EQUALS ONE INCH ON ORIGINAL DRAWING. VERIFY LENGTH ON THIS SHEET AND ADJUST SCALE ACCORDINGLY.

CITY OF DEL RIO LANDFILL NO. 207C
MAJOR PERMIT AMENDMENT

EXCAVATION SLOPE
SECTION LOCATION

DESIGN: T. METAFERIA
DRAWN: T. METAFERIA
REVIEW: B. HINDMAN
CP&Y: DELR200302
CLIENT: CITY OF DEL RIO

FIGURE
III-L-A-6



FOR PERMITTING PURPOSES ONLY

Excavation Landfill Configuration Stability Analysis

Client: City of Del Rio
Project: Major Permit Amendment
Description: Excavation Configuration
Stability Analysis

Date: 3/7/2025
Job No: DELR200302
By: T. Metaferia
Checked By: B. Hindman

Purpose - Evaluate the slope stability of the permitted landfill excavation configuration slope.

- 1 The location of the critical section selected for the stability analysis for the slope is shown on Sheet IIII-A-5. Sections analyzed are shown with the most critical failure surfaces on Sheet IIII-A-6 and IIII-A-6.
- 2 The soil profile used for each analysis was based on boring log data from site investigations conducted 1989, 1994, and 2020 (Refer to Appendix IIIJ).
- 3 A summary table of the assumed material weight and strength properties is provided on Sheets IIII-A-8. The material weight and strength parameter determination for each material type was based on previous laboratory testing results (Atterberg limits, natural moisture contents, unit weight, percent passing #200 sieve, standard Proctor, and strength testing), field strength testing (pocket penetrometer and standard penetration testing (SPT)), and engineering judgment from previous experience with similar materials. Laboratory testing results for the site soils are included in Appendix IIIJ.

Reference

- 1 Bowles, Joseph E., Foundation Analyses and Design, 4th Ed., Mc-Graw-Hill, 1988.
- 2 Duncan, J.M. and Buchignani, A.L., An Engineering Manual for Slope Stability Studies, Department of Civil Engineering-University of California-Berkeley, 1975.
- 3 Slide 2D 2018 (computer program for slope stability analyses), Interactive Software.

Excavation Landfill Configuration Stability Analysis

Client: City of Del Rio
Project: Major Permit Amendment
Description: Excavation Configuration Stability Analysis

Date: 3/7/2025
Job No: DELR200302
By: T. Metaferia
Checked By: B. Hindman

Derivation of Slope Stability Parameters:

Laboratory testing data and field testing results are provided on logs included in Appendix IIIJ. The following includes material strength properties based on the laboratory testing results and field test results for each subsurface unit.

Material/Unit	Unit Weight (pcf)
Stratum I	111.1
Stratum II	110.9
Stratum III	109.7

The strength parameters used for analysis of the in-situ soils were selected based on the following:

Stratum II

The summary of the calculated cohesion and friction angles are shown on Pages IIII-A-9. There is no groundwater at the site, therefore the soil parameters used for all the slope stability analysis for Stratum II and III only utilize effective stress. The liner soil parameters were modeled using the total and effective stress shown on Table 5-1 on page IIII-14.

	Total Stress		Effective Stress	
	Cohesion (lb/ft ²)	Friction Angle (phi)	Cohesion (lb/ft ²)	Friction Angle (phi)
Stratum II	4000.0	0.0	206.0	26

Stratum III

	Total Stress		Effective Stress	
	Cohesion	Friction Angle	Cohesion	Friction Angle
Stratum III	2800.0	0.0	150.0	24

Factor of Safety Summary for Excavation Slope Stability Analysis

Description		Minimum Factor of Safety Generated		Recommended Minimum Factor of		Acceptable Factor of Safety	
		Effective Stress	Total Stress	Effective Stress	Total Stress	Effective Stress	Total Stress
Slope Designation	Method of Analysis						
Excavation A-1	Bishop-Circular	1.8	1.9	1.5	1.3	YES	YES
Excavation A-2	Janbu - Non Circular	1.7	1.8	1.5	1.3	YES	YES
Excavation B-1	Bishop-Circular	1.8	1.9	1.5	1.3	YES	YES
Excavation B-2	Janbu - Non Circular	1.8	1.9	1.5	1.3	YES	YES

Summary of Stratum II - Arias Geotechnical Calculations

Boring No.	Cohesion c' (psf)	Friction Angle (phi)	Cohesion c' (psf)	Friction Angle (phi)
Stratum II – Arias and Associates, Inc (2020)				
B-1	100	25	2500	0
B-3	500	33	8000	0
B-4	100	24	2500	0
B-5	100	25	2800	0
B-6	150	24	2800	0
B-7	100	25	2800	0
B-11	150	26	3000	0
B-12	150	25	3500	0
B-16	500	30	8000	0
COMPUTATIONS – Stratum II				
Mean	206	26	4000	0

Summary of Stratum III - Arias Geotechnical Calculations

Boring No.	Cohesion c' (psf)	Friction Angle (phi)	Cohesion c' (psf)	Friction Angle (phi)
Stratum III – Arias and Associates, Inc (2020)				
B-1	150	24	3000	0
B-2	150	23	3000	0
B-3	150	23	3000	0
B-4	150	24	3000	0
B-5	150	24	2800	0
B-6	150	24	2800	0
B-7	150	24	2800	0
B-8	150	24	3500	0
B-9	150	24	2800	0
B-10	150	24	2800	0
B-11	150	24	2800	0
B-12	150	24	2800	0
B-13	150	24	2800	0
B-14	150	24	2800	0
B-15	150	24	2800	0
B-16	150	24	2800	0
B-17	150	24	2800	0
COMPUTATIONS – Stratum III				
Mean	150	24	2888	0

Refer to the clean copy for the Slide2 Output pages for the excavation sections

**OVERLINER AND FINAL CONFIGURATION
STABILITY ANALYSIS**

LEGEND

	PERMIT BOUNDARY
	CLOSED CELL BOUNDARY
	LIMIT OF WASTE
	FINAL COVER GRADES
	EXISTING GRADES
	PERIMETER CHANNEL
	SWALES
	PROPOSED SITE FENCE
	EXISTING CHUTE
	CHUTES
	PROPOSED GAS PROBE
	PROPOSED GAS VENTS

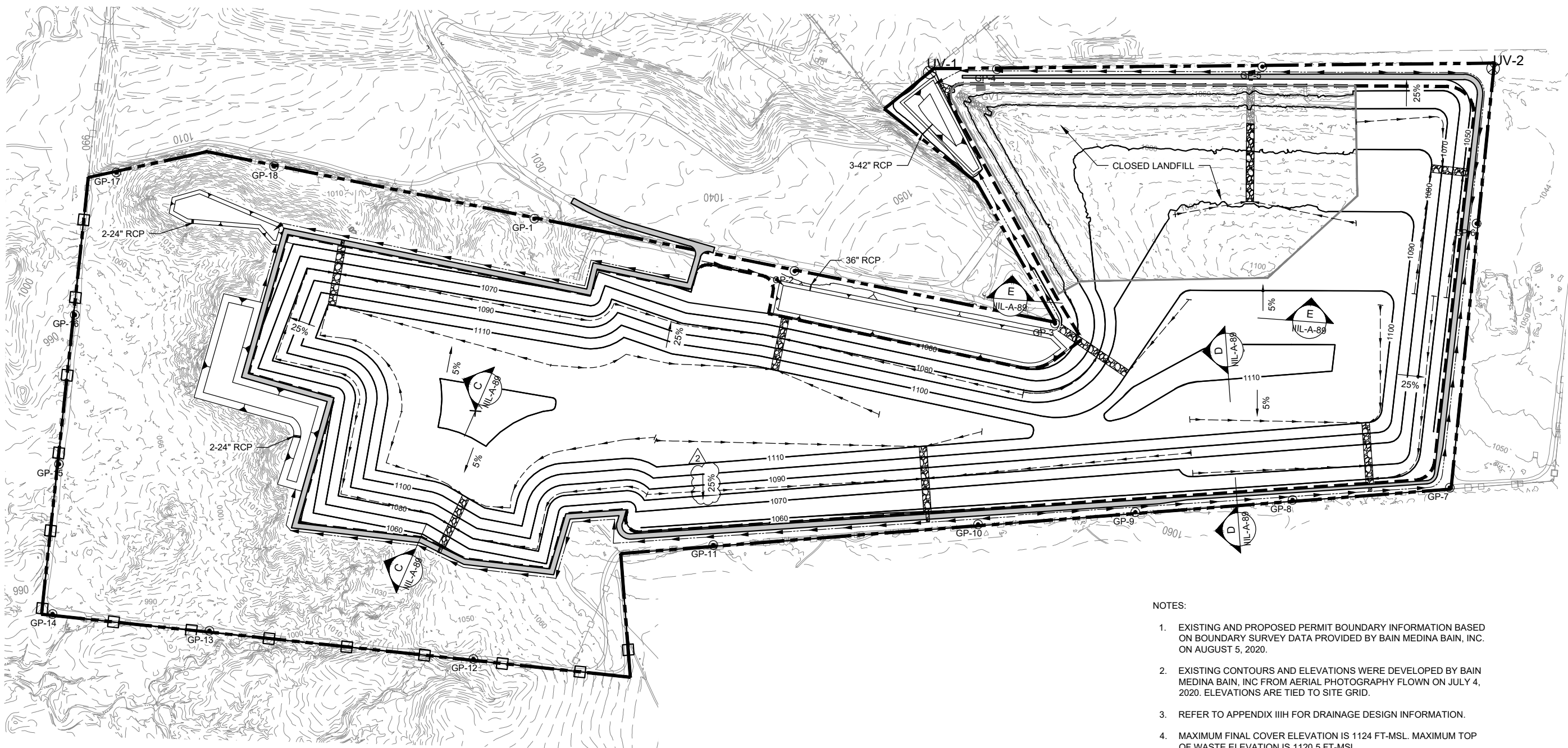
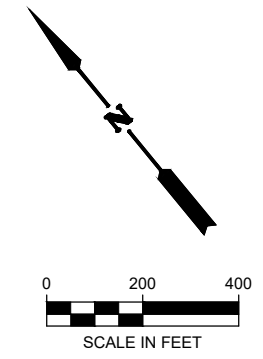

- NOTES:**
1. EXISTING AND PROPOSED PERMIT BOUNDARY INFORMATION BASED ON BOUNDARY SURVEY DATA PROVIDED BY BAIN MEDINA BAIN, INC. ON AUGUST 5, 2020.
 2. EXISTING CONTOURS AND ELEVATIONS WERE DEVELOPED BY BAIN MEDINA BAIN, INC FROM AERIAL PHOTOGRAPHY FLOWN ON JULY 4, 2020. ELEVATIONS ARE TIED TO SITE GRID.
 3. REFER TO APPENDIX IIIH FOR DRAINAGE DESIGN INFORMATION.
 4. MAXIMUM FINAL COVER ELEVATION IS 1124 FT-MSL. MAXIMUM TOP OF WASTE ELEVATION IS 1120.5 FT-MSL.
 5. TYPICAL TOPSLOPE IS 5%. TYPICAL SIDESLOPES ARE 4H:1V EXCEPT IN THE AREA OF THE CLOSED PORTION OF THE LANDFILL IN WHICH THE SIDESLOPES ARE 5H:1V.



NO.	REVISION	BY	DATE
1.	2ND TECHNICAL NOD	STV	03/2025

VERIFY SCALE BAR LENGTH EQUALS ONE INCH ON ORIGINAL DRAWING. VERIFY LENGTH ON THIS SHEET 0" 1" AND ADJUST SCALE ACCORDINGLY.

CITY OF DEL RIO LANDFILL NO. 207C
MAJOR PERMIT AMENDMENT

FINAL COVER & OVERLINER SLOPE STABILITY SECTION LOCATION

DESIGN: T. METAFERIA
DRAWN: T. METAFERIA
REVIEW: B. HINDMAN
CP&Y: DELR200302
CLIENT: CITY OF DEL RIO

FIGURE
IIL-A-88

FOR PERMITTING PURPOSES ONLY

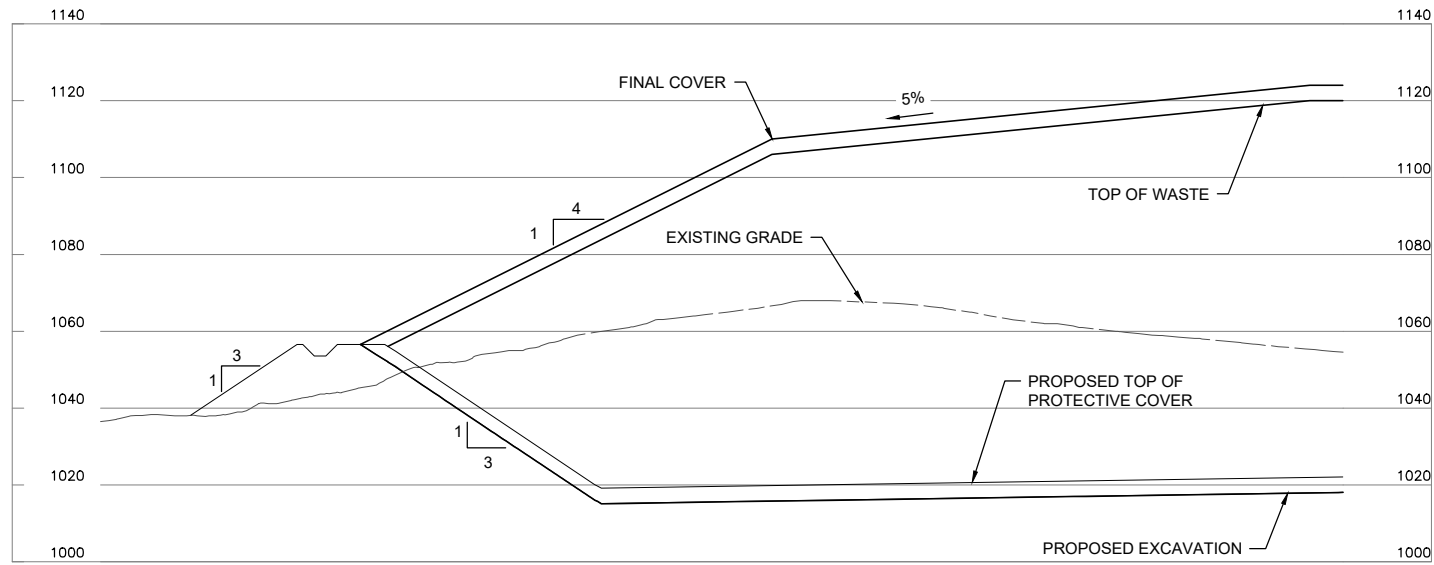

C FINAL COVER SECTION
 IILL-A-5
 HORZ 0 50 100
 VERT 0 5 10
 SCALE IN FEET

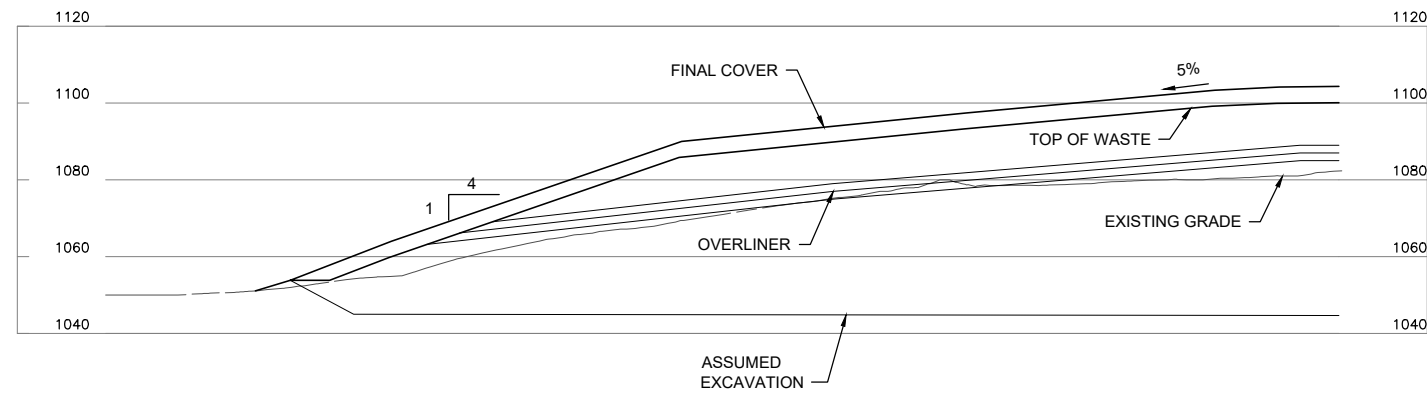

E OVERLINER
 IILL-A-5
 HORZ 0 50 100
 VERT 0 5 10
 SCALE IN FEET

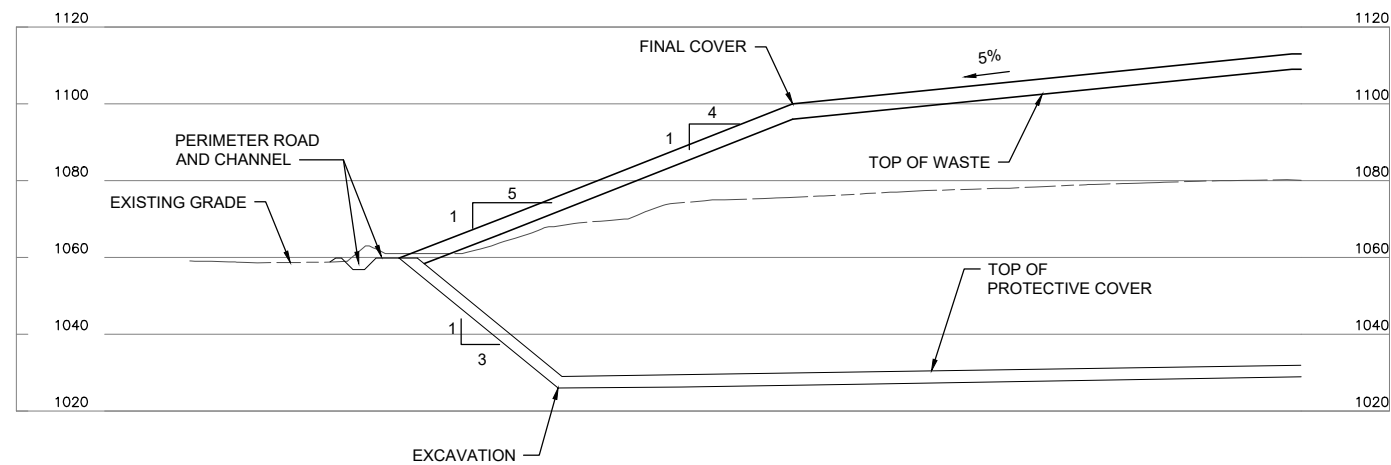

D FINAL COVER SECTION
 IILL-A-5
 HORZ 0 50 100
 VERT 0 5 10
 SCALE IN FEET

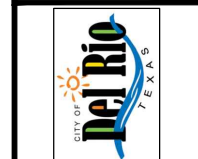

NO.	1ST TECHNICAL NOD	REVISION	BY	DATE
1.			STV	03/2025

VERIFY SCALE BAR LENGTH EQUALS ONE INCH ON ORIGINAL DRAWING. VERIFY LENGTH ON THIS SHEET 0" AND ADJUST SCALE ACCORDINGLY.

CITY OF DEL RIO LANDFILL NO. 207C
 MAJOR PERMIT AMENDMENT

OVERLINER AND FINAL COVER SLOPE
 CROSS SECTIONS

DESIGN: T. METAFERIA
 DRAWN: T. METAFERIA
 REVIEW: B. HINDMAN
 CP&Y: DELR200302
 CLIENT: CITY OF DEL RIO

FIGURE
 IILL-A-89



FOR PERMITTING PURPOSES ONLY

PRINTED BY: Metaferia
 FILE PATH: C:\pwworking\st\metaferia\0944279\DELRLR200302 Slope Stability Cross Section.dwg

Overliner & Final Cover Landfill Configuration Stability Analysis

Client: City of Del Rio
Project: Major Permit Amendment
Description: Overliner and Final Configuration
 Stability Analysis

Date: 3/7/2025
Job No: DELR200302
By: T. Metaferia
Checked By: B. Hindman

Purpose - Evaluate the slope stability of the proposed landfill overliner and final cover configuration slope.

1 The location of the critical section selected for the stability analysis for the slope is shown on Sheet IILL-A-88. The cross sections are shown on IILL-A-89.

2 The soil profile used for each analysis was based on boring log data from previous site investigations (see Appendix IIIJ).

A summary table of the assumed material weight and strength properties is provided on Sheet IILL-A-91. The material weight and strength parameter determination for each material type was based on previous laboratory testing results (Atterberg limits, natural moisture contents, unit weight, percent passing #200 sieve, standard Proctor, and strength testing), field strength testing (pocket penetrometer and standard penetration testing (SPT)), and engineering judgment from previous experience with similar materials. Laboratory testing results for the site soils are included in Appendix IILL-C.

Reference

1 Bowles, Joseph E., Foundation Analyses and Design, 4th Ed., Mc-Graw-Hill, 1988.

2 Duncan, J.M. and Buchignani, A.L., An Engineering Manual for Slope Stability Studies, Department of Civil Engineering-University of California-Berkeley, 1975.

3 Slide 2D 2018 (computer program for slope stability analyses), Interactive Software.

Overliner and Final Cover Landfill Configuration Stability Analysis

Client: City of Del Rio
Project: Major Permit Amendment
Description: Overliner & Final Cover Configuration
 Stability Analysis

Date: 3/7/2025
Job No: DELR200302
By: T. Metaferia
Checked By: B. Hindman

Derivation of Slope Stability Parameters:

Laboratory testing data and field testing results are provided on logs included in Appendix IIIJ. The following includes material strength properties based on the laboratory testing results and field test results for each subsurface unit.

Material/Unit	Unit Weight (pcf)
Stratum I	111.1
Stratum II	110.9
Stratum III	109.7

The strength parameters used for analysis of the in-situ soils were selected based on the following:

Stratum II

The summary of the calculated cohesion and friction angles are shown on Pages IILL-A-XX. There is no groundwater at the site, therefore the soil parameters used for all the slope stability analysis for Stratum II and III only utilize effective stress. The liner soil parameters were modeled using the total and effective stress shown on Table 5-1 on page IILL-14.

	Total Stress		Effective Stress	
	Cohesion (lb/ft ²)	Friction Angle (phi)	Cohesion (lb/ft ²)	Friction Angle (phi)
Stratum II	4000.0	0.0	206.0	26

Stratum III

	Total Stress		Effective Stress	
	Cohesion (lb/ft ²)	Friction Angle (phi)	Cohesion (lb/ft ²)	Friction Angle (phi)
Stratum III	2800.0	0.0	150.0	24

Solid Waste Input Parameters:

Soil Description	Moist Unit Weight (pcf)	Cohesion (psf)	Friction Angle (degrees)
Solid Waste	59.0	288.0	23.0

The above information was derived from several references. Reference 3 provides a summary of several studies that have been completed to develop the shear strength parameters for MSW (refer to Chapter 6.7 in Ref. 3). MSW shear strength parameters reported in technical literature references vary widely, with friction angles as low as 10° and as high as 53°, and cohesion values varying from 0 psf to 1,400 psf. Many of the lower values are directly contradicted by observations of actual stable landfill slopes. A summary list of a few of the studies completed is provided below.

Reference	Data Type	Results
Pagotto & Rimoldi (1987)	Back-calculation from plate bearing tests	$\phi = 22^\circ$ c = 605 psf (29 kPa)
Landva & Clark (1990)	Laboratory direct shear tests on MSW	$\phi = 24^\circ$, c = 460 psf (22 kPa) to $\phi = 39^\circ$, c = 400 psf (19 kPa)
Richardson & Reynolds (1991)	Large direct shear tests performed in-situ	$\phi = 18^\circ$ to 43° c = 210 psf (10 kPa)

To provide for a conservative analysis, a cohesion value of 288 psf and a friction angle of 23° were selected.

The moist unit weight is estimated at the midpoint of the average depth to represent the average unit weight of waste/cover soil within the landfill, consistent with what is used in the site life calculations in Appendix IIIB

Factor of Safety Summary for Final Slope Stability Analysis

Description		Minimum Factor of Safety Generated		Recommended Minimum Factor of Safety		Acceptable Factor of Safety	
Slope Designation	Method of Analysis	Effective	Total	Effective	Total	Effective	Total
		Final Cover C-1	Bishop-Circular	2.4	2.4	1.5	1.3
Final Cover D-1	Bishop-Circular	3.1	3.1	1.5	1.3	YES	YES
Overliner E-1	Bishop-Circular	2.9	3.3	1.5	1.3	YES	YES

Description		Minimum Factor of Safety Generated		Recommended Minimum Factor of Safety		Acceptable Factor of Safety	
Slope Designation	Method of Analysis	Effective	Total	Effective	Total	Effective	Total
		Final Cover C-2	Janbu	2.0	2.0	1.5	1.3
Final Cover D-2	Janbu	3.1	3.1	1.5	1.3	YES	YES
Overliner E-2	Janbu	2.9	2.9	1.5	1.3	YES	YES

Minimum Required Interface Strength Parameters

Landfill Component	Interface	Peak		Residual	
		Adhesion (psf)	Friction Angle (degrees)	Adhesion (psf)	Friction Angle (degrees)
Liner	Protective Cover/ Geocomposite	100.0	18.0	80.0	14.0
Liner	Geocomposite/ Textured Geomembrane	100.0	21.0	80.0	10.0
Liner	Textured Geomembrane/ Geosynthetic Clay Liner	100.0	18.0	80.0	10.0

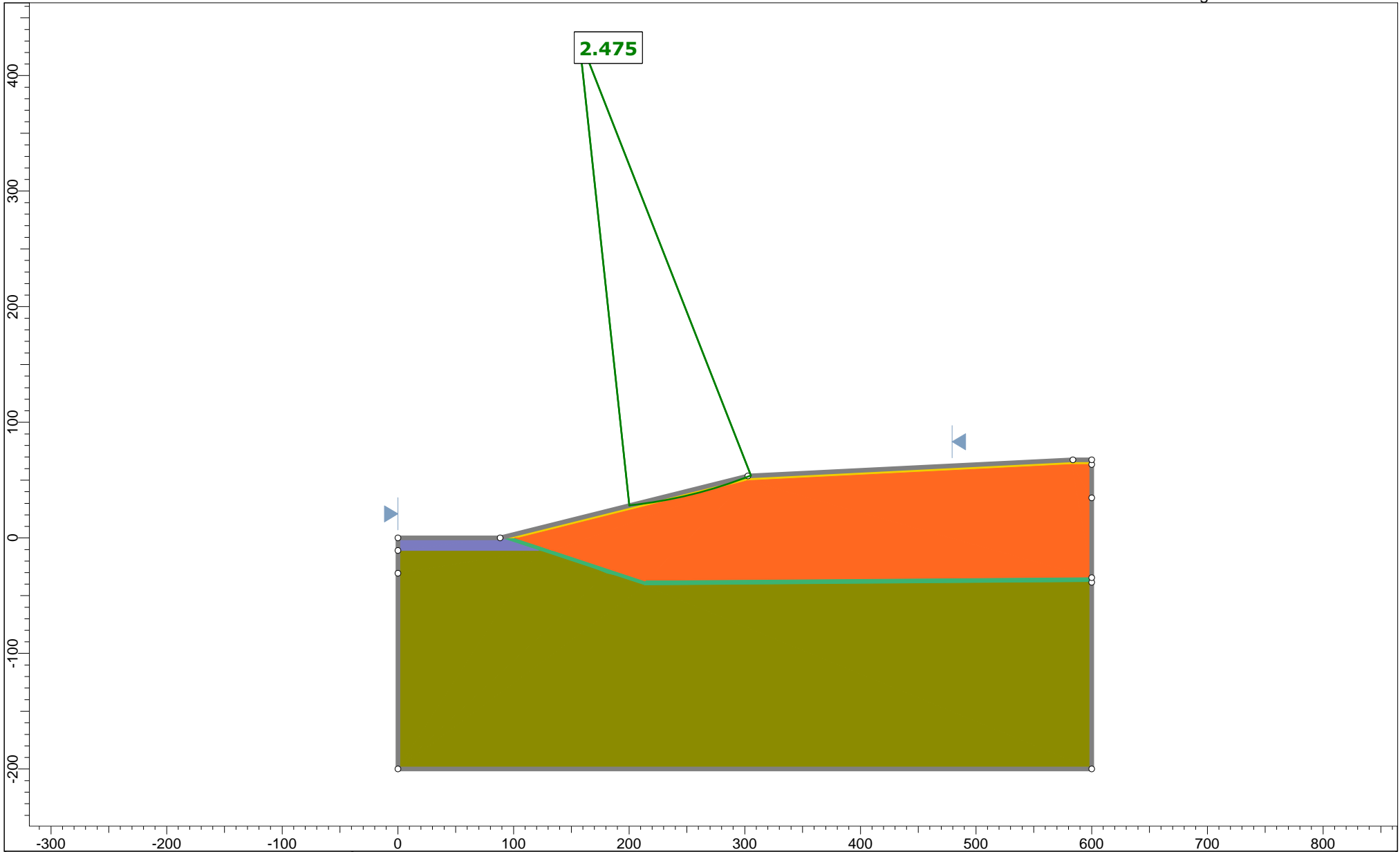

SLIDEINTERPRET 9.018

<i>Project</i>	SLIDE - An Interactive Slope Stability Program	
<i>Group</i>	Simplified Bishop Method - Effective Stress	<i>Scenario</i> Master Scenario
<i>Drawn By</i>		<i>Company</i>
<i>Date</i>		<i>File Name</i> Slide2-FC Section C_Effective Stress.slmd

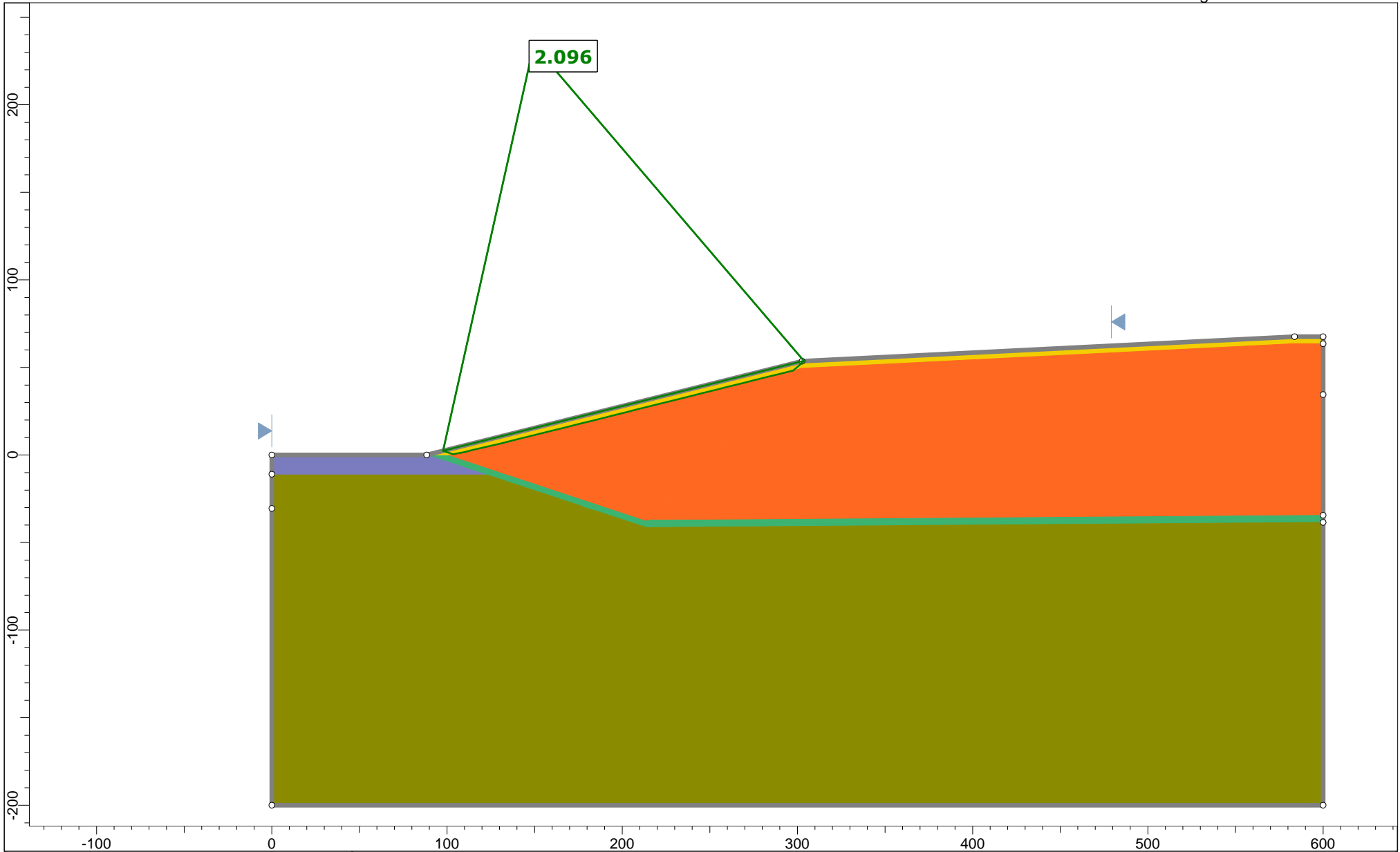

	Project SLIDE - An Interactive Slope Stability Program	
	Group Simplified Janbu Method - Effective Stress	Scenario Master Scenario
	Drawn By	Company
	Date	File Name Slide2-FC Section C_Effective Stress.slmd

Materials

Final Cover

Color	
Strength Type	Mohr-Coulomb
Unit Weight [lbs/ft ³]	120
Cohesion [psf]	100
Friction Angle [deg]	16
Water Surface	Assigned per scenario
Ru Value	0

Liner

Color	
Strength Type	Mohr-Coulomb
Unit Weight [lbs/ft ³]	120
Cohesion [psf]	100
Friction Angle [deg]	16
Water Surface	Assigned per scenario
Ru Value	0

Waste

Color	
Strength Type	Mohr-Coulomb
Unit Weight [lbs/ft ³]	47
Cohesion [psf]	288
Friction Angle [deg]	23
Water Surface	Assigned per scenario
Ru Value	0





Stratum II

Color	
Strength Type	Mohr-Coulomb
Unit Weight [lbs/ft ³]	110.9
Cohesion [psf]	206
Friction Angle [deg]	26
Water Surface	Assigned per scenario
Ru Value	0

Stratum III

Color	
Strength Type	Mohr-Coulomb
Unit Weight [lbs/ft ³]	109.7
Cohesion [psf]	150
Friction Angle [deg]	24
Water Surface	Assigned per scenario
Ru Value	0

Materials In Use

Material		Simplified Bishop Method - Effective Stress	Simplified Janbu Method - Effective Stress
Final Cover		✓	✓
Liner		✓	✓
Waste		✓	✓
Stratum II		✓	✓
Stratum III		✓	✓

Global Minimums

◆ Simplified Bishop Method - Effective Stress

Method: bishop simplified

FS	2.474790
Center:	156.527, 433.638
Radius:	408.086
Left Slip Surface Endpoint:	200.091, 27.884
Right Slip Surface Endpoint:	305.279, 53.628
Resisting Moment:	8.35479e+06 lb-ft
Driving Moment:	3.37595e+06 lb-ft
Total Slice Area:	287.057 ft ²
Surface Horizontal Width:	105.188 ft
Surface Average Height:	2.72898 ft

◆ Simplified Janbu Method - Effective Stress

Method: janbu simplified

FS	2.096190
Axis Location:	149.584, 234.059
Left Slip Surface Endpoint:	97.751, 2.335
Right Slip Surface Endpoint:	303.864, 53.558
Resisting Horizontal Force:	46434.8 lb
Driving Horizontal Force:	22153.7 lb
Total Slice Area:	796.01 ft ²
Surface Horizontal Width:	206.113 ft
Surface Average Height:	3.862 ft

Global Minimum Coordinates

◆ Simplified Janbu Method - Effective Stress

Method: janbu simplified

X	Y
97.7513	2.33455
103.434	0.353304
109.977	1.63821
113.248	2.46138
116.52	3.28455
123.609	4.92752
130.698	6.53972
140.245	8.90932
149.367	11.1864
158.952	13.5837
164.345	14.9293
170.764	16.5325
177.195	18.1407
183.625	19.7469
190.056	21.3543
196.486	22.96
202.194	24.3874
207.902	25.8147
214.543	27.4745
221.184	29.1343
227.824	30.7921
234.465	32.4498
240.482	33.9554
246.477	35.4555
254.171	37.3783
259.574	38.732
264.233	39.8945
269.409	41.1843
276.135	42.865
282.86	44.5442
290.229	46.3853
297.597	48.225
303.864	53.558

Valid and Invalid Surfaces

◆ Simplified Bishop Method - Effective Stress

Method: bishop simplified

Number of Valid Surfaces:	12000
Number of Invalid Surfaces:	0

◆ Simplified Janbu Method - Effective Stress

Method: janbu simplified

Number of Valid Surfaces:	23144
Number of Invalid Surfaces:	1915

Error Codes

Error Code -106 reported for 7 surfaces
 Error Code -108 reported for 46 surfaces
 Error Code -111 reported for 485 surfaces
 Error Code -112 reported for 444 surfaces
 Error Code -121 reported for 100 surfaces
 Error Code -124 reported for 1 surface
 Error Code -145 reported for 82 surfaces
 Error Code -1000 reported for 750 surfaces

Error Code Descriptions

The following errors were encountered during the computation:

- 106 = Average slice width is less than $0.0001 * (\text{maximum horizontal extent of soil region})$. This limitation is imposed to avoid numerical errors which may result from too many slices, or too small a slip region.
- 108 = Total driving moment or total driving force < 0.1 . This is to limit the calculation of extremely high safety factors if the driving force is very small (0.1 is an arbitrary number).
- 111 = Safety factor equation did not converge
- 112 = The coefficient $M\text{-Alpha} = \cos(\alpha)(1 + \tan(\alpha)\tan(\phi)/F) < 0.2$ for the final iteration of the safety factor calculation. This screens out some slip surfaces which may not be valid in the context of the analysis, in particular, deep seated slip surfaces with many high negative base angle slices in the passive zone.
- 121 = Concave failure surface, only convex surfaces have been defined as being allowed.
- 124 = A slice has a width less than the minimum acceptable value.
- 145 = Slip surface was clipped vertically by a weak layer in a region of compression. Such a surface cannot be evaluated using Limit Equilibrium. For more information, see Help Documentation on weak layers.
- 1000 = No valid slip surface is generated

Slice Data

◆ Simplified Bishop Method - Effective Stress

Global Minimum Query (bishop simplified) - Safety Factor: 2.47479

Slice Number	Width [ft]	Weight [lbs]	Angle of Slice Base [deg]	Base Material	Base Cohesion [psf]	Base Friction Angle [deg]	Shear Stress [psf]	Shear Strength [psf]	Base Normal Stress [psf]	Pore Pressure [psf]	Effective Normal Stress [psf]	Base Vertical Stress [psf]	Effective Vertical Stress [psf]
1	2.10377	37.0869	6.27669	Final Cover	100	16	41.9167	103.735	13.0259	0	13.0259	17.6363	17.6363
2	2.10377	109.866	6.57393	Final Cover	100	16	45.8472	113.462	46.9483	0	46.9483	52.2319	52.2319
3	2.10377	179.852	6.87134	Final Cover	100	16	49.6212	122.802	79.5206	0	79.5206	85.5002	85.5002
4	2.10377	247.04	7.16895	Final Cover	100	16	53.2388	131.755	110.742	0	110.742	117.438	117.438
5	2.10377	311.425	7.46675	Final Cover	100	16	56.6998	140.32	140.613	0	140.613	148.044	148.044
6	2.10377	373.001	7.76475	Final Cover	100	16	60.0043	148.498	169.133	0	169.133	177.315	177.315
7	2.10377	431.763	8.06296	Final Cover	100	16	63.1522	156.288	196.301	0	196.301	205.247	205.247
8	2.10377	487.703	8.36139	Final Cover	100	16	66.1435	163.691	222.118	0	222.118	231.84	231.84
9	2.10377	540.817	8.66005	Final Cover	100	16	68.9781	170.706	246.582	0	246.582	257.088	257.088
10	2.10377	591.096	8.95895	Final Cover	100	16	71.6558	177.333	269.692	0	269.692	280.989	280.989
11	2.10377	638.535	9.2581	Final Cover	100	16	74.1766	183.572	291.449	0	291.449	303.54	303.54
12	2.10377	683.127	9.5575	Final Cover	100	16	76.5404	189.421	311.849	0	311.849	324.737	324.737
13	2.10377	724.863	9.85716	Final Cover	100	16	78.747	194.882	330.894	0	330.894	344.577	344.577
14	2.10377	763.736	10.1571	Final Cover	100	16	80.7964	199.954	348.581	0	348.581	363.056	363.056
15	2.10377	799.738	10.4573	Final Cover	100	16	82.6882	204.636	364.909	0	364.909	380.17	380.17
16	2.10377	832.861	10.7578	Final Cover	100	16	84.4225	208.928	379.876	0	379.876	395.917	395.917
17	2.10377	863.097	11.0586	Final Cover	100	16	85.9988	212.829	393.482	0	393.482	410.29	410.29
18	2.10377	890.436	11.3597	Final Cover	100	16	87.4171	216.339	405.724	0	405.724	423.287	423.287
19	2.10377	914.87	11.6612	Final Cover	100	16	88.6774	219.458	416.601	0	416.601	434.902	434.902
20	2.10377	936.389	11.9629	Final Cover	100	16	89.7793	222.185	426.11	0	426.11	445.132	445.132
21	2.10377	954.983	12.265	Final Cover	100	16	90.7224	224.519	434.249	0	434.249	453.972	453.972
22	2.10377	970.644	12.5675	Final Cover	100	16	91.5068	226.46	441.017	0	441.017	461.417	461.417
23	2.10377	983.359	12.8703	Final Cover	100	16	92.1315	228.006	446.412	0	446.412	467.462	467.462
24	2.10377	993.12	13.1735	Final Cover	100	16	92.5974	229.159	450.43	0	450.43	472.103	472.103
25	2.10377	999.914	13.477	Final Cover	100	16	92.9028	229.915	453.069	0	453.069	475.333	475.333
26	2.10377	1003.73	13.7809	Final Cover	100	16	93.0487	230.276	454.326	0	454.326	477.149	477.149
27	2.10377	1004.56	14.0853	Final Cover	100	16	93.0342	230.24	454.2	0	454.2	477.543	477.543
28	2.10377	1002.39	14.39	Final Cover	100	16	92.8588	229.806	452.687	0	452.687	476.512	476.512
29	2.10377	997.203	14.6951	Final Cover	100	16	92.5222	228.973	449.783	0	449.783	474.048	474.048

30	2.10377	988.993	15.0007	Final Cover	100	16	92.0244	227.741	445.487	0	445.487	470.146	470.146
31	2.10377	977.745	15.3067	Final Cover	100	16	91.3649	226.109	439.794	0	439.794	464.8	464.8
32	2.10377	963.445	15.6132	Final Cover	100	16	90.543	224.075	432.701	0	432.701	458.003	458.003
33	2.10377	946.081	15.9201	Final Cover	100	16	89.5587	221.639	424.204	0	424.204	449.75	449.75
34	2.10377	925.638	16.2275	Final Cover	100	16	88.4111	218.799	414.301	0	414.301	440.032	440.032
35	2.10377	902.101	16.5354	Final Cover	100	16	87.0999	215.554	402.986	0	402.986	428.845	428.845
36	2.10377	875.457	16.8437	Final Cover	100	16	85.625	211.904	390.257	0	390.257	416.18	416.18
37	2.10377	845.69	17.1526	Final Cover	100	16	83.9857	207.847	376.109	0	376.109	402.03	402.03
38	2.10377	812.784	17.462	Final Cover	100	16	82.1815	203.382	360.537	0	360.537	386.389	386.389
39	2.10377	776.724	17.7719	Final Cover	100	16	80.2121	198.508	343.539	0	343.539	369.248	369.248
40	2.10377	737.494	18.0823	Final Cover	100	16	78.0766	193.223	325.107	0	325.107	350.6	350.6
41	2.10377	695.076	18.3933	Final Cover	100	16	75.7746	187.526	305.24	0	305.24	330.437	330.437
42	2.10377	649.454	18.7049	Final Cover	100	16	73.3055	181.416	283.931	0	283.931	308.75	308.75
43	2.10377	600.609	19.017	Final Cover	100	16	70.6689	174.891	261.175	0	261.175	285.532	285.532
44	2.10377	548.525	19.3297	Final Cover	100	16	67.8641	167.95	236.968	0	236.968	260.774	260.774
45	2.10377	493.182	19.6431	Final Cover	100	16	64.8906	160.59	211.304	0	211.304	234.466	234.466
46	2.10377	434.562	19.957	Final Cover	100	16	61.7475	152.812	184.178	0	184.178	206.6	206.6
47	2.10377	372.644	20.2716	Final Cover	100	16	58.4345	144.613	155.584	0	155.584	177.167	177.167
48	2.10377	307.409	20.5868	Final Cover	100	16	54.9506	135.991	125.517	0	125.517	146.157	146.157
49	2.10377	236.13	20.9026	Final Cover	100	16	51.1526	126.592	92.7374	0	92.7374	112.273	112.273
50	2.10377	89.8717	21.2191	Final Cover	100	16	43.4076	107.425	25.8934	0	25.8934	42.7468	42.7468

Query 1 (bishop simplified) - Safety Factor: 2.47479

Slice Number	Width [ft]	Weight [lbs]	Angle of Slice Base [deg]	Base Material	Base Cohesion [psf]	Base Friction Angle [deg]	Shear Stress [psf]	Shear Strength [psf]	Base Normal Stress [psf]	Pore Pressure [psf]	Effective Normal Stress [psf]	Base Vertical Stress [psf]	Effective Vertical Stress [psf]
1	2.10377	37.0869	6.27669	Final Cover	100	16	41.9167	103.735	13.0259	0	13.0259	17.6363	17.6363
2	2.10377	109.866	6.57393	Final Cover	100	16	45.8472	113.462	46.9483	0	46.9483	52.2319	52.2319
3	2.10377	179.852	6.87134	Final Cover	100	16	49.6212	122.802	79.5206	0	79.5206	85.5002	85.5002
4	2.10377	247.04	7.16895	Final Cover	100	16	53.2388	131.755	110.742	0	110.742	117.438	117.438
5	2.10377	311.425	7.46675	Final Cover	100	16	56.6998	140.32	140.613	0	140.613	148.044	148.044
6	2.10377	373.001	7.76475	Final Cover	100	16	60.0043	148.498	169.133	0	169.133	177.315	177.315
7	2.10377	431.763	8.06296	Final Cover	100	16	63.1522	156.288	196.301	0	196.301	205.247	205.247
8	2.10377	487.703	8.36139	Final Cover	100	16	66.1435	163.691	222.118	0	222.118	231.84	231.84
9	2.10377	540.817	8.66005	Final Cover	100	16	68.9781	170.706	246.582	0	246.582	257.088	257.088
10	2.10377	591.096	8.95895	Final Cover	100	16	71.6558	177.333	269.692	0	269.692	280.989	280.989
11	2.10377	638.535	9.2581	Final Cover	100	16	74.1766	183.572	291.449	0	291.449	303.54	303.54
12	2.10377	683.127	9.5575	Final Cover	100	16	76.5404	189.421	311.849	0	311.849	324.737	324.737
13	2.10377	724.863	9.85716	Final Cover	100	16	78.747	194.882	330.894	0	330.894	344.577	344.577
14	2.10377	763.736	10.1571	Final Cover	100	16	80.7964	199.954	348.581	0	348.581	363.056	363.056
15	2.10377	799.738	10.4573	Final Cover	100	16	82.6882	204.636	364.909	0	364.909	380.17	380.17
16	2.10377	832.861	10.7578	Final Cover	100	16	84.4225	208.928	379.876	0	379.876	395.917	395.917
17	2.10377	863.097	11.0586	Final Cover	100	16	85.9988	212.829	393.482	0	393.482	410.29	410.29
18	2.10377	890.436	11.3597	Final Cover	100	16	87.4171	216.339	405.724	0	405.724	423.287	423.287
19	2.10377	914.87	11.6612	Final Cover	100	16	88.6774	219.458	416.601	0	416.601	434.902	434.902
20	2.10377	936.389	11.9629	Final Cover	100	16	89.7793	222.185	426.11	0	426.11	445.132	445.132
21	2.10377	954.983	12.265	Final Cover	100	16	90.7224	224.519	434.249	0	434.249	453.972	453.972
22	2.10377	970.644	12.5675	Final Cover	100	16	91.5068	226.46	441.017	0	441.017	461.417	461.417
23	2.10377	983.359	12.8703	Final Cover	100	16	92.1315	228.006	446.412	0	446.412	467.462	467.462
24	2.10377	993.12	13.1735	Final Cover	100	16	92.5974	229.159	450.43	0	450.43	472.103	472.103
25	2.10377	999.914	13.477	Final Cover	100	16	92.9028	229.915	453.069	0	453.069	475.333	475.333
26	2.10377	1003.73	13.7809	Final Cover	100	16	93.0487	230.276	454.326	0	454.326	477.149	477.149
27	2.10377	1004.56	14.0853	Final Cover	100	16	93.0342	230.24	454.2	0	454.2	477.543	477.543
28	2.10377	1002.39	14.39	Final Cover	100	16	92.8588	229.806	452.687	0	452.687	476.512	476.512
29	2.10377	997.203	14.6951	Final Cover	100	16	92.5222	228.973	449.783	0	449.783	474.048	474.048
30	2.10377	988.993	15.0007	Final Cover	100	16	92.0244	227.741	445.487	0	445.487	470.146	470.146
31	2.10377	977.745	15.3067	Final Cover	100	16	91.3649	226.109	439.794	0	439.794	464.8	464.8
32	2.10377	963.445	15.6132	Final Cover	100	16	90.543	224.075	432.701	0	432.701	458.003	458.003
33	2.10377	946.081	15.9201	Final Cover	100	16	89.5587	221.639	424.204	0	424.204	449.75	449.75

34	2.10377	925.638	16.2275	Final Cover	100	16	88.4111	218.799	414.301	0	414.301	440.032	440.032
35	2.10377	902.101	16.5354	Final Cover	100	16	87.0999	215.554	402.986	0	402.986	428.845	428.845
36	2.10377	875.457	16.8437	Final Cover	100	16	85.625	211.904	390.257	0	390.257	416.18	416.18
37	2.10377	845.69	17.1526	Final Cover	100	16	83.9857	207.847	376.109	0	376.109	402.03	402.03
38	2.10377	812.784	17.462	Final Cover	100	16	82.1815	203.382	360.537	0	360.537	386.389	386.389
39	2.10377	776.724	17.7719	Final Cover	100	16	80.2121	198.508	343.539	0	343.539	369.248	369.248
40	2.10377	737.494	18.0823	Final Cover	100	16	78.0766	193.223	325.107	0	325.107	350.6	350.6
41	2.10377	695.076	18.3933	Final Cover	100	16	75.7746	187.526	305.24	0	305.24	330.437	330.437
42	2.10377	649.454	18.7049	Final Cover	100	16	73.3055	181.416	283.931	0	283.931	308.75	308.75
43	2.10377	600.609	19.017	Final Cover	100	16	70.6689	174.891	261.175	0	261.175	285.532	285.532
44	2.10377	548.525	19.3297	Final Cover	100	16	67.8641	167.95	236.968	0	236.968	260.774	260.774
45	2.10377	493.182	19.6431	Final Cover	100	16	64.8906	160.59	211.304	0	211.304	234.466	234.466
46	2.10377	434.562	19.957	Final Cover	100	16	61.7475	152.812	184.178	0	184.178	206.6	206.6
47	2.10377	372.644	20.2716	Final Cover	100	16	58.4345	144.613	155.584	0	155.584	177.167	177.167
48	2.10377	307.409	20.5868	Final Cover	100	16	54.9506	135.991	125.517	0	125.517	146.157	146.157
49	2.10377	236.13	20.9026	Final Cover	100	16	51.1526	126.592	92.7374	0	92.7374	112.273	112.273
50	2.10377	89.8717	21.2191	Final Cover	100	16	43.4076	107.425	25.8934	0	25.8934	42.7468	42.7468

◆ Simplified Janbu Method - Effective Stress

Global Minimum Query (janbu simplified) - Safety Factor: 2.09619

Slice Number	Width [ft]	Weight [lbs]	Angle of Slice Base [deg]	Base Material	Base Cohesion [psf]	Base Friction Angle [deg]	Shear Stress [psf]	Shear Strength [psf]	Base Normal Stress [psf]	Pore Pressure [psf]	Effective Normal Stress [psf]	Base Vertical Stress [psf]	Effective Vertical Stress [psf]
1	5.68302	1159.34	-19.2198	Final Cover	100	16	79.3906	166.418	231.627	0	231.627	203.949	203.949
2	6.5426	2806.18	11.111	Final Cover	100	16	103.599	217.164	408.601	0	408.601	428.947	428.947
3	3.2713	1470.21	14.1243	Final Cover	100	16	105.558	221.269	422.915	0	422.915	449.477	449.477
4	3.2713	1467.66	14.1243	Final Cover	100	16	105.455	221.053	422.162	0	422.162	448.698	448.698
5	7.08904	3231.66	13.0486	Final Cover	100	16	106.689	223.641	431.187	0	431.187	455.913	455.913
6	3.54452	1659.56	12.8124	Final Cover	100	16	108.387	227.2	443.601	0	443.601	468.25	468.25
7	3.54452	1693.07	12.8124	Final Cover	100	16	109.642	229.83	452.77	0	452.77	477.705	477.705
8	4.7737	2304.75	13.9388	Final Cover	100	16	110.022	230.626	455.547	0	455.547	482.853	482.853
9	4.7737	2308.74	13.9388	Final Cover	100	16	110.132	230.857	456.354	0	456.354	483.688	483.688
10	4.56118	2207.9	14.0152	Final Cover	100	16	110.168	230.933	456.616	0	456.616	484.115	484.115
11	4.56118	2208	14.0152	Final Cover	100	16	110.171	230.939	456.638	0	456.638	484.137	484.137
12	4.7924	2319.34	14.0428	Final Cover	100	16	110.147	230.889	456.462	0	456.462	484.012	484.012
13	4.7924	2318.04	14.0428	Final Cover	100	16	110.111	230.813	456.201	0	456.201	483.742	483.742
14	5.39247	2607.77	14.0107	Final Cover	100	16	110.107	230.805	456.172	0	456.172	483.647	483.647
15	5.18812	2509	14.0224	Final Cover	100	16	110.105	230.801	456.158	0	456.158	483.656	483.656
16	1.23119	595.356	14.0224	Final Cover	100	16	110.1	230.79	456.118	0	456.118	483.615	483.615
17	0.730512	353.229	14.0412	Final Cover	100	16	110.091	230.772	456.056	0	456.056	483.589	483.589
18	5.70006	2755.25	14.0412	Final Cover	100	16	110.069	230.726	455.896	0	455.896	483.424	483.424
19	6.43057	3107.08	14.0239	Final Cover	100	16	110.048	230.681	455.738	0	455.738	483.225	483.225
20	3.21529	1553.2	14.0341	Final Cover	100	16	110.031	230.646	455.617	0	455.617	483.12	483.12
21	3.21529	1552.82	14.0341	Final Cover	100	16	110.015	230.613	455.499	0	455.499	482.999	482.999
22	3.21529	1552.59	14.02	Final Cover	100	16	110.01	230.601	455.461	0	455.461	482.93	482.93
23	3.21529	1552.53	14.02	Final Cover	100	16	110.007	230.596	455.443	0	455.443	482.911	482.911
24	5.70779	2755.17	14.0403	Final Cover	100	16	109.981	230.542	455.252	0	455.252	482.756	482.756
25	5.70779	2753.51	14.0403	Final Cover	100	16	109.943	230.461	454.972	0	454.972	482.466	482.466
26	6.64089	3201.94	14.0326	Final Cover	100	16	109.911	230.394	454.735	0	454.735	482.206	482.206
27	3.32045	1600.41	14.0326	Final Cover	100	16	109.888	230.347	454.572	0	454.572	482.037	482.037
28	3.32045	1600.04	14.0326	Final Cover	100	16	109.874	230.316	454.464	0	454.464	481.925	481.925
29	3.32045	1599.86	14.0164	Final Cover	100	16	109.871	230.31	454.446	0	454.446	481.873	481.873
30	3.32045	1599.89	14.0164	Final Cover	100	16	109.872	230.312	454.452	0	454.452	481.88	481.88
31	6.12742	2952.43	14.0164	Final Cover	100	16	109.873	230.315	454.463	0	454.463	481.891	481.891
32	0.513472	247.412	14.0164	Final Cover	100	16	109.874	230.316	454.465	0	454.465	481.893	481.893

33	0.347453	167.414	14.0488	Final Cover	100	16	109.863	230.294	454.392	0	454.392	481.883	481.883
34	5.66945	2730.55	14.0488	Final Cover	100	16	109.836	230.237	454.192	0	454.192	481.676	481.676
35	5.99475	2884.79	14.0485	Final Cover	100	16	109.783	230.125	453.801	0	453.801	481.271	481.271
36	7.69368	3699.79	14.032	Final Cover	100	16	109.743	230.042	453.512	0	453.512	480.939	480.939
37	5.40377	2596.41	14.064	Final Cover	100	16	109.681	229.912	453.057	0	453.057	480.534	480.534
38	4.65832	2237.07	14.0113	Final Cover	100	16	109.662	229.872	452.919	0	452.919	480.284	480.284
39	5.17661	2486.92	13.9912	Final Cover	100	16	109.691	229.934	453.135	0	453.135	480.466	480.466
40	3.36264	1615.8	14.0311	Final Cover	100	16	109.694	229.939	453.152	0	453.152	480.565	480.565
41	3.36264	1615.45	14.0311	Final Cover	100	16	109.68	229.911	453.054	0	453.054	480.463	480.463
42	3.36264	1615.26	14.0193	Final Cover	100	16	109.676	229.901	453.019	0	453.019	480.404	480.404
43	3.36264	1615.21	14.0193	Final Cover	100	16	109.674	229.897	453.005	0	453.005	480.389	480.389
44	3.68436	1769.54	14.0285	Final Cover	100	16	109.664	229.877	452.936	0	452.936	480.337	480.337
45	3.68436	1769.21	14.0285	Final Cover	100	16	109.652	229.852	452.85	0	452.85	480.247	480.247
46	3.64631	1750.76	14.018	Final Cover	100	16	109.649	229.845	452.822	0	452.822	480.197	480.197
47	3.64631	1750.75	14.018	Final Cover	100	16	109.648	229.843	452.819	0	452.819	480.194	480.194
48	0.0760875	36.5325	14.018	Final Cover	100	16	109.648	229.843	452.815	0	452.815	480.19	480.19
49	3.13353	1150.27	40.3966	Final Cover	100	16	87.7276	183.894	292.571	0	292.571	367.224	367.224
50	3.13353	425.497	40.3966	Final Cover	100	16	59.3812	124.474	85.3523	0	85.3523	135.884	135.884

Query 1 (janbu simplified) - Safety Factor: 2.09619

Slice Number	Width [ft]	Weight [lbs]	Angle of Slice Base [deg]	Base Material	Base Cohesion [psf]	Base Friction Angle [deg]	Shear Stress [psf]	Shear Strength [psf]	Base Normal Stress [psf]	Pore Pressure [psf]	Effective Normal Stress [psf]	Base Vertical Stress [psf]	Effective Vertical Stress [psf]
1	5.68302	1159.34	-19.2198	Final Cover	100	16	79.3906	166.418	231.627	0	231.627	203.949	203.949
2	6.5426	2806.18	11.111	Final Cover	100	16	103.599	217.164	408.601	0	408.601	428.947	428.947
3	3.2713	1470.21	14.1243	Final Cover	100	16	105.558	221.269	422.915	0	422.915	449.477	449.477
4	3.2713	1467.66	14.1243	Final Cover	100	16	105.455	221.053	422.162	0	422.162	448.698	448.698
5	7.08904	3231.66	13.0486	Final Cover	100	16	106.689	223.641	431.187	0	431.187	455.913	455.913
6	3.54452	1659.56	12.8124	Final Cover	100	16	108.387	227.2	443.601	0	443.601	468.25	468.25
7	3.54452	1693.07	12.8124	Final Cover	100	16	109.642	229.83	452.77	0	452.77	477.705	477.705
8	4.7737	2304.75	13.9388	Final Cover	100	16	110.022	230.626	455.547	0	455.547	482.853	482.853
9	4.7737	2308.74	13.9388	Final Cover	100	16	110.132	230.857	456.354	0	456.354	483.688	483.688
10	4.56118	2207.9	14.0152	Final Cover	100	16	110.168	230.933	456.616	0	456.616	484.115	484.115
11	4.56118	2208	14.0152	Final Cover	100	16	110.171	230.939	456.638	0	456.638	484.137	484.137
12	4.7924	2319.34	14.0428	Final Cover	100	16	110.147	230.889	456.462	0	456.462	484.012	484.012
13	4.7924	2318.04	14.0428	Final Cover	100	16	110.111	230.813	456.201	0	456.201	483.742	483.742
14	5.39247	2607.77	14.0107	Final Cover	100	16	110.107	230.805	456.172	0	456.172	483.647	483.647
15	5.18812	2509	14.0224	Final Cover	100	16	110.105	230.801	456.158	0	456.158	483.656	483.656
16	1.23119	595.356	14.0224	Final Cover	100	16	110.1	230.79	456.118	0	456.118	483.615	483.615
17	0.730512	353.229	14.0412	Final Cover	100	16	110.091	230.772	456.056	0	456.056	483.589	483.589
18	5.70006	2755.25	14.0412	Final Cover	100	16	110.069	230.726	455.896	0	455.896	483.424	483.424
19	6.43057	3107.08	14.0239	Final Cover	100	16	110.048	230.681	455.738	0	455.738	483.225	483.225
20	3.21529	1553.2	14.0341	Final Cover	100	16	110.031	230.646	455.617	0	455.617	483.12	483.12
21	3.21529	1552.82	14.0341	Final Cover	100	16	110.015	230.613	455.499	0	455.499	482.999	482.999
22	3.21529	1552.59	14.02	Final Cover	100	16	110.01	230.601	455.461	0	455.461	482.93	482.93
23	3.21529	1552.53	14.02	Final Cover	100	16	110.007	230.596	455.443	0	455.443	482.911	482.911
24	5.70779	2755.17	14.0403	Final Cover	100	16	109.981	230.542	455.252	0	455.252	482.756	482.756
25	5.70779	2753.51	14.0403	Final Cover	100	16	109.943	230.461	454.972	0	454.972	482.466	482.466
26	6.64089	3201.94	14.0326	Final Cover	100	16	109.911	230.394	454.735	0	454.735	482.206	482.206
27	3.32045	1600.41	14.0326	Final Cover	100	16	109.888	230.347	454.572	0	454.572	482.037	482.037
28	3.32045	1600.04	14.0326	Final Cover	100	16	109.874	230.316	454.464	0	454.464	481.925	481.925
29	3.32045	1599.86	14.0164	Final Cover	100	16	109.871	230.31	454.446	0	454.446	481.873	481.873
30	3.32045	1599.89	14.0164	Final Cover	100	16	109.872	230.312	454.452	0	454.452	481.88	481.88
31	6.12742	2952.43	14.0164	Final Cover	100	16	109.873	230.315	454.463	0	454.463	481.891	481.891
32	0.513472	247.412	14.0164	Final Cover	100	16	109.874	230.316	454.465	0	454.465	481.893	481.893
33	0.347453	167.414	14.0488	Final Cover	100	16	109.863	230.294	454.392	0	454.392	481.883	481.883

34	5.66945	2730.55	14.0488	Final Cover	100	16	109.836	230.237	454.192	0	454.192	481.676	481.676
35	5.99475	2884.79	14.0485	Final Cover	100	16	109.783	230.125	453.801	0	453.801	481.271	481.271
36	7.69368	3699.79	14.032	Final Cover	100	16	109.743	230.042	453.512	0	453.512	480.939	480.939
37	5.40377	2596.41	14.064	Final Cover	100	16	109.681	229.912	453.057	0	453.057	480.534	480.534
38	4.65832	2237.07	14.0113	Final Cover	100	16	109.662	229.872	452.919	0	452.919	480.284	480.284
39	5.17661	2486.92	13.9912	Final Cover	100	16	109.691	229.934	453.135	0	453.135	480.466	480.466
40	3.36264	1615.8	14.0311	Final Cover	100	16	109.694	229.939	453.152	0	453.152	480.565	480.565
41	3.36264	1615.45	14.0311	Final Cover	100	16	109.68	229.911	453.054	0	453.054	480.463	480.463
42	3.36264	1615.26	14.0193	Final Cover	100	16	109.676	229.901	453.019	0	453.019	480.404	480.404
43	3.36264	1615.21	14.0193	Final Cover	100	16	109.674	229.897	453.005	0	453.005	480.389	480.389
44	3.68436	1769.54	14.0285	Final Cover	100	16	109.664	229.877	452.936	0	452.936	480.337	480.337
45	3.68436	1769.21	14.0285	Final Cover	100	16	109.652	229.852	452.85	0	452.85	480.247	480.247
46	3.64631	1750.76	14.018	Final Cover	100	16	109.649	229.845	452.822	0	452.822	480.197	480.197
47	3.64631	1750.75	14.018	Final Cover	100	16	109.648	229.843	452.819	0	452.819	480.194	480.194
48	0.0760875	36.5325	14.018	Final Cover	100	16	109.648	229.843	452.815	0	452.815	480.19	480.19
49	3.13353	1150.27	40.3966	Final Cover	100	16	87.7276	183.894	292.571	0	292.571	367.224	367.224
50	3.13353	425.497	40.3966	Final Cover	100	16	59.3812	124.474	85.3523	0	85.3523	135.884	135.884

Interslice Data

◆ Simplified Bishop Method - Effective Stress

Global Minimum Query (bishop simplified) - Safety Factor: 2.47479

Slice Number	X coordinate [ft]	Y coordinate - Bottom [ft]	Interslice Normal Force [lbs]	Interslice Shear Force [lbs]	Interslice Force Angle [deg]
1	200.091	27.8836	0	0	0
2	202.194	28.115	85.026	0	0
3	204.298	28.3574	169.939	0	0
4	206.402	28.6109	254.002	0	0
5	208.506	28.8755	336.519	0	0
6	210.609	29.1513	416.838	0	0
7	212.713	29.4381	494.351	0	0
8	214.817	29.7361	568.491	0	0
9	216.921	30.0453	638.735	0	0
10	219.025	30.3658	704.603	0	0
11	221.128	30.6974	765.66	0	0
12	223.232	31.0404	821.512	0	0
13	225.336	31.3946	871.811	0	0
14	227.44	31.7601	916.251	0	0
15	229.543	32.137	954.572	0	0
16	231.647	32.5253	986.556	0	0
17	233.751	32.925	1012.03	0	0
18	235.855	33.3362	1030.88	0	0
19	237.958	33.7588	1043	0	0
20	240.062	34.193	1048.37	0	0
21	242.166	34.6388	1047.01	0	0
22	244.27	35.0961	1038.95	0	0
23	246.373	35.5651	1024.31	0	0
24	248.477	36.0458	1003.24	0	0
25	250.581	36.5382	975.935	0	0
26	252.685	37.0424	942.637	0	0
27	254.789	37.5584	903.644	0	0
28	256.892	38.0862	859.297	0	0
29	258.996	38.626	809.989	0	0
30	261.1	39.1777	756.164	0	0
31	263.204	39.7414	698.313	0	0
32	265.307	40.3172	636.983	0	0
33	267.411	40.9051	572.769	0	0
34	269.515	41.5052	506.32	0	0
35	271.619	42.1175	438.34	0	0
36	273.722	42.7421	369.586	0	0
37	275.826	43.379	300.868	0	0
38	277.93	44.0283	233.054	0	0
39	280.034	44.6901	167.068	0	0
40	282.138	45.3644	103.892	0	0
41	284.241	46.0513	44.5641	0	0
42	286.345	46.7509	-9.81537	0	0
43	288.449	47.4631	-58.0874	0	0
44	290.553	48.1882	-99.0315	0	0
45	292.656	48.9262	-131.364	0	0
46	294.76	49.6771	-153.739	0	0
47	296.864	50.441	-164.745	0	0
48	298.968	51.218	-162.904	0	0
49	301.071	52.0082	-146.671	0	0
50	303.175	52.8117	-113.743	0	0
51	305.279	53.6285	0	0	0

Query 1 (bishop simplified) - Safety Factor: 2.47479

Slice Number	X coordinate [ft]	Y coordinate - Bottom [ft]	Interslice Normal Force [lbs]	Interslice Shear Force [lbs]	Interslice Force Angle [deg]
1	200.091	27.8836	0	0	0
2	202.194	28.115	85.026	0	0
3	204.298	28.3574	169.939	0	0
4	206.402	28.6109	254.002	0	0
5	208.506	28.8755	336.519	0	0
6	210.609	29.1513	416.838	0	0
7	212.713	29.4381	494.351	0	0
8	214.817	29.7361	568.491	0	0
9	216.921	30.0453	638.735	0	0
10	219.025	30.3658	704.603	0	0
11	221.128	30.6974	765.66	0	0
12	223.232	31.0404	821.512	0	0
13	225.336	31.3946	871.811	0	0
14	227.44	31.7601	916.251	0	0
15	229.543	32.137	954.572	0	0
16	231.647	32.5253	986.556	0	0
17	233.751	32.925	1012.03	0	0
18	235.855	33.3362	1030.88	0	0
19	237.958	33.7588	1043	0	0
20	240.062	34.193	1048.37	0	0
21	242.166	34.6388	1047.01	0	0
22	244.27	35.0961	1038.95	0	0
23	246.373	35.5651	1024.31	0	0
24	248.477	36.0458	1003.24	0	0
25	250.581	36.5382	975.935	0	0
26	252.685	37.0424	942.637	0	0
27	254.789	37.5584	903.644	0	0
28	256.892	38.0862	859.297	0	0
29	258.996	38.626	809.989	0	0
30	261.1	39.1777	756.164	0	0
31	263.204	39.7414	698.313	0	0
32	265.307	40.3172	636.983	0	0
33	267.411	40.9051	572.769	0	0
34	269.515	41.5052	506.32	0	0
35	271.619	42.1175	438.34	0	0
36	273.722	42.7421	369.586	0	0
37	275.826	43.379	300.868	0	0
38	277.93	44.0283	233.054	0	0
39	280.034	44.6901	167.068	0	0
40	282.138	45.3644	103.892	0	0
41	284.241	46.0513	44.5641	0	0
42	286.345	46.7509	-9.81537	0	0
43	288.449	47.4631	-58.0874	0	0
44	290.553	48.1882	-99.0315	0	0
45	292.656	48.9262	-131.364	0	0
46	294.76	49.6771	-153.739	0	0
47	296.864	50.441	-164.745	0	0
48	298.968	51.218	-162.904	0	0
49	301.071	52.0082	-146.671	0	0
50	303.175	52.8117	-113.743	0	0
51	305.279	53.6285	0	0	0

◆ Simplified Janbu Method - Effective Stress

Global Minimum Query (janbu simplified) - Safety Factor: 2.09619

Slice Number	X coordinate [ft]	Y coordinate - Bottom [ft]	Interslice Normal Force [lbs]	Interslice Shear Force [lbs]	Interslice Force Angle [deg]
1	97.7513	2.33455	0	0	0
2	103.434	0.353304	909.24	0	0
3	109.977	1.63821	1060.76	0	0
4	113.248	2.46138	1057.3	0	0
5	116.52	3.28455	1054.11	0	0
6	123.609	4.92752	1100.59	0	0
7	127.153	5.73362	1126.46	0	0
8	130.698	6.53972	1149.38	0	0
9	135.471	7.72452	1133.87	0	0
10	140.245	8.90932	1117.93	0	0
11	144.806	10.0478	1099.62	0	0
12	149.367	11.1864	1081.29	0	0
13	154.16	12.385	1061.02	0	0
14	158.952	13.5837	1040.88	0	0
15	164.345	14.9293	1019.71	0	0
16	169.533	16.225	998.829	0	0
17	170.764	16.5325	993.879	0	0
18	171.494	16.7152	990.832	0	0
19	177.195	18.1407	967.157	0	0
20	183.625	19.7469	941.503	0	0
21	186.84	20.5506	928.445	0	0
22	190.056	21.3543	915.43	0	0
23	193.271	22.1571	902.81	0	0
24	196.486	22.96	890.197	0	0
25	202.194	24.3874	866.951	0	0
26	207.902	25.8147	843.887	0	0
27	214.543	27.4745	817.662	0	0
28	217.863	28.3044	804.611	0	0
29	221.184	29.1343	791.601	0	0
30	224.504	29.9632	779.052	0	0
31	227.824	30.7921	766.501	0	0
32	233.952	32.3216	743.332	0	0
33	234.465	32.4498	741.39	0	0
34	234.813	32.5368	739.984	0	0
35	240.482	33.9554	717.173	0	0
36	246.477	35.4555	693.334	0	0
37	254.171	37.3783	664.062	0	0
38	259.574	38.732	642.325	0	0
39	264.233	39.8945	625.721	0	0
40	269.409	41.1843	608.02	0	0
41	272.772	42.0246	595.388	0	0
42	276.135	42.865	582.794	0	0
43	279.497	43.7046	570.545	0	0
44	282.86	44.5442	558.3	0	0
45	286.544	45.4647	544.63	0	0
46	290.229	46.3853	530.997	0	0
47	293.875	47.2956	517.836	0	0
48	297.521	48.206	504.678	0	0
49	297.597	48.225	504.403	0	0
50	300.731	50.8915	-1.36486	0	0
51	303.864	53.558	0	0	0

Query 1 (janbu simplified) - Safety Factor: 2.09619

Slice Number	X coordinate [ft]	Y coordinate - Bottom [ft]	Interslice Normal Force [lbs]	Interslice Shear Force [lbs]	Interslice Force Angle [deg]
1	97.7513	2.33455	0	0	0
2	103.434	0.353304	909.24	0	0
3	109.977	1.63821	1060.76	0	0
4	113.248	2.46138	1057.3	0	0
5	116.52	3.28455	1054.11	0	0
6	123.609	4.92752	1100.59	0	0
7	127.153	5.73362	1126.46	0	0
8	130.698	6.53972	1149.38	0	0
9	135.471	7.72452	1133.87	0	0
10	140.245	8.90932	1117.93	0	0
11	144.806	10.0478	1099.62	0	0
12	149.367	11.1864	1081.29	0	0
13	154.16	12.385	1061.02	0	0
14	158.952	13.5837	1040.88	0	0
15	164.345	14.9293	1019.71	0	0
16	169.533	16.225	998.829	0	0
17	170.764	16.5325	993.879	0	0
18	171.494	16.7152	990.832	0	0
19	177.195	18.1407	967.157	0	0
20	183.625	19.7469	941.503	0	0
21	186.84	20.5506	928.445	0	0
22	190.056	21.3543	915.43	0	0
23	193.271	22.1571	902.81	0	0
24	196.486	22.96	890.197	0	0
25	202.194	24.3874	866.951	0	0
26	207.902	25.8147	843.887	0	0
27	214.543	27.4745	817.662	0	0
28	217.863	28.3044	804.611	0	0
29	221.184	29.1343	791.601	0	0
30	224.504	29.9632	779.052	0	0
31	227.824	30.7921	766.501	0	0
32	233.952	32.3216	743.332	0	0
33	234.465	32.4498	741.39	0	0
34	234.813	32.5368	739.984	0	0
35	240.482	33.9554	717.173	0	0
36	246.477	35.4555	693.334	0	0
37	254.171	37.3783	664.062	0	0
38	259.574	38.732	642.325	0	0
39	264.233	39.8945	625.721	0	0
40	269.409	41.1843	608.02	0	0
41	272.772	42.0246	595.388	0	0
42	276.135	42.865	582.794	0	0
43	279.497	43.7046	570.545	0	0
44	282.86	44.5442	558.3	0	0
45	286.544	45.4647	544.63	0	0
46	290.229	46.3853	530.997	0	0
47	293.875	47.2956	517.836	0	0
48	297.521	48.206	504.678	0	0
49	297.597	48.225	504.403	0	0
50	300.731	50.8915	-1.36486	0	0
51	303.864	53.558	0	0	0

Discharge Sections

Entity Information

◆ Simplified Bishop Method - Effective Stress

Shared Entities

Type	Coordinates (x,y)
External Boundary	0, 0 0, -11 0, -30.6081 0, -200 600, -200 600, -38.5 600, -34.5 600, 34.5 600, 63.5 600, 67.5 583.7, 67.5 302.7, 53.5 88.4, 0
Material Boundary	101, 0 134.147, -11 213.7, -37.4 600, -34.5
Material Boundary	88.4, 0 121.692, -11 181.037, -30.6081 213.7, -41.4 600, -38.5
Material Boundary	88.4, 0 101, 0 104.6, 0 302.7, 49.5 582.7, 63.5 600, 63.5
Material Boundary	0, -11 121.692, -11

◆ Simplified Janbu Method - Effective Stress

Shared Entities

Type	Coordinates (x,y)
External Boundary	0, 0 0, -11 0, -30.6081 0, -200 600, -200 600, -38.5 600, -34.5 600, 34.5 600, 63.5 600, 67.5 583.7, 67.5 302.7, 53.5 88.4, 0
Material Boundary	101, 0 134.147, -11 213.7, -37.4 600, -34.5
Material Boundary	88.4, 0 121.692, -11 181.037, -30.6081 213.7, -41.4 600, -38.5
Material Boundary	88.4, 0 101, 0 104.6, 0 302.7, 49.5 582.7, 63.5 600, 63.5
Material Boundary	0, -11 121.692, -11

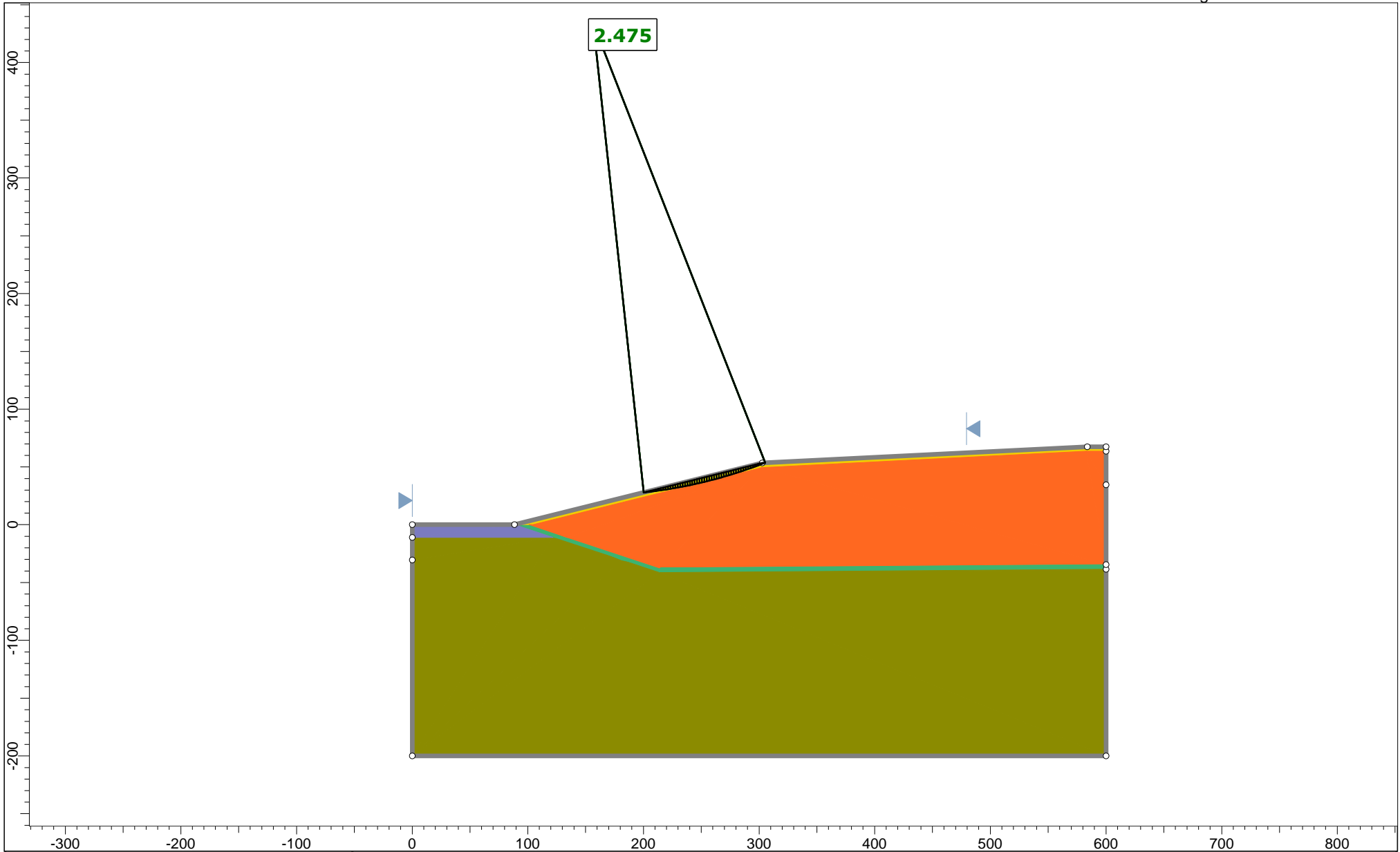

	<i>Project</i> SLIDE - An Interactive Slope Stability Program	
	<i>Group</i> Simplified Bishop Method - Total Stress	<i>Scenario</i> Master Scenario
	<i>Drawn By</i>	<i>Company</i>
	<i>Date</i>	<i>File Name</i> Slide2-FC Section C_Total Stress.slmd

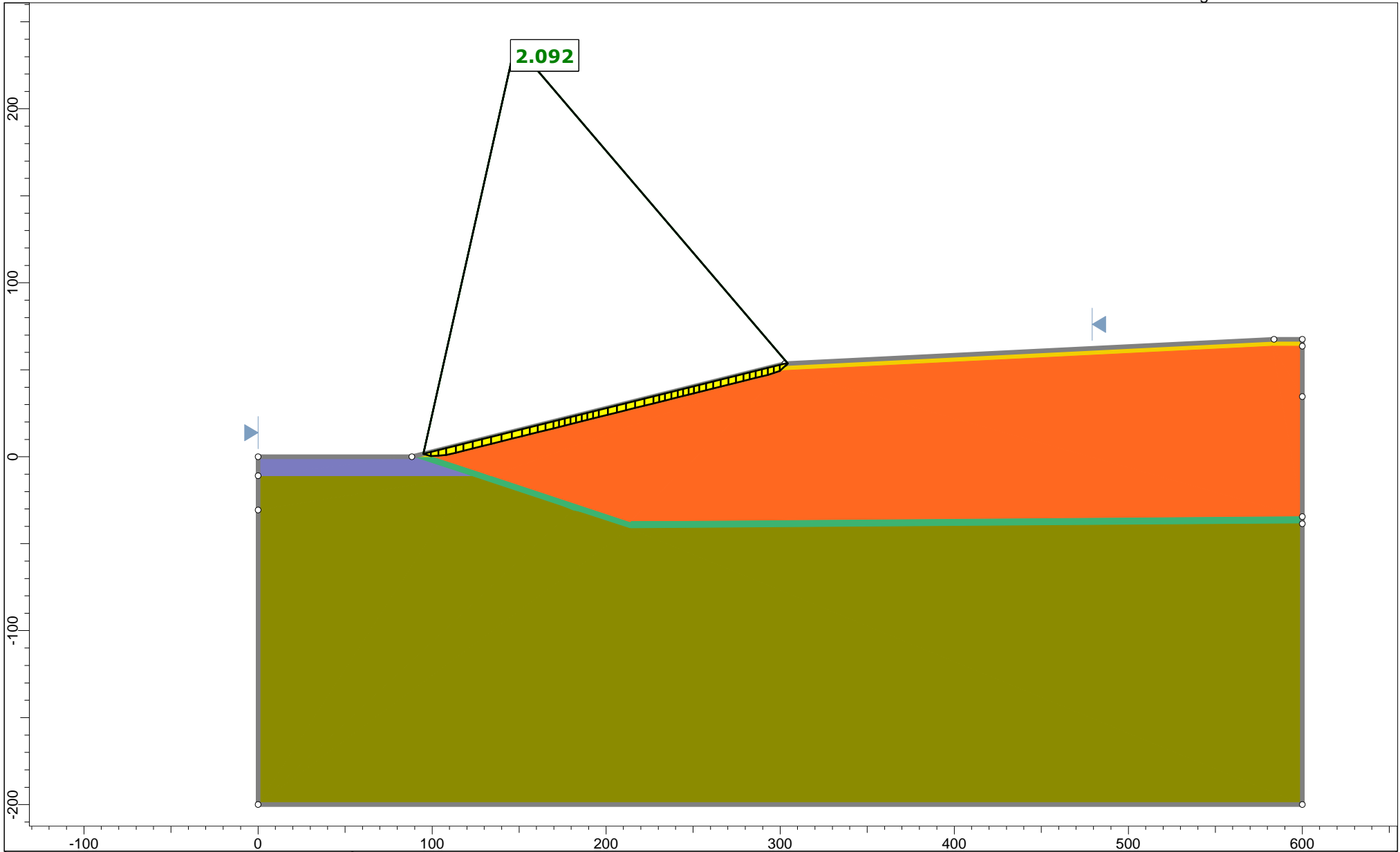

SLIDEINTERPRET 9.018

Project	SLIDE - An Interactive Slope Stability Program		
Group	Simplified Janbu Method -Total Stress	Scenario	Master Scenario
Drawn By		Company	
Date		File Name	Slide2-FC Section C_Total Stress.slmd

Materials

Final Cover

Color	
Strength Type	Mohr-Coulomb
Unit Weight [lbs/ft ³]	120
Cohesion [psf]	100
Friction Angle [deg]	16
Water Surface	Assigned per scenario
Ru Value	0

Liner

Color	
Strength Type	Mohr-Coulomb
Unit Weight [lbs/ft ³]	116
Cohesion [psf]	1000
Friction Angle [deg]	0
Water Surface	Assigned per scenario
Ru Value	0

Waste

Color	
Strength Type	Mohr-Coulomb
Unit Weight [lbs/ft ³]	47
Cohesion [psf]	288
Friction Angle [deg]	23
Water Surface	Assigned per scenario
Ru Value	0





Stratum II

Color	
Strength Type	Mohr-Coulomb
Unit Weight [lbs/ft ³]	110.9
Cohesion [psf]	206
Friction Angle [deg]	26
Water Surface	Assigned per scenario
Ru Value	0

Stratum III

Color	
Strength Type	Mohr-Coulomb
Unit Weight [lbs/ft ³]	109.7
Cohesion [psf]	150
Friction Angle [deg]	24
Water Surface	Assigned per scenario
Ru Value	0

Materials In Use

Material		Simplified Bishop Method - Total Stress	Simplified Janbu Method - Total Stress
Final Cover		✓	✓
Liner		✓	✓
Waste		✓	✓
Stratum II		✓	✓
Stratum III		✓	✓

Global Minimums

◆ Simplified Bishop Method - Total Stress

Method: bishop simplified

FS	2.474790
Center:	156.527, 433.638
Radius:	408.086
Left Slip Surface Endpoint:	200.091, 27.884
Right Slip Surface Endpoint:	305.279, 53.628
Resisting Moment:	8.35479e+06 lb-ft
Driving Moment:	3.37595e+06 lb-ft
Total Slice Area:	287.057 ft ²
Surface Horizontal Width:	105.188 ft
Surface Average Height:	2.72898 ft

◆ Simplified Janbu Method -Total Stress

Method: janbu simplified

FS	2.091650
Axis Location:	147.713, 236.938
Left Slip Surface Endpoint:	94.986, 1.644
Right Slip Surface Endpoint:	304.312, 53.580
Resisting Horizontal Force:	47166.8 lb
Driving Horizontal Force:	22551.4 lb
Total Slice Area:	808.795 ft ²
Surface Horizontal Width:	209.326 ft
Surface Average Height:	3.8638 ft

Global Minimum Coordinates

◆ Simplified Janbu Method -Total Stress

Method: janbu simplified

X	Y
94.9862	1.64424
99.2463	0.28007
103.649	0.620349
108.051	0.960628
113.656	2.2954
117.928	3.35967
128.703	6.04447
133.887	7.33681
139.866	8.82912
145.845	10.3214
151.654	11.772
160.657	14.0202
169.661	16.2684
176.178	17.8958
182.695	19.5231
189.212	21.1505
195.729	22.7778
206.135	25.3763
216.659	28.0041
227.191	30.6341
233.8	32.2844
241.154	34.1218
247.318	35.662
253.442	37.1923
261.433	39.1893
270.185	41.3763
278.951	43.5669
285.922	45.3092
292.884	47.0489
299.726	49.312
304.312	53.5803

Valid and Invalid Surfaces

◆ Simplified Bishop Method - Total Stress

Method: bishop simplified

Number of Valid Surfaces:	11996
Number of Invalid Surfaces:	0

◆ Simplified Janbu Method -Total Stress

Method: janbu simplified

Number of Valid Surfaces:	23721
Number of Invalid Surfaces:	1349

Error Codes

Error Code -106 reported for 9 surfaces
 Error Code -108 reported for 46 surfaces
 Error Code -111 reported for 492 surfaces
 Error Code -112 reported for 356 surfaces
 Error Code -121 reported for 97 surfaces
 Error Code -124 reported for 1 surface
 Error Code -145 reported for 71 surfaces
 Error Code -1000 reported for 277 surfaces

Error Code Descriptions

The following errors were encountered during the computation:

- 106 = Average slice width is less than $0.0001 * (\text{maximum horizontal extent of soil region})$. This limitation is imposed to avoid numerical errors which may result from too many slices, or too small a slip region.
- 108 = Total driving moment or total driving force < 0.1 . This is to limit the calculation of extremely high safety factors if the driving force is very small (0.1 is an arbitrary number).
- 111 = Safety factor equation did not converge
- 112 = The coefficient $M\text{-Alpha} = \cos(\alpha)(1 + \tan(\alpha)\tan(\phi)/F) < 0.2$ for the final iteration of the safety factor calculation. This screens out some slip surfaces which may not be valid in the context of the analysis, in particular, deep seated slip surfaces with many high negative base angle slices in the passive zone.
- 121 = Concave failure surface, only convex surfaces have been defined as being allowed.
- 124 = A slice has a width less than the minimum acceptable value.
- 145 = Slip surface was clipped vertically by a weak layer in a region of compression. Such a surface cannot be evaluated using Limit Equilibrium. For more information, see Help Documentation on weak layers.
- 1000 = No valid slip surface is generated

Slice Data

◆ Simplified Bishop Method - Total Stress

Global Minimum Query (bishop simplified) - Safety Factor: 2.47479

Slice Number	Width [ft]	Weight [lbs]	Angle of Slice Base [deg]	Base Material	Base Cohesion [psf]	Base Friction Angle [deg]	Shear Stress [psf]	Shear Strength [psf]	Base Normal Stress [psf]	Pore Pressure [psf]	Effective Normal Stress [psf]	Base Vertical Stress [psf]	Effective Vertical Stress [psf]
1	2.10377	37.0869	6.27669	Final Cover	100	16	41.9167	103.735	13.0259	0	13.0259	17.6363	17.6363
2	2.10377	109.866	6.57393	Final Cover	100	16	45.8472	113.462	46.9483	0	46.9483	52.2319	52.2319
3	2.10377	179.852	6.87134	Final Cover	100	16	49.6212	122.802	79.5206	0	79.5206	85.5002	85.5002
4	2.10377	247.04	7.16895	Final Cover	100	16	53.2388	131.755	110.742	0	110.742	117.438	117.438
5	2.10377	311.425	7.46675	Final Cover	100	16	56.6998	140.32	140.613	0	140.613	148.044	148.044
6	2.10377	373.001	7.76475	Final Cover	100	16	60.0043	148.498	169.133	0	169.133	177.315	177.315
7	2.10377	431.763	8.06296	Final Cover	100	16	63.1522	156.288	196.301	0	196.301	205.247	205.247
8	2.10377	487.703	8.36139	Final Cover	100	16	66.1435	163.691	222.118	0	222.118	231.84	231.84
9	2.10377	540.817	8.66005	Final Cover	100	16	68.9781	170.706	246.582	0	246.582	257.088	257.088
10	2.10377	591.096	8.95895	Final Cover	100	16	71.6558	177.333	269.692	0	269.692	280.989	280.989
11	2.10377	638.535	9.2581	Final Cover	100	16	74.1766	183.572	291.449	0	291.449	303.54	303.54
12	2.10377	683.127	9.5575	Final Cover	100	16	76.5404	189.421	311.849	0	311.849	324.737	324.737
13	2.10377	724.863	9.85716	Final Cover	100	16	78.747	194.882	330.894	0	330.894	344.577	344.577
14	2.10377	763.736	10.1571	Final Cover	100	16	80.7964	199.954	348.581	0	348.581	363.056	363.056
15	2.10377	799.738	10.4573	Final Cover	100	16	82.6882	204.636	364.909	0	364.909	380.17	380.17
16	2.10377	832.861	10.7578	Final Cover	100	16	84.4225	208.928	379.876	0	379.876	395.917	395.917
17	2.10377	863.097	11.0586	Final Cover	100	16	85.9988	212.829	393.482	0	393.482	410.29	410.29
18	2.10377	890.436	11.3597	Final Cover	100	16	87.4171	216.339	405.724	0	405.724	423.287	423.287
19	2.10377	914.87	11.6612	Final Cover	100	16	88.6774	219.458	416.601	0	416.601	434.902	434.902
20	2.10377	936.389	11.9629	Final Cover	100	16	89.7793	222.185	426.11	0	426.11	445.132	445.132
21	2.10377	954.983	12.265	Final Cover	100	16	90.7224	224.519	434.249	0	434.249	453.972	453.972
22	2.10377	970.644	12.5675	Final Cover	100	16	91.5068	226.46	441.017	0	441.017	461.417	461.417
23	2.10377	983.359	12.8703	Final Cover	100	16	92.1315	228.006	446.412	0	446.412	467.462	467.462
24	2.10377	993.12	13.1735	Final Cover	100	16	92.5974	229.159	450.43	0	450.43	472.103	472.103
25	2.10377	999.914	13.477	Final Cover	100	16	92.9028	229.915	453.069	0	453.069	475.333	475.333
26	2.10377	1003.73	13.7809	Final Cover	100	16	93.0487	230.276	454.326	0	454.326	477.149	477.149
27	2.10377	1004.56	14.0853	Final Cover	100	16	93.0342	230.24	454.2	0	454.2	477.543	477.543
28	2.10377	1002.39	14.39	Final Cover	100	16	92.8588	229.806	452.687	0	452.687	476.512	476.512
29	2.10377	997.203	14.6951	Final Cover	100	16	92.5222	228.973	449.783	0	449.783	474.048	474.048

Slide2-FC Section C_Total Stress

Permit Page - IILL-1872

30	2.10377	988.993	15.0007	Final Cover	100	16	92.0244	227.741	445.487	0	445.487	470.146	470.146
31	2.10377	977.745	15.3067	Final Cover	100	16	91.3649	226.109	439.794	0	439.794	464.8	464.8
32	2.10377	963.445	15.6132	Final Cover	100	16	90.543	224.075	432.701	0	432.701	458.003	458.003
33	2.10377	946.081	15.9201	Final Cover	100	16	89.5587	221.639	424.204	0	424.204	449.75	449.75
34	2.10377	925.638	16.2275	Final Cover	100	16	88.4111	218.799	414.301	0	414.301	440.032	440.032
35	2.10377	902.101	16.5354	Final Cover	100	16	87.0999	215.554	402.986	0	402.986	428.845	428.845
36	2.10377	875.457	16.8437	Final Cover	100	16	85.625	211.904	390.257	0	390.257	416.18	416.18
37	2.10377	845.69	17.1526	Final Cover	100	16	83.9857	207.847	376.109	0	376.109	402.03	402.03
38	2.10377	812.784	17.462	Final Cover	100	16	82.1815	203.382	360.537	0	360.537	386.389	386.389
39	2.10377	776.724	17.7719	Final Cover	100	16	80.2121	198.508	343.539	0	343.539	369.248	369.248
40	2.10377	737.494	18.0823	Final Cover	100	16	78.0766	193.223	325.107	0	325.107	350.6	350.6
41	2.10377	695.076	18.3933	Final Cover	100	16	75.7746	187.526	305.24	0	305.24	330.437	330.437
42	2.10377	649.454	18.7049	Final Cover	100	16	73.3055	181.416	283.931	0	283.931	308.75	308.75
43	2.10377	600.609	19.017	Final Cover	100	16	70.6689	174.891	261.175	0	261.175	285.532	285.532
44	2.10377	548.525	19.3297	Final Cover	100	16	67.8641	167.95	236.968	0	236.968	260.774	260.774
45	2.10377	493.182	19.6431	Final Cover	100	16	64.8906	160.59	211.304	0	211.304	234.466	234.466
46	2.10377	434.562	19.957	Final Cover	100	16	61.7475	152.812	184.178	0	184.178	206.6	206.6
47	2.10377	372.644	20.2716	Final Cover	100	16	58.4345	144.613	155.584	0	155.584	177.167	177.167
48	2.10377	307.409	20.5868	Final Cover	100	16	54.9506	135.991	125.517	0	125.517	146.157	146.157
49	2.10377	236.13	20.9026	Final Cover	100	16	51.1526	126.592	92.7374	0	92.7374	112.273	112.273
50	2.10377	89.8717	21.2191	Final Cover	100	16	43.4076	107.425	25.8934	0	25.8934	42.7468	42.7468

Query 1 (bishop simplified) - Safety Factor: 2.47479

Slice Number	Width [ft]	Weight [lbs]	Angle of Slice Base [deg]	Base Material	Base Cohesion [psf]	Base Friction Angle [deg]	Shear Stress [psf]	Shear Strength [psf]	Base Normal Stress [psf]	Pore Pressure [psf]	Effective Normal Stress [psf]	Base Vertical Stress [psf]	Effective Vertical Stress [psf]
1	2.10377	37.0869	6.27669	Final Cover	100	16	41.9167	103.735	13.0259	0	13.0259	17.6363	17.6363
2	2.10377	109.866	6.57393	Final Cover	100	16	45.8472	113.462	46.9483	0	46.9483	52.2319	52.2319
3	2.10377	179.852	6.87134	Final Cover	100	16	49.6212	122.802	79.5206	0	79.5206	85.5002	85.5002
4	2.10377	247.04	7.16895	Final Cover	100	16	53.2388	131.755	110.742	0	110.742	117.438	117.438
5	2.10377	311.425	7.46675	Final Cover	100	16	56.6998	140.32	140.613	0	140.613	148.044	148.044
6	2.10377	373.001	7.76475	Final Cover	100	16	60.0043	148.498	169.133	0	169.133	177.315	177.315
7	2.10377	431.763	8.06296	Final Cover	100	16	63.1522	156.288	196.301	0	196.301	205.247	205.247
8	2.10377	487.703	8.36139	Final Cover	100	16	66.1435	163.691	222.118	0	222.118	231.84	231.84
9	2.10377	540.817	8.66005	Final Cover	100	16	68.9781	170.706	246.582	0	246.582	257.088	257.088
10	2.10377	591.096	8.95895	Final Cover	100	16	71.6558	177.333	269.692	0	269.692	280.989	280.989
11	2.10377	638.535	9.2581	Final Cover	100	16	74.1766	183.572	291.449	0	291.449	303.54	303.54
12	2.10377	683.127	9.5575	Final Cover	100	16	76.5404	189.421	311.849	0	311.849	324.737	324.737
13	2.10377	724.863	9.85716	Final Cover	100	16	78.747	194.882	330.894	0	330.894	344.577	344.577
14	2.10377	763.736	10.1571	Final Cover	100	16	80.7964	199.954	348.581	0	348.581	363.056	363.056
15	2.10377	799.738	10.4573	Final Cover	100	16	82.6882	204.636	364.909	0	364.909	380.17	380.17
16	2.10377	832.861	10.7578	Final Cover	100	16	84.4225	208.928	379.876	0	379.876	395.917	395.917
17	2.10377	863.097	11.0586	Final Cover	100	16	85.9988	212.829	393.482	0	393.482	410.29	410.29
18	2.10377	890.436	11.3597	Final Cover	100	16	87.4171	216.339	405.724	0	405.724	423.287	423.287
19	2.10377	914.87	11.6612	Final Cover	100	16	88.6774	219.458	416.601	0	416.601	434.902	434.902
20	2.10377	936.389	11.9629	Final Cover	100	16	89.7793	222.185	426.11	0	426.11	445.132	445.132
21	2.10377	954.983	12.265	Final Cover	100	16	90.7224	224.519	434.249	0	434.249	453.972	453.972
22	2.10377	970.644	12.5675	Final Cover	100	16	91.5068	226.46	441.017	0	441.017	461.417	461.417
23	2.10377	983.359	12.8703	Final Cover	100	16	92.1315	228.006	446.412	0	446.412	467.462	467.462
24	2.10377	993.12	13.1735	Final Cover	100	16	92.5974	229.159	450.43	0	450.43	472.103	472.103
25	2.10377	999.914	13.477	Final Cover	100	16	92.9028	229.915	453.069	0	453.069	475.333	475.333
26	2.10377	1003.73	13.7809	Final Cover	100	16	93.0487	230.276	454.326	0	454.326	477.149	477.149
27	2.10377	1004.56	14.0853	Final Cover	100	16	93.0342	230.24	454.2	0	454.2	477.543	477.543
28	2.10377	1002.39	14.39	Final Cover	100	16	92.8588	229.806	452.687	0	452.687	476.512	476.512
29	2.10377	997.203	14.6951	Final Cover	100	16	92.5222	228.973	449.783	0	449.783	474.048	474.048
30	2.10377	988.993	15.0007	Final Cover	100	16	92.0244	227.741	445.487	0	445.487	470.146	470.146
31	2.10377	977.745	15.3067	Final Cover	100	16	91.3649	226.109	439.794	0	439.794	464.8	464.8
32	2.10377	963.445	15.6132	Final Cover	100	16	90.543	224.075	432.701	0	432.701	458.003	458.003
33	2.10377	946.081	15.9201	Final Cover	100	16	89.5587	221.639	424.204	0	424.204	449.75	449.75

Slide2-FC Section C_Total Stress

Permit Page - IILL-1874

34	2.10377	925.638	16.2275	Final Cover	100	16	88.4111	218.799	414.301	0	414.301	440.032	440.032
35	2.10377	902.101	16.5354	Final Cover	100	16	87.0999	215.554	402.986	0	402.986	428.845	428.845
36	2.10377	875.457	16.8437	Final Cover	100	16	85.625	211.904	390.257	0	390.257	416.18	416.18
37	2.10377	845.69	17.1526	Final Cover	100	16	83.9857	207.847	376.109	0	376.109	402.03	402.03
38	2.10377	812.784	17.462	Final Cover	100	16	82.1815	203.382	360.537	0	360.537	386.389	386.389
39	2.10377	776.724	17.7719	Final Cover	100	16	80.2121	198.508	343.539	0	343.539	369.248	369.248
40	2.10377	737.494	18.0823	Final Cover	100	16	78.0766	193.223	325.107	0	325.107	350.6	350.6
41	2.10377	695.076	18.3933	Final Cover	100	16	75.7746	187.526	305.24	0	305.24	330.437	330.437
42	2.10377	649.454	18.7049	Final Cover	100	16	73.3055	181.416	283.931	0	283.931	308.75	308.75
43	2.10377	600.609	19.017	Final Cover	100	16	70.6689	174.891	261.175	0	261.175	285.532	285.532
44	2.10377	548.525	19.3297	Final Cover	100	16	67.8641	167.95	236.968	0	236.968	260.774	260.774
45	2.10377	493.182	19.6431	Final Cover	100	16	64.8906	160.59	211.304	0	211.304	234.466	234.466
46	2.10377	434.562	19.957	Final Cover	100	16	61.7475	152.812	184.178	0	184.178	206.6	206.6
47	2.10377	372.644	20.2716	Final Cover	100	16	58.4345	144.613	155.584	0	155.584	177.167	177.167
48	2.10377	307.409	20.5868	Final Cover	100	16	54.9506	135.991	125.517	0	125.517	146.157	146.157
49	2.10377	236.13	20.9026	Final Cover	100	16	51.1526	126.592	92.7374	0	92.7374	112.273	112.273
50	2.10377	89.8717	21.2191	Final Cover	100	16	43.4076	107.425	25.8934	0	25.8934	42.7468	42.7468

◆ Simplified Janbu Method -Total Stress

Global Minimum Query (janbu simplified) - Safety Factor: 2.09165

Slice Number	Width [ft]	Weight [lbs]	Angle of Slice Base [deg]	Base Material	Base Cohesion [psf]	Base Friction Angle [deg]	Shear Stress [psf]	Shear Strength [psf]	Base Normal Stress [psf]	Pore Pressure [psf]	Effective Normal Stress [psf]	Base Vertical Stress [psf]	Effective Vertical Stress [psf]
1	4.2601	620.536	-17.7561	Final Cover	100	16	70.8849	148.266	168.325	0	168.325	145.626	145.626
2	4.40251	1483	4.41972	Final Cover	100	16	93.0046	194.533	329.676	0	329.676	336.865	336.865
3	4.40251	1883.88	4.41972	Final Cover	100	16	105.357	220.37	419.778	0	419.778	427.922	427.922
4	5.60493	2675.28	13.3951	Final Cover	100	16	109.669	229.389	451.232	0	451.232	477.349	477.349
5	4.27206	2056.2	13.989	Final Cover	100	16	110.04	230.166	453.942	0	453.942	481.356	481.356
6	5.38724	2594.49	13.9921	Final Cover	100	16	110.078	230.244	454.214	0	454.214	481.643	481.643
7	5.38724	2596.12	13.9921	Final Cover	100	16	110.118	230.328	454.507	0	454.507	481.947	481.947
8	5.18467	2499.91	13.9965	Final Cover	100	16	110.153	230.401	454.761	0	454.761	482.218	482.218
9	5.97866	2883.57	14.015	Final Cover	100	16	110.166	230.428	454.857	0	454.857	482.355	482.355
10	5.97866	2883.76	14.015	Final Cover	100	16	110.17	230.437	454.888	0	454.888	482.387	482.387
11	5.80911	2801.96	14.0204	Final Cover	100	16	110.168	230.433	454.874	0	454.874	482.384	482.384
12	4.50173	2171.21	14.0204	Final Cover	100	16	110.163	230.423	454.841	0	454.841	482.349	482.349
13	4.50173	2171.07	14.0204	Final Cover	100	16	110.159	230.415	454.81	0	454.81	482.318	482.318
14	4.50173	2170.93	14.0204	Final Cover	100	16	110.156	230.407	454.782	0	454.782	482.289	482.289
15	4.50173	2170.8	14.0204	Final Cover	100	16	110.151	230.398	454.752	0	454.752	482.258	482.258
16	3.25854	1571.23	14.0204	Final Cover	100	16	110.148	230.391	454.726	0	454.726	482.231	482.231
17	3.25854	1571.16	14.0204	Final Cover	100	16	110.145	230.385	454.706	0	454.706	482.209	482.209
18	3.25854	1571.09	14.0204	Final Cover	100	16	110.142	230.379	454.685	0	454.685	482.188	482.188
19	3.25854	1571.01	14.0204	Final Cover	100	16	110.139	230.373	454.664	0	454.664	482.166	482.166
20	3.25853	1570.94	14.0204	Final Cover	100	16	110.136	230.367	454.644	0	454.644	482.146	482.146
21	3.25853	1570.87	14.0204	Final Cover	100	16	110.134	230.361	454.623	0	454.623	482.124	482.124
22	3.25853	1570.8	14.0204	Final Cover	100	16	110.131	230.355	454.602	0	454.602	482.102	482.102
23	3.25853	1570.73	14.0204	Final Cover	100	16	110.128	230.349	454.578	0	454.578	482.078	482.078
24	5.20312	2507.94	14.0204	Final Cover	100	16	110.124	230.341	454.552	0	454.552	482.051	482.051
25	5.20312	2507.76	14.0204	Final Cover	100	16	110.119	230.331	454.519	0	454.519	482.016	482.016
26	5.26183	2535.87	14.0204	Final Cover	100	16	110.115	230.321	454.485	0	454.485	481.981	481.981
27	5.26183	2535.68	14.0204	Final Cover	100	16	110.11	230.311	454.45	0	454.45	481.945	481.945
28	5.266	2537.51	14.0204	Final Cover	100	16	110.105	230.302	454.416	0	454.416	481.91	481.91
29	5.266	2537.32	14.0204	Final Cover	100	16	110.101	230.292	454.383	0	454.383	481.875	481.875
30	3.3046	1592.16	14.0205	Final Cover	100	16	110.097	230.284	454.354	0	454.354	481.846	481.846
31	3.3046	1592.08	14.0205	Final Cover	100	16	110.093	230.277	454.331	0	454.331	481.822	481.822
32	3.67714	1771.37	14.0277	Final Cover	100	16	110.084	230.258	454.264	0	454.264	481.768	481.768

Slide2-FC Section C_Total Stress

Permit Page - IILL-1876

33	3.67714	1771.06	14.0277	Final Cover	100	16	110.073	230.235	454.183	0	454.183	481.684	481.684
34	3.08175	1484.03	14.0303	Final Cover	100	16	110.061	230.209	454.095	0	454.095	481.598	481.598
35	3.08175	1483.75	14.0303	Final Cover	100	16	110.049	230.185	454.007	0	454.007	481.507	481.507
36	3.06195	1473.95	14.0303	Final Cover	100	16	110.038	230.16	453.921	0	453.921	481.418	481.418
37	3.06195	1473.68	14.0303	Final Cover	100	16	110.026	230.136	453.839	0	453.839	481.333	481.333
38	3.99579	1922.72	14.0303	Final Cover	100	16	110.013	230.108	453.74	0	453.74	481.231	481.231
39	3.99579	1922.26	14.0303	Final Cover	100	16	109.997	230.076	453.628	0	453.628	481.115	481.115
40	4.3757	2104.48	14.0308	Final Cover	100	16	109.981	230.041	453.508	0	453.508	480.992	480.992
41	4.3757	2103.91	14.0308	Final Cover	100	16	109.963	230.005	453.382	0	453.382	480.862	480.862
42	4.38295	2106.83	14.0308	Final Cover	100	16	109.946	229.969	453.256	0	453.256	480.731	480.731
43	4.38295	2106.25	14.0308	Final Cover	100	16	109.929	229.933	453.13	0	453.13	480.601	480.601
44	3.48577	1674.69	14.0314	Final Cover	100	16	109.913	229.899	453.012	0	453.012	480.48	480.48
45	3.48577	1674.31	14.0314	Final Cover	100	16	109.898	229.869	452.906	0	452.906	480.371	480.371
46	3.48078	1671.53	14.0314	Final Cover	100	16	109.884	229.839	452.801	0	452.801	480.262	480.262
47	3.48078	1671.15	14.0314	Final Cover	100	16	109.869	229.808	452.695	0	452.695	480.152	480.152
48	3.42125	1585.44	18.301	Final Cover	100	16	106.516	222.795	428.237	0	428.237	463.466	463.466
49	3.42125	1471.55	18.301	Final Cover	100	16	102.15	213.662	396.388	0	396.388	430.172	430.172
50	4.58589	1005.55	42.9459	Final Cover	100	16	69.0701	144.47	155.087	0	155.087	219.374	219.374

Query 1 (janbu simplified) - Safety Factor: 2.09165

Slice Number	Width [ft]	Weight [lbs]	Angle of Slice Base [deg]	Base Material	Base Cohesion [psf]	Base Friction Angle [deg]	Shear Stress [psf]	Shear Strength [psf]	Base Normal Stress [psf]	Pore Pressure [psf]	Effective Normal Stress [psf]	Base Vertical Stress [psf]	Effective Vertical Stress [psf]
1	4.2601	620.536	-17.7561	Final Cover	100	16	70.8849	148.266	168.325	0	168.325	145.626	145.626
2	4.40251	1483	4.41972	Final Cover	100	16	93.0046	194.533	329.676	0	329.676	336.865	336.865
3	4.40251	1883.88	4.41972	Final Cover	100	16	105.357	220.37	419.778	0	419.778	427.922	427.922
4	5.60493	2675.28	13.3951	Final Cover	100	16	109.669	229.389	451.232	0	451.232	477.349	477.349
5	4.27206	2056.2	13.989	Final Cover	100	16	110.04	230.166	453.942	0	453.942	481.356	481.356
6	5.38724	2594.49	13.9921	Final Cover	100	16	110.078	230.244	454.214	0	454.214	481.643	481.643
7	5.38724	2596.12	13.9921	Final Cover	100	16	110.118	230.328	454.507	0	454.507	481.947	481.947
8	5.18467	2499.91	13.9965	Final Cover	100	16	110.153	230.401	454.761	0	454.761	482.218	482.218
9	5.97866	2883.57	14.015	Final Cover	100	16	110.166	230.428	454.857	0	454.857	482.355	482.355
10	5.97866	2883.76	14.015	Final Cover	100	16	110.17	230.437	454.888	0	454.888	482.387	482.387
11	5.80911	2801.96	14.0204	Final Cover	100	16	110.168	230.433	454.874	0	454.874	482.384	482.384
12	4.50173	2171.21	14.0204	Final Cover	100	16	110.163	230.423	454.841	0	454.841	482.349	482.349
13	4.50173	2171.07	14.0204	Final Cover	100	16	110.159	230.415	454.81	0	454.81	482.318	482.318
14	4.50173	2170.93	14.0204	Final Cover	100	16	110.156	230.407	454.782	0	454.782	482.289	482.289
15	4.50173	2170.8	14.0204	Final Cover	100	16	110.151	230.398	454.752	0	454.752	482.258	482.258
16	3.25854	1571.23	14.0204	Final Cover	100	16	110.148	230.391	454.726	0	454.726	482.231	482.231
17	3.25854	1571.16	14.0204	Final Cover	100	16	110.145	230.385	454.706	0	454.706	482.209	482.209
18	3.25854	1571.09	14.0204	Final Cover	100	16	110.142	230.379	454.685	0	454.685	482.188	482.188
19	3.25854	1571.01	14.0204	Final Cover	100	16	110.139	230.373	454.664	0	454.664	482.166	482.166
20	3.25853	1570.94	14.0204	Final Cover	100	16	110.136	230.367	454.644	0	454.644	482.146	482.146
21	3.25853	1570.87	14.0204	Final Cover	100	16	110.134	230.361	454.623	0	454.623	482.124	482.124
22	3.25853	1570.8	14.0204	Final Cover	100	16	110.131	230.355	454.602	0	454.602	482.102	482.102
23	3.25853	1570.73	14.0204	Final Cover	100	16	110.128	230.349	454.578	0	454.578	482.078	482.078
24	5.20312	2507.94	14.0204	Final Cover	100	16	110.124	230.341	454.552	0	454.552	482.051	482.051
25	5.20312	2507.76	14.0204	Final Cover	100	16	110.119	230.331	454.519	0	454.519	482.016	482.016
26	5.26183	2535.87	14.0204	Final Cover	100	16	110.115	230.321	454.485	0	454.485	481.981	481.981
27	5.26183	2535.68	14.0204	Final Cover	100	16	110.11	230.311	454.45	0	454.45	481.945	481.945
28	5.266	2537.51	14.0204	Final Cover	100	16	110.105	230.302	454.416	0	454.416	481.91	481.91
29	5.266	2537.32	14.0204	Final Cover	100	16	110.101	230.292	454.383	0	454.383	481.875	481.875
30	3.3046	1592.16	14.0205	Final Cover	100	16	110.097	230.284	454.354	0	454.354	481.846	481.846
31	3.3046	1592.08	14.0205	Final Cover	100	16	110.093	230.277	454.331	0	454.331	481.822	481.822
32	3.67714	1771.37	14.0277	Final Cover	100	16	110.084	230.258	454.264	0	454.264	481.768	481.768
33	3.67714	1771.06	14.0277	Final Cover	100	16	110.073	230.235	454.183	0	454.183	481.684	481.684

Slide2-FC Section C_Total Stress

Permit Page - IILL-1878

34	3.08175	1484.03	14.0303	Final Cover	100	16	110.061	230.209	454.095	0	454.095	481.598	481.598
35	3.08175	1483.75	14.0303	Final Cover	100	16	110.049	230.185	454.007	0	454.007	481.507	481.507
36	3.06195	1473.95	14.0303	Final Cover	100	16	110.038	230.16	453.921	0	453.921	481.418	481.418
37	3.06195	1473.68	14.0303	Final Cover	100	16	110.026	230.136	453.839	0	453.839	481.333	481.333
38	3.99579	1922.72	14.0303	Final Cover	100	16	110.013	230.108	453.74	0	453.74	481.231	481.231
39	3.99579	1922.26	14.0303	Final Cover	100	16	109.997	230.076	453.628	0	453.628	481.115	481.115
40	4.3757	2104.48	14.0308	Final Cover	100	16	109.981	230.041	453.508	0	453.508	480.992	480.992
41	4.3757	2103.91	14.0308	Final Cover	100	16	109.963	230.005	453.382	0	453.382	480.862	480.862
42	4.38295	2106.83	14.0308	Final Cover	100	16	109.946	229.969	453.256	0	453.256	480.731	480.731
43	4.38295	2106.25	14.0308	Final Cover	100	16	109.929	229.933	453.13	0	453.13	480.601	480.601
44	3.48577	1674.69	14.0314	Final Cover	100	16	109.913	229.899	453.012	0	453.012	480.48	480.48
45	3.48577	1674.31	14.0314	Final Cover	100	16	109.898	229.869	452.906	0	452.906	480.371	480.371
46	3.48078	1671.53	14.0314	Final Cover	100	16	109.884	229.839	452.801	0	452.801	480.262	480.262
47	3.48078	1671.15	14.0314	Final Cover	100	16	109.869	229.808	452.695	0	452.695	480.152	480.152
48	3.42125	1585.44	18.301	Final Cover	100	16	106.516	222.795	428.237	0	428.237	463.466	463.466
49	3.42125	1471.55	18.301	Final Cover	100	16	102.15	213.662	396.388	0	396.388	430.172	430.172
50	4.58589	1005.55	42.9459	Final Cover	100	16	69.0701	144.47	155.087	0	155.087	219.374	219.374

Interslice Data

◆ Simplified Bishop Method - Total Stress

Global Minimum Query (bishop simplified) - Safety Factor: 2.47479

Slice Number	X coordinate [ft]	Y coordinate - Bottom [ft]	Interslice Normal Force [lbs]	Interslice Shear Force [lbs]	Interslice Force Angle [deg]
1	200.091	27.8836	0	0	0
2	202.194	28.115	85.026	0	0
3	204.298	28.3574	169.939	0	0
4	206.402	28.6109	254.002	0	0
5	208.506	28.8755	336.519	0	0
6	210.609	29.1513	416.838	0	0
7	212.713	29.4381	494.351	0	0
8	214.817	29.7361	568.491	0	0
9	216.921	30.0453	638.735	0	0
10	219.025	30.3658	704.603	0	0
11	221.128	30.6974	765.66	0	0
12	223.232	31.0404	821.512	0	0
13	225.336	31.3946	871.811	0	0
14	227.44	31.7601	916.251	0	0
15	229.543	32.137	954.572	0	0
16	231.647	32.5253	986.556	0	0
17	233.751	32.925	1012.03	0	0
18	235.855	33.3362	1030.88	0	0
19	237.958	33.7588	1043	0	0
20	240.062	34.193	1048.37	0	0
21	242.166	34.6388	1047.01	0	0
22	244.27	35.0961	1038.95	0	0
23	246.373	35.5651	1024.31	0	0
24	248.477	36.0458	1003.24	0	0
25	250.581	36.5382	975.935	0	0
26	252.685	37.0424	942.637	0	0
27	254.789	37.5584	903.644	0	0
28	256.892	38.0862	859.297	0	0
29	258.996	38.626	809.989	0	0
30	261.1	39.1777	756.164	0	0
31	263.204	39.7414	698.313	0	0
32	265.307	40.3172	636.983	0	0
33	267.411	40.9051	572.769	0	0
34	269.515	41.5052	506.32	0	0
35	271.619	42.1175	438.34	0	0
36	273.722	42.7421	369.586	0	0
37	275.826	43.379	300.868	0	0
38	277.93	44.0283	233.054	0	0
39	280.034	44.6901	167.068	0	0
40	282.138	45.3644	103.892	0	0
41	284.241	46.0513	44.5641	0	0
42	286.345	46.7509	-9.81537	0	0
43	288.449	47.4631	-58.0874	0	0
44	290.553	48.1882	-99.0315	0	0
45	292.656	48.9262	-131.364	0	0
46	294.76	49.6771	-153.739	0	0
47	296.864	50.441	-164.745	0	0
48	298.968	51.218	-162.904	0	0
49	301.071	52.0082	-146.671	0	0
50	303.175	52.8117	-113.743	0	0
51	305.279	53.6285	0	0	0

Query 1 (bishop simplified) - Safety Factor: 2.47479

Slice Number	X coordinate [ft]	Y coordinate - Bottom [ft]	Interslice Normal Force [lbs]	Interslice Shear Force [lbs]	Interslice Force Angle [deg]
1	200.091	27.8836	0	0	0
2	202.194	28.115	85.026	0	0
3	204.298	28.3574	169.939	0	0
4	206.402	28.6109	254.002	0	0
5	208.506	28.8755	336.519	0	0
6	210.609	29.1513	416.838	0	0
7	212.713	29.4381	494.351	0	0
8	214.817	29.7361	568.491	0	0
9	216.921	30.0453	638.735	0	0
10	219.025	30.3658	704.603	0	0
11	221.128	30.6974	765.66	0	0
12	223.232	31.0404	821.512	0	0
13	225.336	31.3946	871.811	0	0
14	227.44	31.7601	916.251	0	0
15	229.543	32.137	954.572	0	0
16	231.647	32.5253	986.556	0	0
17	233.751	32.925	1012.03	0	0
18	235.855	33.3362	1030.88	0	0
19	237.958	33.7588	1043	0	0
20	240.062	34.193	1048.37	0	0
21	242.166	34.6388	1047.01	0	0
22	244.27	35.0961	1038.95	0	0
23	246.373	35.5651	1024.31	0	0
24	248.477	36.0458	1003.24	0	0
25	250.581	36.5382	975.935	0	0
26	252.685	37.0424	942.637	0	0
27	254.789	37.5584	903.644	0	0
28	256.892	38.0862	859.297	0	0
29	258.996	38.626	809.989	0	0
30	261.1	39.1777	756.164	0	0
31	263.204	39.7414	698.313	0	0
32	265.307	40.3172	636.983	0	0
33	267.411	40.9051	572.769	0	0
34	269.515	41.5052	506.32	0	0
35	271.619	42.1175	438.34	0	0
36	273.722	42.7421	369.586	0	0
37	275.826	43.379	300.868	0	0
38	277.93	44.0283	233.054	0	0
39	280.034	44.6901	167.068	0	0
40	282.138	45.3644	103.892	0	0
41	284.241	46.0513	44.5641	0	0
42	286.345	46.7509	-9.81537	0	0
43	288.449	47.4631	-58.0874	0	0
44	290.553	48.1882	-99.0315	0	0
45	292.656	48.9262	-131.364	0	0
46	294.76	49.6771	-153.739	0	0
47	296.864	50.441	-164.745	0	0
48	298.968	51.218	-162.904	0	0
49	301.071	52.0082	-146.671	0	0
50	303.175	52.8117	-113.743	0	0
51	305.279	53.6285	0	0	0

◆ Simplified Janbu Method -Total Stress

Global Minimum Query (janbu simplified) - Safety Factor: 2.09165

Slice Number	X coordinate [ft]	Y coordinate - Bottom [ft]	Interslice Normal Force [lbs]	Interslice Shear Force [lbs]	Interslice Force Angle [deg]
1	94.9862	1.64424	0	0	0
2	99.2463	0.28007	531.117	0	0
3	103.649	0.620349	827.734	0	0
4	108.051	0.960628	1147.98	0	0
5	113.656	2.2954	1159.39	0	0
6	117.928	3.35967	1145.62	0	0
7	123.316	4.70207	1127.95	0	0
8	128.703	6.04447	1110.1	0	0
9	133.887	7.33681	1092.59	0	0
10	139.866	8.82912	1071.39	0	0
11	145.845	10.3214	1050.18	0	0
12	151.654	11.772	1029.31	0	0
13	156.156	12.8961	1013.15	0	0
14	160.657	14.0202	997.006	0	0
15	165.159	15.1443	980.878	0	0
16	169.661	16.2684	964.765	0	0
17	172.919	17.0821	953.111	0	0
18	176.178	17.8958	941.465	0	0
19	179.436	18.7095	929.827	0	0
20	182.695	19.5231	918.197	0	0
21	185.953	20.3368	906.574	0	0
22	189.212	21.1505	894.959	0	0
23	192.471	21.9642	883.352	0	0
24	195.729	22.7778	871.752	0	0
25	200.932	24.0771	853.247	0	0
26	206.135	25.3763	834.762	0	0
27	211.397	26.6902	816.088	0	0
28	216.659	28.0041	797.434	0	0
29	221.925	29.3191	778.786	0	0
30	227.191	30.6341	760.158	0	0
31	230.496	31.4592	748.476	0	0
32	233.8	32.2844	736.802	0	0
33	237.477	33.2031	723.617	0	0
34	241.154	34.1218	710.465	0	0
35	244.236	34.8919	699.407	0	0
36	247.318	35.662	688.378	0	0
37	250.38	36.4272	677.449	0	0
38	253.442	37.1923	666.55	0	0
39	257.438	38.1908	652.372	0	0
40	261.433	39.1893	638.243	0	0
41	265.809	40.2828	622.814	0	0
42	270.185	41.3763	607.447	0	0
43	274.568	42.4716	592.117	0	0
44	278.951	43.5669	576.85	0	0
45	282.436	44.438	564.736	0	0
46	285.922	45.3092	552.663	0	0
47	289.403	46.179	540.648	0	0
48	292.884	47.0489	528.676	0	0
49	296.305	48.1805	407.945	0	0
50	299.726	49.312	308.339	0	0
51	304.312	53.5803	0	0	0

Query 1 (janbu simplified) - Safety Factor: 2.09165

Slice Number	X coordinate [ft]	Y coordinate - Bottom [ft]	Interslice Normal Force [lbs]	Interslice Shear Force [lbs]	Interslice Force Angle [deg]
1	94.9862	1.64424	0	0	0
2	99.2463	0.28007	531.117	0	0
3	103.649	0.620349	827.734	0	0
4	108.051	0.960628	1147.98	0	0
5	113.656	2.2954	1159.39	0	0
6	117.928	3.35967	1145.62	0	0
7	123.316	4.70207	1127.95	0	0
8	128.703	6.04447	1110.1	0	0
9	133.887	7.33681	1092.59	0	0
10	139.866	8.82912	1071.39	0	0
11	145.845	10.3214	1050.18	0	0
12	151.654	11.772	1029.31	0	0
13	156.156	12.8961	1013.15	0	0
14	160.657	14.0202	997.006	0	0
15	165.159	15.1443	980.878	0	0
16	169.661	16.2684	964.765	0	0
17	172.919	17.0821	953.111	0	0
18	176.178	17.8958	941.465	0	0
19	179.436	18.7095	929.827	0	0
20	182.695	19.5231	918.197	0	0
21	185.953	20.3368	906.574	0	0
22	189.212	21.1505	894.959	0	0
23	192.471	21.9642	883.352	0	0
24	195.729	22.7778	871.752	0	0
25	200.932	24.0771	853.247	0	0
26	206.135	25.3763	834.762	0	0
27	211.397	26.6902	816.088	0	0
28	216.659	28.0041	797.434	0	0
29	221.925	29.3191	778.786	0	0
30	227.191	30.6341	760.158	0	0
31	230.496	31.4592	748.476	0	0
32	233.8	32.2844	736.802	0	0
33	237.477	33.2031	723.617	0	0
34	241.154	34.1218	710.465	0	0
35	244.236	34.8919	699.407	0	0
36	247.318	35.662	688.378	0	0
37	250.38	36.4272	677.449	0	0
38	253.442	37.1923	666.55	0	0
39	257.438	38.1908	652.372	0	0
40	261.433	39.1893	638.243	0	0
41	265.809	40.2828	622.814	0	0
42	270.185	41.3763	607.447	0	0
43	274.568	42.4716	592.117	0	0
44	278.951	43.5669	576.85	0	0
45	282.436	44.438	564.736	0	0
46	285.922	45.3092	552.663	0	0
47	289.403	46.179	540.648	0	0
48	292.884	47.0489	528.676	0	0
49	296.305	48.1805	407.945	0	0
50	299.726	49.312	308.339	0	0
51	304.312	53.5803	0	0	0

Discharge Sections

Entity Information

◆ Simplified Bishop Method - Total Stress

Shared Entities

Type	Coordinates (x,y)
External Boundary	0, 0 0, -11 0, -30.6081 0, -200 600, -200 600, -38.5 600, -34.5 600, 34.5 600, 63.5 600, 67.5 583.7, 67.5 302.7, 53.5 88.4, 0
Material Boundary	101, 0 134.147, -11 213.7, -37.4 600, -34.5
Material Boundary	88.4, 0 121.692, -11 181.037, -30.6081 213.7, -41.4 600, -38.5
Material Boundary	88.4, 0 101, 0 104.6, 0 302.7, 49.5 582.7, 63.5 600, 63.5
Material Boundary	0, -11 121.692, -11

◆ Simplified Janbu Method -Total Stress

Shared Entities

Type	Coordinates (x,y)
External Boundary	0, 0 0, -11 0, -30.6081 0, -200 600, -200 600, -38.5 600, -34.5 600, 34.5 600, 63.5 600, 67.5 583.7, 67.5 302.7, 53.5 88.4, 0
Material Boundary	101, 0 134.147, -11 213.7, -37.4 600, -34.5
Material Boundary	88.4, 0 121.692, -11 181.037, -30.6081 213.7, -41.4 600, -38.5
Material Boundary	88.4, 0 101, 0 104.6, 0 302.7, 49.5 582.7, 63.5 600, 63.5
Material Boundary	0, -11 121.692, -11

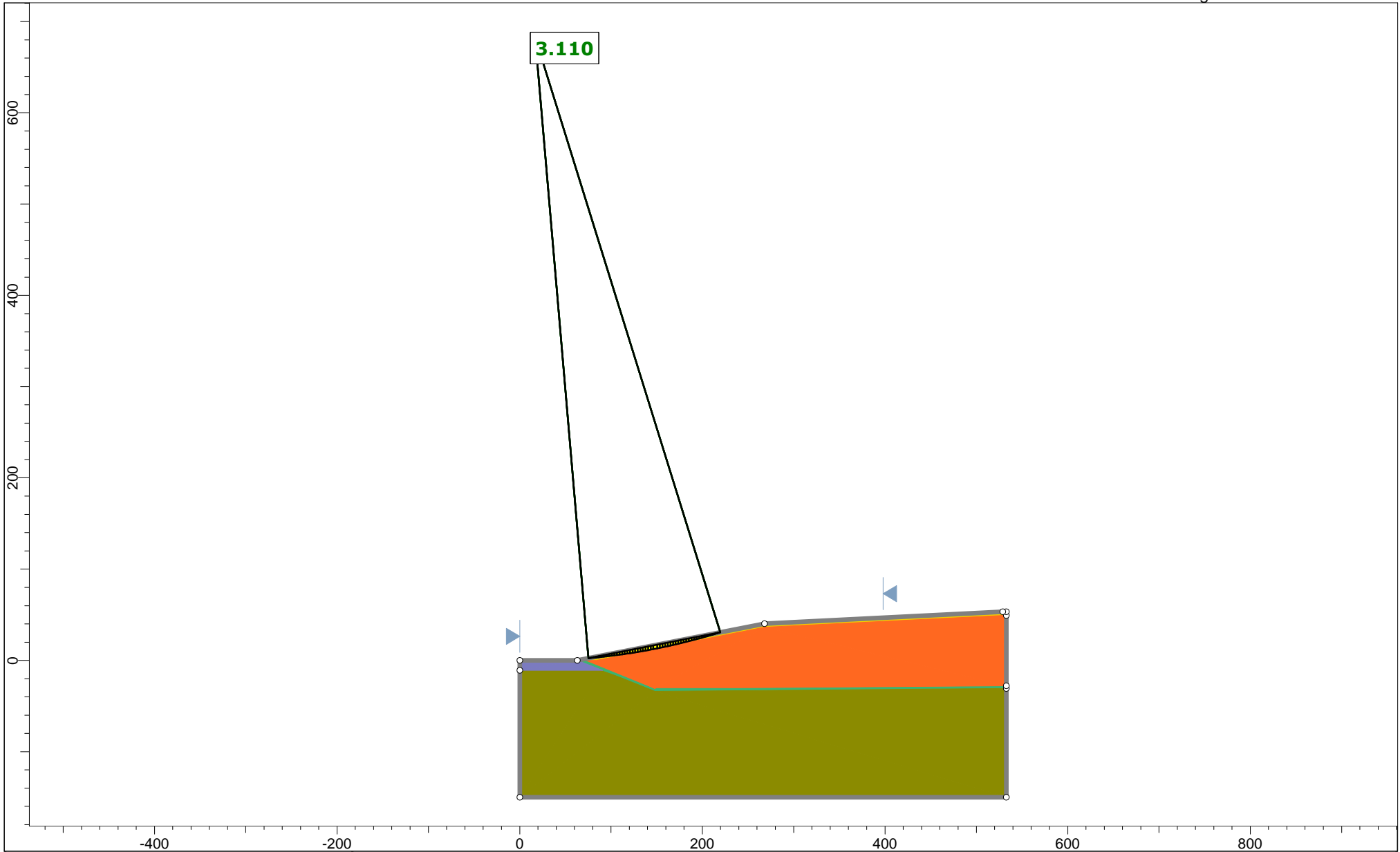

SLIDEINTERPRET 9.018

<i>Project</i>		SLIDE - An Interactive Slope Stability Program	
<i>Group</i>	Simplified Bishop Method - Effective Stress	<i>Scenario</i>	Master Scenario
<i>Drawn By</i>		<i>Company</i>	
<i>Date</i>		<i>File Name</i>	Slide2-FC Section D_Effective Stress.slmd

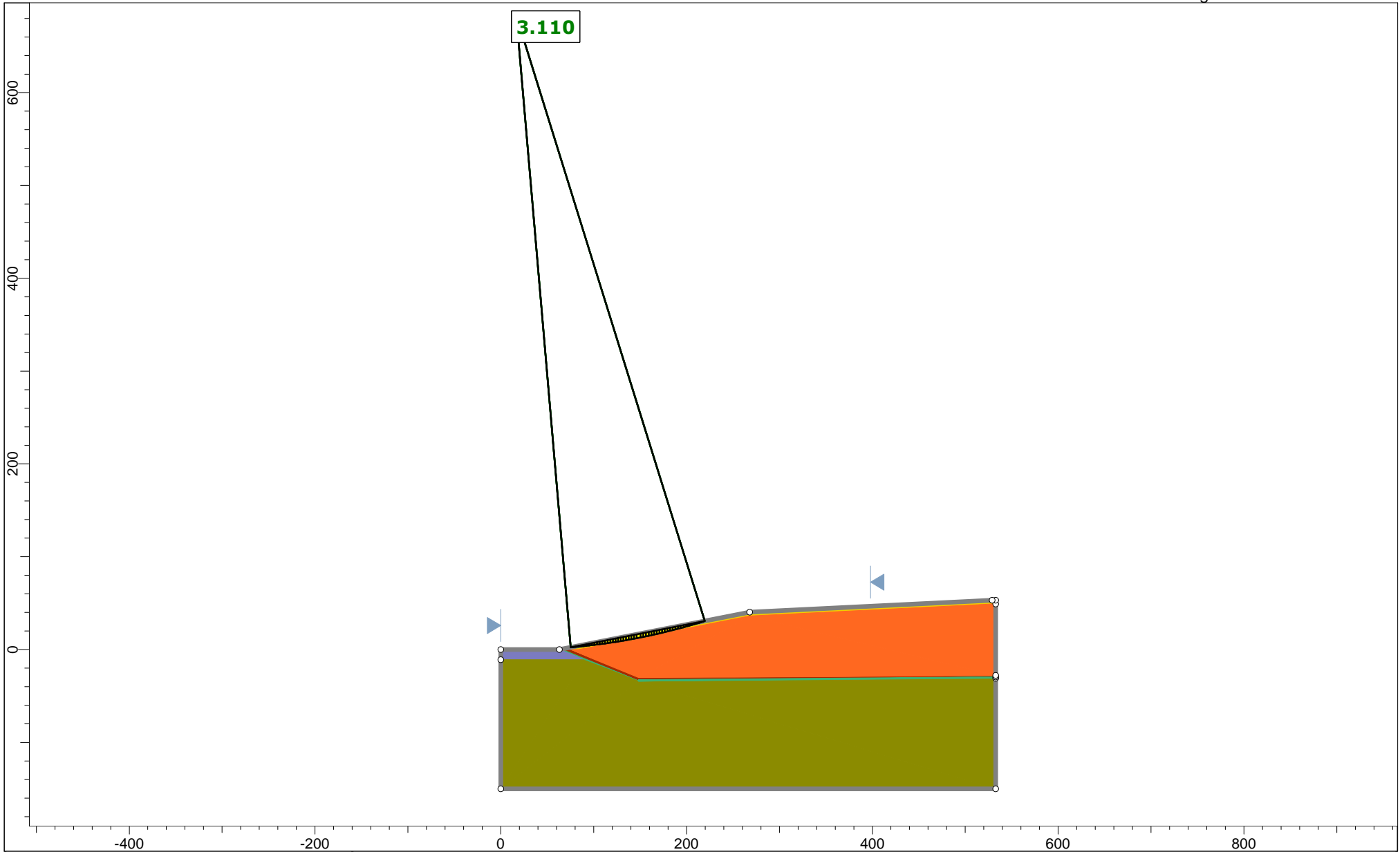

	<i>Project</i> SLIDE - An Interactive Slope Stability Program	
	<i>Group</i> Simplified Janbu Method - Effective Stress	<i>Scenario</i> Master Scenario
	<i>Drawn By</i>	<i>Company</i>
	<i>Date</i>	<i>File Name</i> Slide2-FC Section D_Effective Stress.slmd

Final Cover

Color	
Strength Type	Mohr-Coulomb
Unit Weight [lbs/ft3]	120
Cohesion [psf]	100
Friction Angle [deg]	16
Water Surface	Assigned per scenario
Ru Value	0

Liner

Color	
Strength Type	Mohr-Coulomb
Unit Weight [lbs/ft3]	120
Cohesion [psf]	100
Friction Angle [deg]	16
Water Surface	Assigned per scenario
Ru Value	0

Waste

Color	
Strength Type	Mohr-Coulomb
Unit Weight [lbs/ft3]	47
Cohesion [psf]	288
Friction Angle [deg]	23
Water Surface	Assigned per scenario
Ru Value	0

Stratum II

Color	
Strength Type	Mohr-Coulomb
Unit Weight [lbs/ft3]	110.9
Cohesion [psf]	206
Friction Angle [deg]	26
Water Surface	Assigned per scenario
Ru Value	0

Stratum III

Color	
Strength Type	Mohr-Coulomb
Unit Weight [lbs/ft3]	109
Cohesion [psf]	150
Friction Angle [deg]	24
Water Surface	Assigned per scenario
Ru Value	0

Protective Cover

Color	
Strength Type	Mohr-Coulomb
Unit Weight [lbs/ft3]	120
Cohesion [psf]	100
Friction Angle [deg]	16
Water Surface	Assigned per scenario
Ru Value	0

Materials In Use

Material		Simplified Bishop Method - Effective Stress	Simplified Janbu Method - Effective Stress
Final Cover		✓	✓
Liner		✓	✓
Waste		✓	✓
Stratum II		✓	✓
Stratum III		✓	✓
Protective Cover		✗	✓

Global Minimums

◆ Simplified Bishop Method - Effective Stress

Method: bishop simplified

FS	3.110460
Center:	16.676, 682.842
Radius:	682.974
Left Slip Surface Endpoint:	75.096, 2.372
Right Slip Surface Endpoint:	219.577, 30.704
Resisting Moment:	1.9096e+07 lb-ft
Driving Moment:	6.13928e+06 lb-ft
Total Slice Area:	390.64 ft ²
Surface Horizontal Width:	144.482 ft
Surface Average Height:	2.70373 ft

◆ Simplified Janbu Method - Effective Stress

Method: bishop simplified

FS	3.110460
Center:	16.676, 682.842
Radius:	682.974
Left Slip Surface Endpoint:	75.096, 2.372
Right Slip Surface Endpoint:	219.577, 30.704
Resisting Moment:	1.9096e+07 lb-ft
Driving Moment:	6.13928e+06 lb-ft
Total Slice Area:	390.64 ft ²
Surface Horizontal Width:	144.482 ft
Surface Average Height:	2.70373 ft

Valid and Invalid Surfaces

◆ Simplified Bishop Method - Effective Stress

Method: bishop simplified

Number of Valid Surfaces:	10946
Number of Invalid Surfaces:	0

◆ Simplified Janbu Method - Effective Stress

Method: bishop simplified

Number of Valid Surfaces:	10946
Number of Invalid Surfaces:	0

Slice Data

◆ Simplified Bishop Method - Effective Stress

Global Minimum Query (bishop simplified) - Safety Factor: 3.11046

Slice Number	Width [ft]	Weight [lbs]	Angle of Slice Base [deg]	Base Material	Base Cohesion [psf]	Base Friction Angle [deg]	Shear Stress [psf]	Shear Strength [psf]	Base Normal Stress [psf]	Pore Pressure [psf]	Effective Normal Stress [psf]	Base Vertical Stress [psf]	Effective Vertical Stress [psf]
1	2.84463	52.5032	5.02672	Final Cover	100	16	33.5792	104.447	15.5074	0	15.5074	18.461	18.461
2	2.84463	155.463	5.26632	Final Cover	100	16	36.8748	114.698	51.2569	0	51.2569	54.6558	54.6558
3	2.84463	254.326	5.50602	Final Cover	100	16	40.0364	124.531	85.5517	0	85.5517	89.411	89.411
4	2.84463	349.088	5.74582	Final Cover	100	16	43.0638	133.948	118.391	0	118.391	122.724	122.724
5	2.84463	439.745	5.98572	Final Cover	100	16	45.957	142.947	149.776	0	149.776	154.594	154.594
6	2.84463	526.29	6.22572	Final Cover	100	16	48.7161	151.529	179.705	0	179.705	185.019	185.019
7	2.84463	608.718	6.46583	Final Cover	100	16	51.341	159.694	208.178	0	208.178	213.996	213.996
8	2.84463	687.023	6.70606	Final Cover	100	16	53.8316	167.441	235.195	0	235.195	241.525	241.525
9	2.84463	761.2	6.9464	Final Cover	100	16	56.188	174.77	260.756	0	260.756	267.602	267.602
10	2.84463	831.242	7.18687	Final Cover	100	16	58.41	181.682	284.859	0	284.859	292.225	292.225
11	2.84463	897.143	7.42747	Final Cover	100	16	60.4977	188.176	307.505	0	307.505	315.392	315.392
12	2.84463	958.896	7.6682	Final Cover	100	16	62.451	194.251	328.693	0	328.693	337.101	337.101
13	2.84463	1016.49	7.90906	Final Cover	100	16	64.2697	199.908	348.422	0	348.422	357.35	357.35
14	2.84463	1069.93	8.15006	Final Cover	100	16	65.9539	205.147	366.69	0	366.69	376.135	376.135
15	2.84463	1119.2	8.39121	Final Cover	100	16	67.5032	209.966	383.496	0	383.496	393.454	393.454
16	2.84463	1164.28	8.63251	Final Cover	100	16	68.9181	214.367	398.843	0	398.843	409.305	409.305
17	2.84463	1205.19	8.87397	Final Cover	100	16	70.1977	218.347	412.727	0	412.727	423.687	423.687
18	2.84463	1241.9	9.11558	Final Cover	100	16	71.3425	221.908	425.145	0	425.145	436.592	436.592
19	2.84463	1274.41	9.35735	Final Cover	100	16	72.3523	225.049	436.099	0	436.099	448.021	448.021
20	2.84463	1302.71	9.5993	Final Cover	100	16	73.2271	227.77	445.587	0	445.587	457.971	457.971
21	2.84463	1326.79	9.84142	Final Cover	100	16	73.9662	230.069	453.605	0	453.605	466.436	466.436
22	2.84463	1346.64	10.0837	Final Cover	100	16	74.57	231.947	460.152	0	460.152	473.413	473.413
23	2.84463	1362.25	10.3262	Final Cover	100	16	75.0381	233.403	465.232	0	465.232	478.904	478.904
24	2.84463	1373.62	10.5689	Final Cover	100	16	75.3705	234.437	468.836	0	468.836	482.898	482.898
25	2.84463	1380.73	10.8117	Final Cover	100	16	75.567	235.048	470.968	0	470.968	485.399	485.399
26	4.33239	2106.16	11.1184	Final Cover	100	16	75.5981	235.145	471.306	0	471.306	486.163	486.163
27	2.87639	1395.03	11.4267	Final Cover	100	16	75.4557	234.702	469.761	0	469.761	485.012	485.012
28	2.87639	1386.83	11.673	Final Cover	100	16	75.1673	233.805	466.631	0	466.631	482.161	482.161
29	2.87639	1374.17	11.9195	Final Cover	100	16	74.7391	232.473	461.987	0	461.987	477.764	477.764

Slide2-FC Section D_Effective Stress

Permit Page - IILL-1892

30	2.87639	1357.05	12.1662	Final Cover	100	16	74.1707	230.705	455.823	0	455.823	471.814	471.814
31	2.87639	1335.46	12.4132	Final Cover	100	16	73.4621	228.501	448.136	0	448.136	464.306	464.306
32	2.87639	1309.37	12.6604	Final Cover	100	16	72.6131	225.86	438.924	0	438.924	455.236	455.236
33	2.87639	1278.79	12.9078	Final Cover	100	16	71.6232	222.781	428.189	0	428.189	444.604	444.604
34	2.87639	1243.69	13.1555	Final Cover	100	16	70.4925	219.264	415.923	0	415.923	432.399	432.399
35	2.87639	1204.06	13.4035	Final Cover	100	16	69.2206	215.308	402.13	0	402.13	418.625	418.625
36	2.87639	1159.89	13.6516	Final Cover	100	16	67.8073	210.912	386.799	0	386.799	403.268	403.268
37	2.87639	1111.16	13.9001	Final Cover	100	16	66.2523	206.075	369.929	0	369.929	386.325	386.325
38	2.87639	1057.86	14.1488	Final Cover	100	16	64.5554	200.797	351.519	0	351.519	367.793	367.793
39	2.87639	999.97	14.3978	Final Cover	100	16	62.7161	195.076	331.569	0	331.569	347.669	347.669
40	2.87639	937.482	14.6471	Final Cover	100	16	60.7343	188.911	310.071	0	310.071	325.945	325.945
41	2.87639	870.377	14.8966	Final Cover	100	16	58.6095	182.303	287.023	0	287.023	302.615	302.615
42	2.87639	798.638	15.1465	Final Cover	100	16	56.3416	175.248	262.422	0	262.422	277.673	277.673
43	2.87639	722.25	15.3966	Final Cover	100	16	53.9302	167.748	236.265	0	236.265	251.116	251.116
44	2.87639	641.196	15.6471	Final Cover	100	16	51.375	159.8	208.547	0	208.547	222.937	222.937
45	2.87639	555.459	15.8978	Final Cover	100	16	48.6756	151.404	179.265	0	179.265	193.129	193.129
46	2.87639	465.022	16.1489	Final Cover	100	16	45.8316	142.558	148.416	0	148.416	161.687	161.687
47	2.87639	369.866	16.4002	Final Cover	100	16	42.8428	133.261	115.995	0	115.995	128.604	128.604
48	2.87639	269.974	16.6519	Final Cover	100	16	39.7088	123.513	81.9979	0	81.9979	93.8748	93.8748
49	2.87639	165.327	16.904	Final Cover	100	16	36.4291	113.311	46.4218	0	46.4218	57.4925	57.4925
50	2.87639	55.9063	17.1564	Final Cover	100	16	33.0034	102.656	9.26151	0	9.26151	19.4502	19.4502

Query 1 (bishop simplified) - Safety Factor: 3.11046

Slice Number	Width [ft]	Weight [lbs]	Angle of Slice Base [deg]	Base Material	Base Cohesion [psf]	Base Friction Angle [deg]	Shear Stress [psf]	Shear Strength [psf]	Base Normal Stress [psf]	Pore Pressure [psf]	Effective Normal Stress [psf]	Base Vertical Stress [psf]	Effective Vertical Stress [psf]
1	2.84463	52.5032	5.02672	Final Cover	100	16	33.5792	104.447	15.5074	0	15.5074	18.461	18.461
2	2.84463	155.463	5.26632	Final Cover	100	16	36.8748	114.698	51.2569	0	51.2569	54.6558	54.6558
3	2.84463	254.326	5.50602	Final Cover	100	16	40.0364	124.531	85.5517	0	85.5517	89.411	89.411
4	2.84463	349.088	5.74582	Final Cover	100	16	43.0638	133.948	118.391	0	118.391	122.724	122.724
5	2.84463	439.745	5.98572	Final Cover	100	16	45.957	142.947	149.776	0	149.776	154.594	154.594
6	2.84463	526.29	6.22572	Final Cover	100	16	48.7161	151.529	179.705	0	179.705	185.019	185.019
7	2.84463	608.718	6.46583	Final Cover	100	16	51.341	159.694	208.178	0	208.178	213.996	213.996
8	2.84463	687.023	6.70606	Final Cover	100	16	53.8316	167.441	235.195	0	235.195	241.525	241.525
9	2.84463	761.2	6.9464	Final Cover	100	16	56.188	174.77	260.756	0	260.756	267.602	267.602
10	2.84463	831.242	7.18687	Final Cover	100	16	58.41	181.682	284.859	0	284.859	292.225	292.225
11	2.84463	897.143	7.42747	Final Cover	100	16	60.4977	188.176	307.505	0	307.505	315.392	315.392
12	2.84463	958.896	7.6682	Final Cover	100	16	62.451	194.251	328.693	0	328.693	337.101	337.101
13	2.84463	1016.49	7.90906	Final Cover	100	16	64.2697	199.908	348.422	0	348.422	357.35	357.35
14	2.84463	1069.93	8.15006	Final Cover	100	16	65.9539	205.147	366.69	0	366.69	376.135	376.135
15	2.84463	1119.2	8.39121	Final Cover	100	16	67.5032	209.966	383.496	0	383.496	393.454	393.454
16	2.84463	1164.28	8.63251	Final Cover	100	16	68.9181	214.367	398.843	0	398.843	409.305	409.305
17	2.84463	1205.19	8.87397	Final Cover	100	16	70.1977	218.347	412.727	0	412.727	423.687	423.687
18	2.84463	1241.9	9.11558	Final Cover	100	16	71.3425	221.908	425.145	0	425.145	436.592	436.592
19	2.84463	1274.41	9.35735	Final Cover	100	16	72.3523	225.049	436.099	0	436.099	448.021	448.021
20	2.84463	1302.71	9.5993	Final Cover	100	16	73.2271	227.77	445.587	0	445.587	457.971	457.971
21	2.84463	1326.79	9.84142	Final Cover	100	16	73.9662	230.069	453.605	0	453.605	466.436	466.436
22	2.84463	1346.64	10.0837	Final Cover	100	16	74.57	231.947	460.152	0	460.152	473.413	473.413
23	2.84463	1362.25	10.3262	Final Cover	100	16	75.0381	233.403	465.232	0	465.232	478.904	478.904
24	2.84463	1373.62	10.5689	Final Cover	100	16	75.3705	234.437	468.836	0	468.836	482.898	482.898
25	2.84463	1380.73	10.8117	Final Cover	100	16	75.567	235.048	470.968	0	470.968	485.399	485.399
26	4.33239	2106.16	11.1184	Final Cover	100	16	75.5981	235.145	471.306	0	471.306	486.163	486.163
27	2.87639	1395.03	11.4267	Final Cover	100	16	75.4557	234.702	469.761	0	469.761	485.012	485.012
28	2.87639	1386.83	11.673	Final Cover	100	16	75.1673	233.805	466.631	0	466.631	482.161	482.161
29	2.87639	1374.17	11.9195	Final Cover	100	16	74.7391	232.473	461.987	0	461.987	477.764	477.764
30	2.87639	1357.05	12.1662	Final Cover	100	16	74.1707	230.705	455.823	0	455.823	471.814	471.814
31	2.87639	1335.46	12.4132	Final Cover	100	16	73.4621	228.501	448.136	0	448.136	464.306	464.306
32	2.87639	1309.37	12.6604	Final Cover	100	16	72.6131	225.86	438.924	0	438.924	455.236	455.236
33	2.87639	1278.79	12.9078	Final Cover	100	16	71.6232	222.781	428.189	0	428.189	444.604	444.604

34	2.87639	1243.69	13.1555	Final Cover	100	16	70.4925	219.264	415.923	0	415.923	432.399	432.399
35	2.87639	1204.06	13.4035	Final Cover	100	16	69.2206	215.308	402.13	0	402.13	418.625	418.625
36	2.87639	1159.89	13.6516	Final Cover	100	16	67.8073	210.912	386.799	0	386.799	403.268	403.268
37	2.87639	1111.16	13.9001	Final Cover	100	16	66.2523	206.075	369.929	0	369.929	386.325	386.325
38	2.87639	1057.86	14.1488	Final Cover	100	16	64.5554	200.797	351.519	0	351.519	367.793	367.793
39	2.87639	999.97	14.3978	Final Cover	100	16	62.7161	195.076	331.569	0	331.569	347.669	347.669
40	2.87639	937.482	14.6471	Final Cover	100	16	60.7343	188.911	310.071	0	310.071	325.945	325.945
41	2.87639	870.377	14.8966	Final Cover	100	16	58.6095	182.303	287.023	0	287.023	302.615	302.615
42	2.87639	798.638	15.1465	Final Cover	100	16	56.3416	175.248	262.422	0	262.422	277.673	277.673
43	2.87639	722.25	15.3966	Final Cover	100	16	53.9302	167.748	236.265	0	236.265	251.116	251.116
44	2.87639	641.196	15.6471	Final Cover	100	16	51.375	159.8	208.547	0	208.547	222.937	222.937
45	2.87639	555.459	15.8978	Final Cover	100	16	48.6756	151.404	179.265	0	179.265	193.129	193.129
46	2.87639	465.022	16.1489	Final Cover	100	16	45.8316	142.558	148.416	0	148.416	161.687	161.687
47	2.87639	369.866	16.4002	Final Cover	100	16	42.8428	133.261	115.995	0	115.995	128.604	128.604
48	2.87639	269.974	16.6519	Final Cover	100	16	39.7088	123.513	81.9979	0	81.9979	93.8748	93.8748
49	2.87639	165.327	16.904	Final Cover	100	16	36.4291	113.311	46.4218	0	46.4218	57.4925	57.4925
50	2.87639	55.9063	17.1564	Final Cover	100	16	33.0034	102.656	9.26151	0	9.26151	19.4502	19.4502

◆ Simplified Janbu Method - Effective Stress

Global Minimum Query (bishop simplified) - Safety Factor: 3.11046

Slice Number	Width [ft]	Weight [lbs]	Angle of Slice Base [deg]	Base Material	Base Cohesion [psf]	Base Friction Angle [deg]	Shear Stress [psf]	Shear Strength [psf]	Base Normal Stress [psf]	Pore Pressure [psf]	Effective Normal Stress [psf]	Base Vertical Stress [psf]	Effective Vertical Stress [psf]
1	2.84463	52.5032	5.02672	Final Cover	100	16	33.5792	104.447	15.5074	0	15.5074	18.461	18.461
2	2.84463	155.463	5.26632	Final Cover	100	16	36.8748	114.698	51.2569	0	51.2569	54.6558	54.6558
3	2.84463	254.326	5.50602	Final Cover	100	16	40.0364	124.531	85.5517	0	85.5517	89.411	89.411
4	2.84463	349.088	5.74582	Final Cover	100	16	43.0638	133.948	118.391	0	118.391	122.724	122.724
5	2.84463	439.745	5.98572	Final Cover	100	16	45.957	142.947	149.776	0	149.776	154.594	154.594
6	2.84463	526.29	6.22572	Final Cover	100	16	48.7161	151.529	179.705	0	179.705	185.019	185.019
7	2.84463	608.718	6.46583	Final Cover	100	16	51.341	159.694	208.178	0	208.178	213.996	213.996
8	2.84463	687.023	6.70606	Final Cover	100	16	53.8316	167.441	235.195	0	235.195	241.525	241.525
9	2.84463	761.2	6.9464	Final Cover	100	16	56.188	174.77	260.756	0	260.756	267.602	267.602
10	2.84463	831.242	7.18687	Final Cover	100	16	58.41	181.682	284.859	0	284.859	292.225	292.225
11	2.84463	897.143	7.42747	Final Cover	100	16	60.4977	188.176	307.505	0	307.505	315.392	315.392
12	2.84463	958.896	7.6682	Final Cover	100	16	62.451	194.251	328.693	0	328.693	337.101	337.101
13	2.84463	1016.49	7.90906	Final Cover	100	16	64.2697	199.908	348.422	0	348.422	357.35	357.35
14	2.84463	1069.93	8.15006	Final Cover	100	16	65.9539	205.147	366.69	0	366.69	376.135	376.135
15	2.84463	1119.2	8.39121	Final Cover	100	16	67.5032	209.966	383.496	0	383.496	393.454	393.454
16	2.84463	1164.28	8.63251	Final Cover	100	16	68.9181	214.367	398.843	0	398.843	409.305	409.305
17	2.84463	1205.19	8.87397	Final Cover	100	16	70.1977	218.347	412.727	0	412.727	423.687	423.687
18	2.84463	1241.9	9.11558	Final Cover	100	16	71.3425	221.908	425.145	0	425.145	436.592	436.592
19	2.84463	1274.41	9.35735	Final Cover	100	16	72.3523	225.049	436.099	0	436.099	448.021	448.021
20	2.84463	1302.71	9.5993	Final Cover	100	16	73.2271	227.77	445.587	0	445.587	457.971	457.971
21	2.84463	1326.79	9.84142	Final Cover	100	16	73.9662	230.069	453.605	0	453.605	466.436	466.436
22	2.84463	1346.64	10.0837	Final Cover	100	16	74.57	231.947	460.152	0	460.152	473.413	473.413
23	2.84463	1362.25	10.3262	Final Cover	100	16	75.0381	233.403	465.232	0	465.232	478.904	478.904
24	2.84463	1373.62	10.5689	Final Cover	100	16	75.3705	234.437	468.836	0	468.836	482.898	482.898
25	2.84463	1380.73	10.8117	Final Cover	100	16	75.567	235.048	470.968	0	470.968	485.399	485.399
26	4.33239	2106.16	11.1184	Final Cover	100	16	75.5981	235.145	471.306	0	471.306	486.163	486.163
27	2.87639	1395.03	11.4267	Final Cover	100	16	75.4557	234.702	469.761	0	469.761	485.012	485.012
28	2.87639	1386.83	11.673	Final Cover	100	16	75.1673	233.805	466.631	0	466.631	482.161	482.161
29	2.87639	1374.17	11.9195	Final Cover	100	16	74.7391	232.473	461.987	0	461.987	477.764	477.764
30	2.87639	1357.05	12.1662	Final Cover	100	16	74.1707	230.705	455.823	0	455.823	471.814	471.814
31	2.87639	1335.46	12.4132	Final Cover	100	16	73.4621	228.501	448.136	0	448.136	464.306	464.306
32	2.87639	1309.37	12.6604	Final Cover	100	16	72.6131	225.86	438.924	0	438.924	455.236	455.236

Slide2-FC Section D_Effective Stress

Permit Page - IILL-1896

33	2.87639	1278.79	12.9078	Final Cover	100	16	71.6232	222.781	428.189	0	428.189	444.604	444.604
34	2.87639	1243.69	13.1555	Final Cover	100	16	70.4925	219.264	415.923	0	415.923	432.399	432.399
35	2.87639	1204.06	13.4035	Final Cover	100	16	69.2206	215.308	402.13	0	402.13	418.625	418.625
36	2.87639	1159.89	13.6516	Final Cover	100	16	67.8073	210.912	386.799	0	386.799	403.268	403.268
37	2.87639	1111.16	13.9001	Final Cover	100	16	66.2523	206.075	369.929	0	369.929	386.325	386.325
38	2.87639	1057.86	14.1488	Final Cover	100	16	64.5554	200.797	351.519	0	351.519	367.793	367.793
39	2.87639	999.97	14.3978	Final Cover	100	16	62.7161	195.076	331.569	0	331.569	347.669	347.669
40	2.87639	937.482	14.6471	Final Cover	100	16	60.7343	188.911	310.071	0	310.071	325.945	325.945
41	2.87639	870.377	14.8966	Final Cover	100	16	58.6095	182.303	287.023	0	287.023	302.615	302.615
42	2.87639	798.638	15.1465	Final Cover	100	16	56.3416	175.248	262.422	0	262.422	277.673	277.673
43	2.87639	722.25	15.3966	Final Cover	100	16	53.9302	167.748	236.265	0	236.265	251.116	251.116
44	2.87639	641.196	15.6471	Final Cover	100	16	51.375	159.8	208.547	0	208.547	222.937	222.937
45	2.87639	555.459	15.8978	Final Cover	100	16	48.6756	151.404	179.265	0	179.265	193.129	193.129
46	2.87639	465.022	16.1489	Final Cover	100	16	45.8316	142.558	148.416	0	148.416	161.687	161.687
47	2.87639	369.866	16.4002	Final Cover	100	16	42.8428	133.261	115.995	0	115.995	128.604	128.604
48	2.87639	269.974	16.6519	Final Cover	100	16	39.7088	123.513	81.9979	0	81.9979	93.8748	93.8748
49	2.87639	165.327	16.904	Final Cover	100	16	36.4291	113.311	46.4218	0	46.4218	57.4925	57.4925
50	2.87639	55.9063	17.1564	Final Cover	100	16	33.0034	102.656	9.26151	0	9.26151	19.4502	19.4502

Query 1 (bishop simplified) - Safety Factor: 3.11046

Slice Number	Width [ft]	Weight [lbs]	Angle of Slice Base [deg]	Base Material	Base Cohesion [psf]	Base Friction Angle [deg]	Shear Stress [psf]	Shear Strength [psf]	Base Normal Stress [psf]	Pore Pressure [psf]	Effective Normal Stress [psf]	Base Vertical Stress [psf]	Effective Vertical Stress [psf]
1	2.84463	52.5032	5.02672	Final Cover	100	16	33.5792	104.447	15.5074	0	15.5074	18.461	18.461
2	2.84463	155.463	5.26632	Final Cover	100	16	36.8748	114.698	51.2569	0	51.2569	54.6558	54.6558
3	2.84463	254.326	5.50602	Final Cover	100	16	40.0364	124.531	85.5517	0	85.5517	89.411	89.411
4	2.84463	349.088	5.74582	Final Cover	100	16	43.0638	133.948	118.391	0	118.391	122.724	122.724
5	2.84463	439.745	5.98572	Final Cover	100	16	45.957	142.947	149.776	0	149.776	154.594	154.594
6	2.84463	526.29	6.22572	Final Cover	100	16	48.7161	151.529	179.705	0	179.705	185.019	185.019
7	2.84463	608.718	6.46583	Final Cover	100	16	51.341	159.694	208.178	0	208.178	213.996	213.996
8	2.84463	687.023	6.70606	Final Cover	100	16	53.8316	167.441	235.195	0	235.195	241.525	241.525
9	2.84463	761.2	6.9464	Final Cover	100	16	56.188	174.77	260.756	0	260.756	267.602	267.602
10	2.84463	831.242	7.18687	Final Cover	100	16	58.41	181.682	284.859	0	284.859	292.225	292.225
11	2.84463	897.143	7.42747	Final Cover	100	16	60.4977	188.176	307.505	0	307.505	315.392	315.392
12	2.84463	958.896	7.6682	Final Cover	100	16	62.451	194.251	328.693	0	328.693	337.101	337.101
13	2.84463	1016.49	7.90906	Final Cover	100	16	64.2697	199.908	348.422	0	348.422	357.35	357.35
14	2.84463	1069.93	8.15006	Final Cover	100	16	65.9539	205.147	366.69	0	366.69	376.135	376.135
15	2.84463	1119.2	8.39121	Final Cover	100	16	67.5032	209.966	383.496	0	383.496	393.454	393.454
16	2.84463	1164.28	8.63251	Final Cover	100	16	68.9181	214.367	398.843	0	398.843	409.305	409.305
17	2.84463	1205.19	8.87397	Final Cover	100	16	70.1977	218.347	412.727	0	412.727	423.687	423.687
18	2.84463	1241.9	9.11558	Final Cover	100	16	71.3425	221.908	425.145	0	425.145	436.592	436.592
19	2.84463	1274.41	9.35735	Final Cover	100	16	72.3523	225.049	436.099	0	436.099	448.021	448.021
20	2.84463	1302.71	9.5993	Final Cover	100	16	73.2271	227.77	445.587	0	445.587	457.971	457.971
21	2.84463	1326.79	9.84142	Final Cover	100	16	73.9662	230.069	453.605	0	453.605	466.436	466.436
22	2.84463	1346.64	10.0837	Final Cover	100	16	74.57	231.947	460.152	0	460.152	473.413	473.413
23	2.84463	1362.25	10.3262	Final Cover	100	16	75.0381	233.403	465.232	0	465.232	478.904	478.904
24	2.84463	1373.62	10.5689	Final Cover	100	16	75.3705	234.437	468.836	0	468.836	482.898	482.898
25	2.84463	1380.73	10.8117	Final Cover	100	16	75.567	235.048	470.968	0	470.968	485.399	485.399
26	4.33239	2106.16	11.1184	Final Cover	100	16	75.5981	235.145	471.306	0	471.306	486.163	486.163
27	2.87639	1395.03	11.4267	Final Cover	100	16	75.4557	234.702	469.761	0	469.761	485.012	485.012
28	2.87639	1386.83	11.673	Final Cover	100	16	75.1673	233.805	466.631	0	466.631	482.161	482.161
29	2.87639	1374.17	11.9195	Final Cover	100	16	74.7391	232.473	461.987	0	461.987	477.764	477.764
30	2.87639	1357.05	12.1662	Final Cover	100	16	74.1707	230.705	455.823	0	455.823	471.814	471.814
31	2.87639	1335.46	12.4132	Final Cover	100	16	73.4621	228.501	448.136	0	448.136	464.306	464.306
32	2.87639	1309.37	12.6604	Final Cover	100	16	72.6131	225.86	438.924	0	438.924	455.236	455.236
33	2.87639	1278.79	12.9078	Final Cover	100	16	71.6232	222.781	428.189	0	428.189	444.604	444.604

34	2.87639	1243.69	13.1555	Final Cover	100	16	70.4925	219.264	415.923	0	415.923	432.399	432.399
35	2.87639	1204.06	13.4035	Final Cover	100	16	69.2206	215.308	402.13	0	402.13	418.625	418.625
36	2.87639	1159.89	13.6516	Final Cover	100	16	67.8073	210.912	386.799	0	386.799	403.268	403.268
37	2.87639	1111.16	13.9001	Final Cover	100	16	66.2523	206.075	369.929	0	369.929	386.325	386.325
38	2.87639	1057.86	14.1488	Final Cover	100	16	64.5554	200.797	351.519	0	351.519	367.793	367.793
39	2.87639	999.97	14.3978	Final Cover	100	16	62.7161	195.076	331.569	0	331.569	347.669	347.669
40	2.87639	937.482	14.6471	Final Cover	100	16	60.7343	188.911	310.071	0	310.071	325.945	325.945
41	2.87639	870.377	14.8966	Final Cover	100	16	58.6095	182.303	287.023	0	287.023	302.615	302.615
42	2.87639	798.638	15.1465	Final Cover	100	16	56.3416	175.248	262.422	0	262.422	277.673	277.673
43	2.87639	722.25	15.3966	Final Cover	100	16	53.9302	167.748	236.265	0	236.265	251.116	251.116
44	2.87639	641.196	15.6471	Final Cover	100	16	51.375	159.8	208.547	0	208.547	222.937	222.937
45	2.87639	555.459	15.8978	Final Cover	100	16	48.6756	151.404	179.265	0	179.265	193.129	193.129
46	2.87639	465.022	16.1489	Final Cover	100	16	45.8316	142.558	148.416	0	148.416	161.687	161.687
47	2.87639	369.866	16.4002	Final Cover	100	16	42.8428	133.261	115.995	0	115.995	128.604	128.604
48	2.87639	269.974	16.6519	Final Cover	100	16	39.7088	123.513	81.9979	0	81.9979	93.8748	93.8748
49	2.87639	165.327	16.904	Final Cover	100	16	36.4291	113.311	46.4218	0	46.4218	57.4925	57.4925
50	2.87639	55.9063	17.1564	Final Cover	100	16	33.0034	102.656	9.26151	0	9.26151	19.4502	19.4502

Interslice Data

◆ Simplified Bishop Method - Effective Stress

Global Minimum Query (bishop simplified) - Safety Factor: 3.11046

Slice Number	X coordinate [ft]	Y coordinate - Bottom [ft]	Interslice Normal Force [lbs]	Interslice Shear Force [lbs]	Interslice Force Angle [deg]
1	75.0955	2.3719	0	0	0
2	77.9402	2.62211	91.5096	0	0
3	80.7848	2.88431	182.822	0	0
4	83.6294	3.15852	273.096	0	0
5	86.474	3.44475	361.541	0	0
6	89.3187	3.74302	447.42	0	0
7	92.1633	4.05334	530.045	0	0
8	95.0079	4.37572	608.777	0	0
9	97.8526	4.7102	683.033	0	0
10	100.697	5.05677	752.276	0	0
11	103.542	5.41547	816.026	0	0
12	106.386	5.78631	873.849	0	0
13	109.231	6.16931	925.366	0	0
14	112.076	6.56449	970.249	0	0
15	114.92	6.97188	1008.22	0	0
16	117.765	7.39149	1039.06	0	0
17	120.61	7.82336	1062.59	0	0
18	123.454	8.26749	1078.7	0	0
19	126.299	8.72392	1087.32	0	0
20	129.144	9.19267	1088.43	0	0
21	131.988	9.67377	1082.08	0	0
22	134.833	10.1672	1068.36	0	0
23	137.677	10.6731	1047.41	0	0
24	140.522	11.1914	1019.45	0	0
25	143.367	11.7222	984.716	0	0
26	146.211	12.2654	943.531	0	0
27	150.544	13.1168	869.322	0	0
28	153.42	13.6982	812.956	0	0
29	156.296	14.2925	751.571	0	0
30	159.173	14.8996	685.75	0	0
31	162.049	15.5198	616.136	0	0
32	164.926	16.1529	543.434	0	0
33	167.802	16.799	468.407	0	0
34	170.678	17.4582	391.882	0	0
35	173.555	18.1305	314.744	0	0
36	176.431	18.8159	237.945	0	0
37	179.308	19.5146	162.496	0	0
38	182.184	20.2264	89.4726	0	0
39	185.06	20.9515	20.0155	0	0
40	187.937	21.6899	-44.6708	0	0
41	190.813	22.4417	-103.316	0	0
42	193.69	23.2068	-154.584	0	0
43	196.566	23.9855	-197.07	0	0
44	199.442	24.7776	-229.305	0	0
45	202.319	25.5832	-249.748	0	0
46	205.195	26.4025	-256.791	0	0
47	208.072	27.2353	-248.755	0	0
48	210.948	28.0819	-223.89	0	0
49	213.824	28.9423	-180.373	0	0
50	216.701	29.8164	-116.311	0	0
51	219.577	30.7044	0	0	0

Query 1 (bishop simplified) - Safety Factor: 3.11046

Slice Number	X coordinate [ft]	Y coordinate - Bottom [ft]	Interslice Normal Force [lbs]	Interslice Shear Force [lbs]	Interslice Force Angle [deg]
1	75.0955	2.3719	0	0	0
2	77.9402	2.62211	91.5096	0	0
3	80.7848	2.88431	182.822	0	0
4	83.6294	3.15852	273.096	0	0
5	86.474	3.44475	361.541	0	0
6	89.3187	3.74302	447.42	0	0
7	92.1633	4.05334	530.045	0	0
8	95.0079	4.37572	608.777	0	0
9	97.8526	4.7102	683.033	0	0
10	100.697	5.05677	752.276	0	0
11	103.542	5.41547	816.026	0	0
12	106.386	5.78631	873.849	0	0
13	109.231	6.16931	925.366	0	0
14	112.076	6.56449	970.249	0	0
15	114.92	6.97188	1008.22	0	0
16	117.765	7.39149	1039.06	0	0
17	120.61	7.82336	1062.59	0	0
18	123.454	8.26749	1078.7	0	0
19	126.299	8.72392	1087.32	0	0
20	129.144	9.19267	1088.43	0	0
21	131.988	9.67377	1082.08	0	0
22	134.833	10.1672	1068.36	0	0
23	137.677	10.6731	1047.41	0	0
24	140.522	11.1914	1019.45	0	0
25	143.367	11.7222	984.716	0	0
26	146.211	12.2654	943.531	0	0
27	150.544	13.1168	869.322	0	0
28	153.42	13.6982	812.956	0	0
29	156.296	14.2925	751.571	0	0
30	159.173	14.8996	685.75	0	0
31	162.049	15.5198	616.136	0	0
32	164.926	16.1529	543.434	0	0
33	167.802	16.799	468.407	0	0
34	170.678	17.4582	391.882	0	0
35	173.555	18.1305	314.744	0	0
36	176.431	18.8159	237.945	0	0
37	179.308	19.5146	162.496	0	0
38	182.184	20.2264	89.4726	0	0
39	185.06	20.9515	20.0155	0	0
40	187.937	21.6899	-44.6708	0	0
41	190.813	22.4417	-103.316	0	0
42	193.69	23.2068	-154.584	0	0
43	196.566	23.9855	-197.07	0	0
44	199.442	24.7776	-229.305	0	0
45	202.319	25.5832	-249.748	0	0
46	205.195	26.4025	-256.791	0	0
47	208.072	27.2353	-248.755	0	0
48	210.948	28.0819	-223.89	0	0
49	213.824	28.9423	-180.373	0	0
50	216.701	29.8164	-116.311	0	0
51	219.577	30.7044	0	0	0

◆ Simplified Janbu Method - Effective Stress

Global Minimum Query (bishop simplified) - Safety Factor: 3.11046

Slice Number	X coordinate [ft]	Y coordinate - Bottom [ft]	Interslice Normal Force [lbs]	Interslice Shear Force [lbs]	Interslice Force Angle [deg]
1	75.0955	2.3719	0	0	0
2	77.9402	2.62211	91.5096	0	0
3	80.7848	2.88431	182.822	0	0
4	83.6294	3.15852	273.096	0	0
5	86.474	3.44475	361.541	0	0
6	89.3187	3.74302	447.42	0	0
7	92.1633	4.05334	530.045	0	0
8	95.0079	4.37572	608.777	0	0
9	97.8526	4.7102	683.033	0	0
10	100.697	5.05677	752.276	0	0
11	103.542	5.41547	816.026	0	0
12	106.386	5.78631	873.849	0	0
13	109.231	6.16931	925.366	0	0
14	112.076	6.56449	970.249	0	0
15	114.92	6.97188	1008.22	0	0
16	117.765	7.39149	1039.06	0	0
17	120.61	7.82336	1062.59	0	0
18	123.454	8.26749	1078.7	0	0
19	126.299	8.72392	1087.32	0	0
20	129.144	9.19267	1088.43	0	0
21	131.988	9.67377	1082.08	0	0
22	134.833	10.1672	1068.36	0	0
23	137.677	10.6731	1047.41	0	0
24	140.522	11.1914	1019.45	0	0
25	143.367	11.7222	984.716	0	0
26	146.211	12.2654	943.531	0	0
27	150.544	13.1168	869.322	0	0
28	153.42	13.6982	812.956	0	0
29	156.296	14.2925	751.571	0	0
30	159.173	14.8996	685.75	0	0
31	162.049	15.5198	616.136	0	0
32	164.926	16.1529	543.434	0	0
33	167.802	16.799	468.407	0	0
34	170.678	17.4582	391.882	0	0
35	173.555	18.1305	314.744	0	0
36	176.431	18.8159	237.945	0	0
37	179.308	19.5146	162.496	0	0
38	182.184	20.2264	89.4726	0	0
39	185.06	20.9515	20.0155	0	0
40	187.937	21.6899	-44.6708	0	0
41	190.813	22.4417	-103.316	0	0
42	193.69	23.2068	-154.584	0	0
43	196.566	23.9855	-197.07	0	0
44	199.442	24.7776	-229.305	0	0
45	202.319	25.5832	-249.748	0	0
46	205.195	26.4025	-256.791	0	0
47	208.072	27.2353	-248.755	0	0
48	210.948	28.0819	-223.89	0	0
49	213.824	28.9423	-180.373	0	0
50	216.701	29.8164	-116.311	0	0
51	219.577	30.7044	0	0	0

Query 1 (bishop simplified) - Safety Factor: 3.11046

Slice Number	X coordinate [ft]	Y coordinate - Bottom [ft]	Interslice Normal Force [lbs]	Interslice Shear Force [lbs]	Interslice Force Angle [deg]
1	75.0955	2.3719	0	0	0
2	77.9402	2.62211	91.5096	0	0
3	80.7848	2.88431	182.822	0	0
4	83.6294	3.15852	273.096	0	0
5	86.474	3.44475	361.541	0	0
6	89.3187	3.74302	447.42	0	0
7	92.1633	4.05334	530.045	0	0
8	95.0079	4.37572	608.777	0	0
9	97.8526	4.7102	683.033	0	0
10	100.697	5.05677	752.276	0	0
11	103.542	5.41547	816.026	0	0
12	106.386	5.78631	873.849	0	0
13	109.231	6.16931	925.366	0	0
14	112.076	6.56449	970.249	0	0
15	114.92	6.97188	1008.22	0	0
16	117.765	7.39149	1039.06	0	0
17	120.61	7.82336	1062.59	0	0
18	123.454	8.26749	1078.7	0	0
19	126.299	8.72392	1087.32	0	0
20	129.144	9.19267	1088.43	0	0
21	131.988	9.67377	1082.08	0	0
22	134.833	10.1672	1068.36	0	0
23	137.677	10.6731	1047.41	0	0
24	140.522	11.1914	1019.45	0	0
25	143.367	11.7222	984.716	0	0
26	146.211	12.2654	943.531	0	0
27	150.544	13.1168	869.322	0	0
28	153.42	13.6982	812.956	0	0
29	156.296	14.2925	751.571	0	0
30	159.173	14.8996	685.75	0	0
31	162.049	15.5198	616.136	0	0
32	164.926	16.1529	543.434	0	0
33	167.802	16.799	468.407	0	0
34	170.678	17.4582	391.882	0	0
35	173.555	18.1305	314.744	0	0
36	176.431	18.8159	237.945	0	0
37	179.308	19.5146	162.496	0	0
38	182.184	20.2264	89.4726	0	0
39	185.06	20.9515	20.0155	0	0
40	187.937	21.6899	-44.6708	0	0
41	190.813	22.4417	-103.316	0	0
42	193.69	23.2068	-154.584	0	0
43	196.566	23.9855	-197.07	0	0
44	199.442	24.7776	-229.305	0	0
45	202.319	25.5832	-249.748	0	0
46	205.195	26.4025	-256.791	0	0
47	208.072	27.2353	-248.755	0	0
48	210.948	28.0819	-223.89	0	0
49	213.824	28.9423	-180.373	0	0
50	216.701	29.8164	-116.311	0	0
51	219.577	30.7044	0	0	0

Discharge Sections

Entity Information

◆ Simplified Bishop Method - Effective Stress

Shared Entities

Type	Coordinates (x,y)
External Boundary	0, 0
	0, -11
	0, -150
	532.8, -150
	532.8, -30.9
	532.8, -27.9
	532.8, 49.2
	532.8, 53.2
	528.8, 53.2
	268, 40.2
63, 0	
Material Boundary	63, 0
	72.5, 0
	148, -30.9
	532.8, -27.9
Material Boundary	63, 0
	90.5811, -11
	148, -33.9
	532.8, -30.9
Material Boundary	72.5, 0
	83.8, 0
	268, 36.2
	528, 49.2
	532.8, 49.2
Material Boundary	0, -11
	90.5811, -11

◆ Simplified Janbu Method - Effective Stress

Shared Entities

Type	Coordinates (x,y)
External Boundary	0, 0 0, -11 0, -150 532.8, -150 532.8, -30.9 532.8, -29.4243 532.8, -27.9 532.8, 49.2 532.8, 53.2 528.8, 53.2 268, 40.2 63, 0
Material Boundary	63, 0 68.213, 0 72.5, 0 148, -30.9 532.8, -27.9
Material Boundary	63, 0 90.5811, -11 148, -33.9 532.8, -30.9
Material Boundary	72.5, 0 83.8, 0 268, 36.2 528, 49.2 532.8, 49.2
Material Boundary	0, -11 90.5811, -11
Material Boundary	68.213, 0 147.921, -32.362 532.8, -29.4243

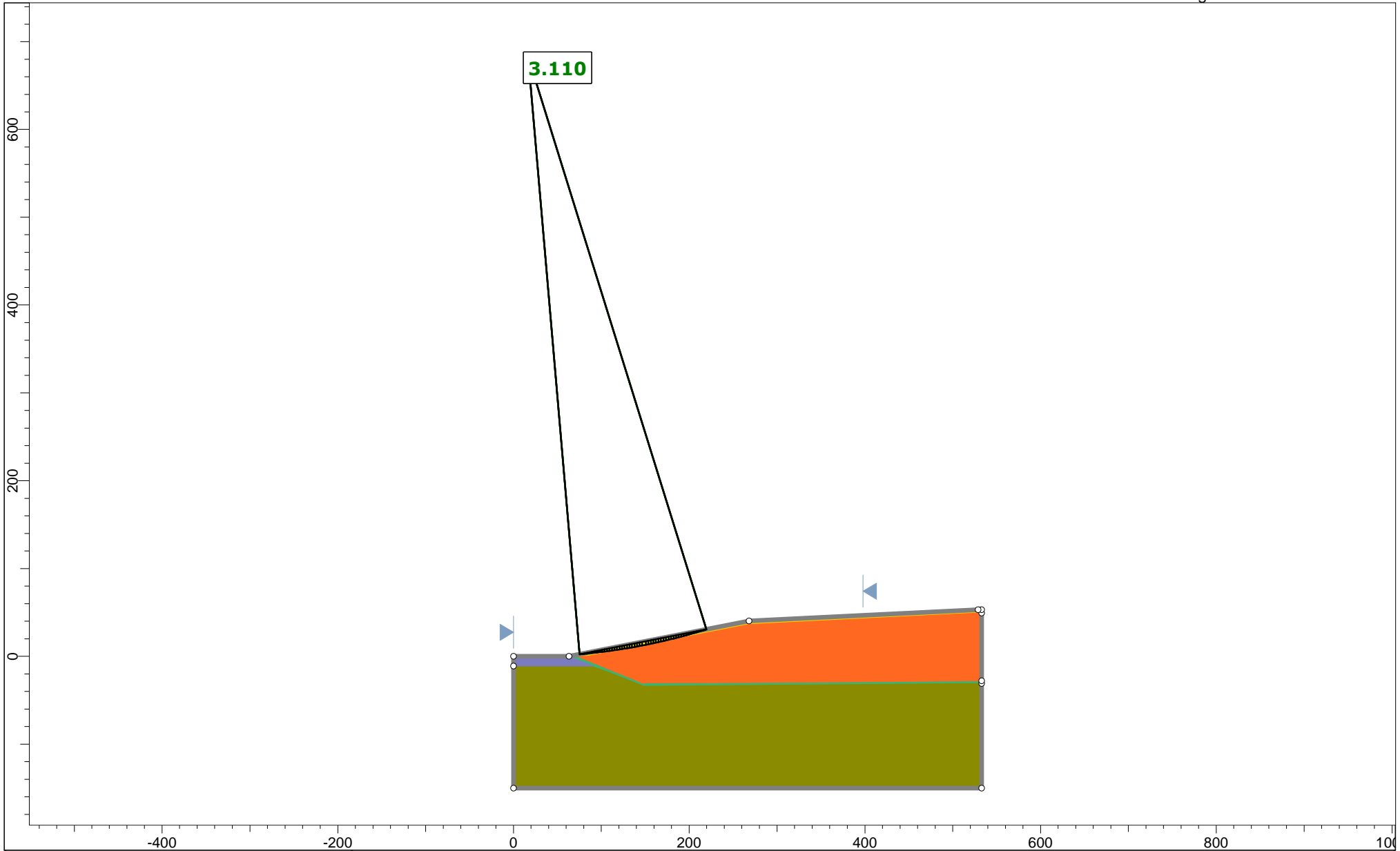

 <small>SLIDEINTERPRET 9.018</small>	<i>Project</i> SLIDE - An Interactive Slope Stability Program	
	<i>Group</i> Simplified Bishop Method - Total Stress	<i>Scenario</i> Master Scenario
	<i>Drawn By</i>	<i>Company</i>
	<i>Date</i>	<i>File Name</i> Slide2-FC Section D_Total Stress.slmd

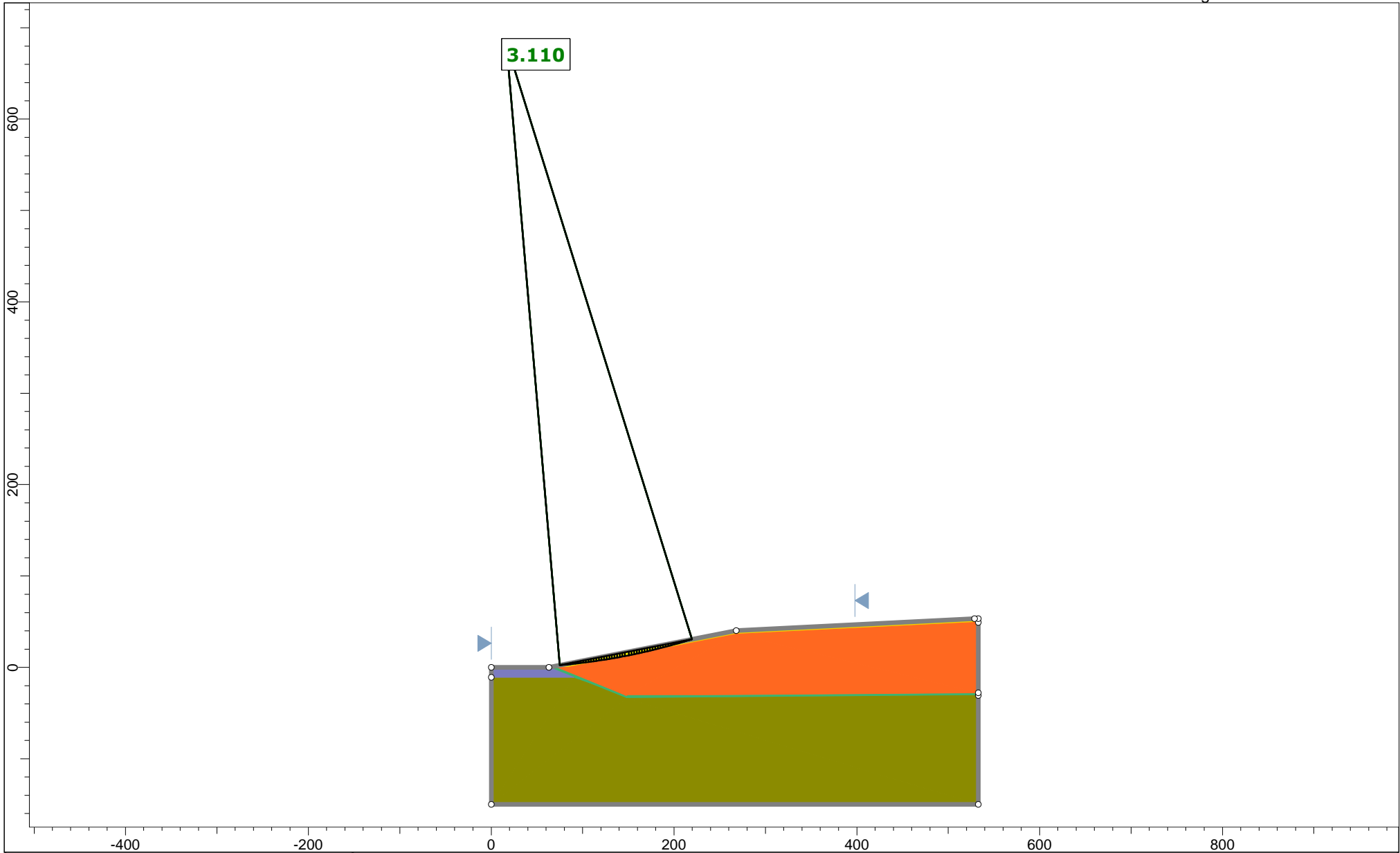

	<i>Project</i> SLIDE - An Interactive Slope Stability Program	
	<i>Group</i> Simplified Janbu Method - Total Stress	<i>Scenario</i> Master Scenario
	<i>Drawn By</i>	<i>Company</i>
	<i>Date</i>	<i>File Name</i> Slide2-FC Section D_Total Stress.slmd

Materials

Final Cover

Color	
Strength Type	Mohr-Coulomb
Unit Weight [lbs/ft ³]	120
Cohesion [psf]	100
Friction Angle [deg]	16
Water Surface	Assigned per scenario
Ru Value	0

Liner

Color	
Strength Type	Mohr-Coulomb
Unit Weight [lbs/ft ³]	116
Cohesion [psf]	1000
Friction Angle [deg]	0
Water Surface	Assigned per scenario
Ru Value	0

Waste

Color	
Strength Type	Mohr-Coulomb
Unit Weight [lbs/ft ³]	47
Cohesion [psf]	288
Friction Angle [deg]	23
Water Surface	Assigned per scenario
Ru Value	0





Stratum II

Color	
Strength Type	Mohr-Coulomb
Unit Weight [lbs/ft ³]	110.9
Cohesion [psf]	206
Friction Angle [deg]	26
Water Surface	Assigned per scenario
Ru Value	0

Stratum III

Color	
Strength Type	Mohr-Coulomb
Unit Weight [lbs/ft ³]	109
Cohesion [psf]	150
Friction Angle [deg]	24
Water Surface	Assigned per scenario
Ru Value	0

Materials In Use

Material		Simplified Bishop Method - Total Stress	Simplified Janbu Method - Total Stress
Final Cover		✓	✓
Liner		✓	✓
Waste		✓	✓
Stratum II		✓	✓
Stratum III		✓	✓

Global Minimums

◆ Simplified Bishop Method - Total Stress

Method: bishop simplified

FS	3.110460
Center:	16.676, 682.842
Radius:	682.974
Left Slip Surface Endpoint:	75.096, 2.372
Right Slip Surface Endpoint:	219.577, 30.704
Resisting Moment:	1.9096e+07 lb-ft
Driving Moment:	6.13928e+06 lb-ft
Total Slice Area:	390.64 ft ²
Surface Horizontal Width:	144.482 ft
Surface Average Height:	2.70373 ft

◆ Simplified Janbu Method - Total Stress

Method: bishop simplified

FS	3.110460
Center:	16.676, 682.842
Radius:	682.974
Left Slip Surface Endpoint:	75.096, 2.372
Right Slip Surface Endpoint:	219.577, 30.704
Resisting Moment:	1.9096e+07 lb-ft
Driving Moment:	6.13928e+06 lb-ft
Total Slice Area:	390.64 ft ²
Surface Horizontal Width:	144.482 ft
Surface Average Height:	2.70373 ft

Valid and Invalid Surfaces

◆ Simplified Bishop Method - Total Stress

Method: bishop simplified

Number of Valid Surfaces:	10945
Number of Invalid Surfaces:	0

◆ Simplified Janbu Method - Total Stress

Method: bishop simplified

Number of Valid Surfaces:	10945
Number of Invalid Surfaces:	0

Slice Data

◆ Simplified Bishop Method - Total Stress

Global Minimum Query (bishop simplified) - Safety Factor: 3.11046

Slice Number	Width [ft]	Weight [lbs]	Angle of Slice Base [deg]	Base Material	Base Cohesion [psf]	Base Friction Angle [deg]	Shear Stress [psf]	Shear Strength [psf]	Base Normal Stress [psf]	Pore Pressure [psf]	Effective Normal Stress [psf]	Base Vertical Stress [psf]	Effective Vertical Stress [psf]
1	2.84463	52.5032	5.02672	Final Cover	100	16	33.5792	104.447	15.5074	0	15.5074	18.461	18.461
2	2.84463	155.463	5.26632	Final Cover	100	16	36.8748	114.698	51.2569	0	51.2569	54.6558	54.6558
3	2.84463	254.326	5.50602	Final Cover	100	16	40.0364	124.531	85.5517	0	85.5517	89.411	89.411
4	2.84463	349.088	5.74582	Final Cover	100	16	43.0638	133.948	118.391	0	118.391	122.724	122.724
5	2.84463	439.745	5.98572	Final Cover	100	16	45.957	142.947	149.776	0	149.776	154.594	154.594
6	2.84463	526.29	6.22572	Final Cover	100	16	48.7161	151.529	179.705	0	179.705	185.019	185.019
7	2.84463	608.718	6.46583	Final Cover	100	16	51.341	159.694	208.178	0	208.178	213.996	213.996
8	2.84463	687.023	6.70606	Final Cover	100	16	53.8316	167.441	235.195	0	235.195	241.525	241.525
9	2.84463	761.2	6.9464	Final Cover	100	16	56.188	174.77	260.756	0	260.756	267.602	267.602
10	2.84463	831.242	7.18687	Final Cover	100	16	58.41	181.682	284.859	0	284.859	292.225	292.225
11	2.84463	897.143	7.42747	Final Cover	100	16	60.4977	188.176	307.505	0	307.505	315.392	315.392
12	2.84463	958.896	7.6682	Final Cover	100	16	62.451	194.251	328.693	0	328.693	337.101	337.101
13	2.84463	1016.49	7.90906	Final Cover	100	16	64.2697	199.908	348.422	0	348.422	357.35	357.35
14	2.84463	1069.93	8.15006	Final Cover	100	16	65.9539	205.147	366.69	0	366.69	376.135	376.135
15	2.84463	1119.2	8.39121	Final Cover	100	16	67.5032	209.966	383.496	0	383.496	393.454	393.454
16	2.84463	1164.28	8.63251	Final Cover	100	16	68.9181	214.367	398.843	0	398.843	409.305	409.305
17	2.84463	1205.19	8.87397	Final Cover	100	16	70.1977	218.347	412.727	0	412.727	423.687	423.687
18	2.84463	1241.9	9.11558	Final Cover	100	16	71.3425	221.908	425.145	0	425.145	436.592	436.592
19	2.84463	1274.41	9.35735	Final Cover	100	16	72.3523	225.049	436.099	0	436.099	448.021	448.021
20	2.84463	1302.71	9.5993	Final Cover	100	16	73.2271	227.77	445.587	0	445.587	457.971	457.971
21	2.84463	1326.79	9.84142	Final Cover	100	16	73.9662	230.069	453.605	0	453.605	466.436	466.436
22	2.84463	1346.64	10.0837	Final Cover	100	16	74.57	231.947	460.152	0	460.152	473.413	473.413
23	2.84463	1362.25	10.3262	Final Cover	100	16	75.0381	233.403	465.232	0	465.232	478.904	478.904
24	2.84463	1373.62	10.5689	Final Cover	100	16	75.3705	234.437	468.836	0	468.836	482.898	482.898
25	2.84463	1380.73	10.8117	Final Cover	100	16	75.567	235.048	470.968	0	470.968	485.399	485.399
26	4.33239	2106.16	11.1184	Final Cover	100	16	75.5981	235.145	471.306	0	471.306	486.163	486.163
27	2.87639	1395.03	11.4267	Final Cover	100	16	75.4557	234.702	469.761	0	469.761	485.012	485.012
28	2.87639	1386.83	11.673	Final Cover	100	16	75.1673	233.805	466.631	0	466.631	482.161	482.161
29	2.87639	1374.17	11.9195	Final Cover	100	16	74.7391	232.473	461.987	0	461.987	477.764	477.764

Slide2-FC Section D_Total Stress

Permit Page - IILL-1912

30	2.87639	1357.05	12.1662	Final Cover	100	16	74.1707	230.705	455.823	0	455.823	471.814	471.814
31	2.87639	1335.46	12.4132	Final Cover	100	16	73.4621	228.501	448.136	0	448.136	464.306	464.306
32	2.87639	1309.37	12.6604	Final Cover	100	16	72.6131	225.86	438.924	0	438.924	455.236	455.236
33	2.87639	1278.79	12.9078	Final Cover	100	16	71.6232	222.781	428.189	0	428.189	444.604	444.604
34	2.87639	1243.69	13.1555	Final Cover	100	16	70.4925	219.264	415.923	0	415.923	432.399	432.399
35	2.87639	1204.06	13.4035	Final Cover	100	16	69.2206	215.308	402.13	0	402.13	418.625	418.625
36	2.87639	1159.89	13.6516	Final Cover	100	16	67.8073	210.912	386.799	0	386.799	403.268	403.268
37	2.87639	1111.16	13.9001	Final Cover	100	16	66.2523	206.075	369.929	0	369.929	386.325	386.325
38	2.87639	1057.86	14.1488	Final Cover	100	16	64.5554	200.797	351.519	0	351.519	367.793	367.793
39	2.87639	999.97	14.3978	Final Cover	100	16	62.7161	195.076	331.569	0	331.569	347.669	347.669
40	2.87639	937.482	14.6471	Final Cover	100	16	60.7343	188.911	310.071	0	310.071	325.945	325.945
41	2.87639	870.377	14.8966	Final Cover	100	16	58.6095	182.303	287.023	0	287.023	302.615	302.615
42	2.87639	798.638	15.1465	Final Cover	100	16	56.3416	175.248	262.422	0	262.422	277.673	277.673
43	2.87639	722.25	15.3966	Final Cover	100	16	53.9302	167.748	236.265	0	236.265	251.116	251.116
44	2.87639	641.196	15.6471	Final Cover	100	16	51.375	159.8	208.547	0	208.547	222.937	222.937
45	2.87639	555.459	15.8978	Final Cover	100	16	48.6756	151.404	179.265	0	179.265	193.129	193.129
46	2.87639	465.022	16.1489	Final Cover	100	16	45.8316	142.558	148.416	0	148.416	161.687	161.687
47	2.87639	369.866	16.4002	Final Cover	100	16	42.8428	133.261	115.995	0	115.995	128.604	128.604
48	2.87639	269.974	16.6519	Final Cover	100	16	39.7088	123.513	81.9979	0	81.9979	93.8748	93.8748
49	2.87639	165.327	16.904	Final Cover	100	16	36.4291	113.311	46.4218	0	46.4218	57.4925	57.4925
50	2.87639	55.9063	17.1564	Final Cover	100	16	33.0034	102.656	9.26151	0	9.26151	19.4502	19.4502

Query 1 (bishop simplified) - Safety Factor: 3.11046

Slice Number	Width [ft]	Weight [lbs]	Angle of Slice Base [deg]	Base Material	Base Cohesion [psf]	Base Friction Angle [deg]	Shear Stress [psf]	Shear Strength [psf]	Base Normal Stress [psf]	Pore Pressure [psf]	Effective Normal Stress [psf]	Base Vertical Stress [psf]	Effective Vertical Stress [psf]
1	2.84463	52.5032	5.02672	Final Cover	100	16	33.5792	104.447	15.5074	0	15.5074	18.461	18.461
2	2.84463	155.463	5.26632	Final Cover	100	16	36.8748	114.698	51.2569	0	51.2569	54.6558	54.6558
3	2.84463	254.326	5.50602	Final Cover	100	16	40.0364	124.531	85.5517	0	85.5517	89.411	89.411
4	2.84463	349.088	5.74582	Final Cover	100	16	43.0638	133.948	118.391	0	118.391	122.724	122.724
5	2.84463	439.745	5.98572	Final Cover	100	16	45.957	142.947	149.776	0	149.776	154.594	154.594
6	2.84463	526.29	6.22572	Final Cover	100	16	48.7161	151.529	179.705	0	179.705	185.019	185.019
7	2.84463	608.718	6.46583	Final Cover	100	16	51.341	159.694	208.178	0	208.178	213.996	213.996
8	2.84463	687.023	6.70606	Final Cover	100	16	53.8316	167.441	235.195	0	235.195	241.525	241.525
9	2.84463	761.2	6.9464	Final Cover	100	16	56.188	174.77	260.756	0	260.756	267.602	267.602
10	2.84463	831.242	7.18687	Final Cover	100	16	58.41	181.682	284.859	0	284.859	292.225	292.225
11	2.84463	897.143	7.42747	Final Cover	100	16	60.4977	188.176	307.505	0	307.505	315.392	315.392
12	2.84463	958.896	7.6682	Final Cover	100	16	62.451	194.251	328.693	0	328.693	337.101	337.101
13	2.84463	1016.49	7.90906	Final Cover	100	16	64.2697	199.908	348.422	0	348.422	357.35	357.35
14	2.84463	1069.93	8.15006	Final Cover	100	16	65.9539	205.147	366.69	0	366.69	376.135	376.135
15	2.84463	1119.2	8.39121	Final Cover	100	16	67.5032	209.966	383.496	0	383.496	393.454	393.454
16	2.84463	1164.28	8.63251	Final Cover	100	16	68.9181	214.367	398.843	0	398.843	409.305	409.305
17	2.84463	1205.19	8.87397	Final Cover	100	16	70.1977	218.347	412.727	0	412.727	423.687	423.687
18	2.84463	1241.9	9.11558	Final Cover	100	16	71.3425	221.908	425.145	0	425.145	436.592	436.592
19	2.84463	1274.41	9.35735	Final Cover	100	16	72.3523	225.049	436.099	0	436.099	448.021	448.021
20	2.84463	1302.71	9.5993	Final Cover	100	16	73.2271	227.77	445.587	0	445.587	457.971	457.971
21	2.84463	1326.79	9.84142	Final Cover	100	16	73.9662	230.069	453.605	0	453.605	466.436	466.436
22	2.84463	1346.64	10.0837	Final Cover	100	16	74.57	231.947	460.152	0	460.152	473.413	473.413
23	2.84463	1362.25	10.3262	Final Cover	100	16	75.0381	233.403	465.232	0	465.232	478.904	478.904
24	2.84463	1373.62	10.5689	Final Cover	100	16	75.3705	234.437	468.836	0	468.836	482.898	482.898
25	2.84463	1380.73	10.8117	Final Cover	100	16	75.567	235.048	470.968	0	470.968	485.399	485.399
26	4.33239	2106.16	11.1184	Final Cover	100	16	75.5981	235.145	471.306	0	471.306	486.163	486.163
27	2.87639	1395.03	11.4267	Final Cover	100	16	75.4557	234.702	469.761	0	469.761	485.012	485.012
28	2.87639	1386.83	11.673	Final Cover	100	16	75.1673	233.805	466.631	0	466.631	482.161	482.161
29	2.87639	1374.17	11.9195	Final Cover	100	16	74.7391	232.473	461.987	0	461.987	477.764	477.764
30	2.87639	1357.05	12.1662	Final Cover	100	16	74.1707	230.705	455.823	0	455.823	471.814	471.814
31	2.87639	1335.46	12.4132	Final Cover	100	16	73.4621	228.501	448.136	0	448.136	464.306	464.306
32	2.87639	1309.37	12.6604	Final Cover	100	16	72.6131	225.86	438.924	0	438.924	455.236	455.236
33	2.87639	1278.79	12.9078	Final Cover	100	16	71.6232	222.781	428.189	0	428.189	444.604	444.604

Slide2-FC Section D_Total Stress

Permit Page - IILL-1914

34	2.87639	1243.69	13.1555	Final Cover	100	16	70.4925	219.264	415.923	0	415.923	432.399	432.399
35	2.87639	1204.06	13.4035	Final Cover	100	16	69.2206	215.308	402.13	0	402.13	418.625	418.625
36	2.87639	1159.89	13.6516	Final Cover	100	16	67.8073	210.912	386.799	0	386.799	403.268	403.268
37	2.87639	1111.16	13.9001	Final Cover	100	16	66.2523	206.075	369.929	0	369.929	386.325	386.325
38	2.87639	1057.86	14.1488	Final Cover	100	16	64.5554	200.797	351.519	0	351.519	367.793	367.793
39	2.87639	999.97	14.3978	Final Cover	100	16	62.7161	195.076	331.569	0	331.569	347.669	347.669
40	2.87639	937.482	14.6471	Final Cover	100	16	60.7343	188.911	310.071	0	310.071	325.945	325.945
41	2.87639	870.377	14.8966	Final Cover	100	16	58.6095	182.303	287.023	0	287.023	302.615	302.615
42	2.87639	798.638	15.1465	Final Cover	100	16	56.3416	175.248	262.422	0	262.422	277.673	277.673
43	2.87639	722.25	15.3966	Final Cover	100	16	53.9302	167.748	236.265	0	236.265	251.116	251.116
44	2.87639	641.196	15.6471	Final Cover	100	16	51.375	159.8	208.547	0	208.547	222.937	222.937
45	2.87639	555.459	15.8978	Final Cover	100	16	48.6756	151.404	179.265	0	179.265	193.129	193.129
46	2.87639	465.022	16.1489	Final Cover	100	16	45.8316	142.558	148.416	0	148.416	161.687	161.687
47	2.87639	369.866	16.4002	Final Cover	100	16	42.8428	133.261	115.995	0	115.995	128.604	128.604
48	2.87639	269.974	16.6519	Final Cover	100	16	39.7088	123.513	81.9979	0	81.9979	93.8748	93.8748
49	2.87639	165.327	16.904	Final Cover	100	16	36.4291	113.311	46.4218	0	46.4218	57.4925	57.4925
50	2.87639	55.9063	17.1564	Final Cover	100	16	33.0034	102.656	9.26151	0	9.26151	19.4502	19.4502

◆ Simplified Janbu Method - Total Stress

Global Minimum Query (bishop simplified) - Safety Factor: 3.11046

Slice Number	Width [ft]	Weight [lbs]	Angle of Slice Base [deg]	Base Material	Base Cohesion [psf]	Base Friction Angle [deg]	Shear Stress [psf]	Shear Strength [psf]	Base Normal Stress [psf]	Pore Pressure [psf]	Effective Normal Stress [psf]	Base Vertical Stress [psf]	Effective Vertical Stress [psf]
1	2.84463	52.5032	5.02672	Final Cover	100	16	33.5792	104.447	15.5074	0	15.5074	18.461	18.461
2	2.84463	155.463	5.26632	Final Cover	100	16	36.8748	114.698	51.2569	0	51.2569	54.6558	54.6558
3	2.84463	254.326	5.50602	Final Cover	100	16	40.0364	124.531	85.5517	0	85.5517	89.411	89.411
4	2.84463	349.088	5.74582	Final Cover	100	16	43.0638	133.948	118.391	0	118.391	122.724	122.724
5	2.84463	439.745	5.98572	Final Cover	100	16	45.957	142.947	149.776	0	149.776	154.594	154.594
6	2.84463	526.29	6.22572	Final Cover	100	16	48.7161	151.529	179.705	0	179.705	185.019	185.019
7	2.84463	608.718	6.46583	Final Cover	100	16	51.341	159.694	208.178	0	208.178	213.996	213.996
8	2.84463	687.023	6.70606	Final Cover	100	16	53.8316	167.441	235.195	0	235.195	241.525	241.525
9	2.84463	761.2	6.9464	Final Cover	100	16	56.188	174.77	260.756	0	260.756	267.602	267.602
10	2.84463	831.242	7.18687	Final Cover	100	16	58.41	181.682	284.859	0	284.859	292.225	292.225
11	2.84463	897.143	7.42747	Final Cover	100	16	60.4977	188.176	307.505	0	307.505	315.392	315.392
12	2.84463	958.896	7.6682	Final Cover	100	16	62.451	194.251	328.693	0	328.693	337.101	337.101
13	2.84463	1016.49	7.90906	Final Cover	100	16	64.2697	199.908	348.422	0	348.422	357.35	357.35
14	2.84463	1069.93	8.15006	Final Cover	100	16	65.9539	205.147	366.69	0	366.69	376.135	376.135
15	2.84463	1119.2	8.39121	Final Cover	100	16	67.5032	209.966	383.496	0	383.496	393.454	393.454
16	2.84463	1164.28	8.63251	Final Cover	100	16	68.9181	214.367	398.843	0	398.843	409.305	409.305
17	2.84463	1205.19	8.87397	Final Cover	100	16	70.1977	218.347	412.727	0	412.727	423.687	423.687
18	2.84463	1241.9	9.11558	Final Cover	100	16	71.3425	221.908	425.145	0	425.145	436.592	436.592
19	2.84463	1274.41	9.35735	Final Cover	100	16	72.3523	225.049	436.099	0	436.099	448.021	448.021
20	2.84463	1302.71	9.5993	Final Cover	100	16	73.2271	227.77	445.587	0	445.587	457.971	457.971
21	2.84463	1326.79	9.84142	Final Cover	100	16	73.9662	230.069	453.605	0	453.605	466.436	466.436
22	2.84463	1346.64	10.0837	Final Cover	100	16	74.57	231.947	460.152	0	460.152	473.413	473.413
23	2.84463	1362.25	10.3262	Final Cover	100	16	75.0381	233.403	465.232	0	465.232	478.904	478.904
24	2.84463	1373.62	10.5689	Final Cover	100	16	75.3705	234.437	468.836	0	468.836	482.898	482.898
25	2.84463	1380.73	10.8117	Final Cover	100	16	75.567	235.048	470.968	0	470.968	485.399	485.399
26	4.33239	2106.16	11.1184	Final Cover	100	16	75.5981	235.145	471.306	0	471.306	486.163	486.163
27	2.87639	1395.03	11.4267	Final Cover	100	16	75.4557	234.702	469.761	0	469.761	485.012	485.012
28	2.87639	1386.83	11.673	Final Cover	100	16	75.1673	233.805	466.631	0	466.631	482.161	482.161
29	2.87639	1374.17	11.9195	Final Cover	100	16	74.7391	232.473	461.987	0	461.987	477.764	477.764
30	2.87639	1357.05	12.1662	Final Cover	100	16	74.1707	230.705	455.823	0	455.823	471.814	471.814
31	2.87639	1335.46	12.4132	Final Cover	100	16	73.4621	228.501	448.136	0	448.136	464.306	464.306
32	2.87639	1309.37	12.6604	Final Cover	100	16	72.6131	225.86	438.924	0	438.924	455.236	455.236

Slide2-FC Section D_Total Stress

Permit Page - IILL-1916

33	2.87639	1278.79	12.9078	Final Cover	100	16	71.6232	222.781	428.189	0	428.189	444.604	444.604
34	2.87639	1243.69	13.1555	Final Cover	100	16	70.4925	219.264	415.923	0	415.923	432.399	432.399
35	2.87639	1204.06	13.4035	Final Cover	100	16	69.2206	215.308	402.13	0	402.13	418.625	418.625
36	2.87639	1159.89	13.6516	Final Cover	100	16	67.8073	210.912	386.799	0	386.799	403.268	403.268
37	2.87639	1111.16	13.9001	Final Cover	100	16	66.2523	206.075	369.929	0	369.929	386.325	386.325
38	2.87639	1057.86	14.1488	Final Cover	100	16	64.5554	200.797	351.519	0	351.519	367.793	367.793
39	2.87639	999.97	14.3978	Final Cover	100	16	62.7161	195.076	331.569	0	331.569	347.669	347.669
40	2.87639	937.482	14.6471	Final Cover	100	16	60.7343	188.911	310.071	0	310.071	325.945	325.945
41	2.87639	870.377	14.8966	Final Cover	100	16	58.6095	182.303	287.023	0	287.023	302.615	302.615
42	2.87639	798.638	15.1465	Final Cover	100	16	56.3416	175.248	262.422	0	262.422	277.673	277.673
43	2.87639	722.25	15.3966	Final Cover	100	16	53.9302	167.748	236.265	0	236.265	251.116	251.116
44	2.87639	641.196	15.6471	Final Cover	100	16	51.375	159.8	208.547	0	208.547	222.937	222.937
45	2.87639	555.459	15.8978	Final Cover	100	16	48.6756	151.404	179.265	0	179.265	193.129	193.129
46	2.87639	465.022	16.1489	Final Cover	100	16	45.8316	142.558	148.416	0	148.416	161.687	161.687
47	2.87639	369.866	16.4002	Final Cover	100	16	42.8428	133.261	115.995	0	115.995	128.604	128.604
48	2.87639	269.974	16.6519	Final Cover	100	16	39.7088	123.513	81.9979	0	81.9979	93.8748	93.8748
49	2.87639	165.327	16.904	Final Cover	100	16	36.4291	113.311	46.4218	0	46.4218	57.4925	57.4925
50	2.87639	55.9063	17.1564	Final Cover	100	16	33.0034	102.656	9.26151	0	9.26151	19.4502	19.4502

Query 1 (bishop simplified) - Safety Factor: 3.11046

Slice Number	Width [ft]	Weight [lbs]	Angle of Slice Base [deg]	Base Material	Base Cohesion [psf]	Base Friction Angle [deg]	Shear Stress [psf]	Shear Strength [psf]	Base Normal Stress [psf]	Pore Pressure [psf]	Effective Normal Stress [psf]	Base Vertical Stress [psf]	Effective Vertical Stress [psf]
1	2.84463	52.5032	5.02672	Final Cover	100	16	33.5792	104.447	15.5074	0	15.5074	18.461	18.461
2	2.84463	155.463	5.26632	Final Cover	100	16	36.8748	114.698	51.2569	0	51.2569	54.6558	54.6558
3	2.84463	254.326	5.50602	Final Cover	100	16	40.0364	124.531	85.5517	0	85.5517	89.411	89.411
4	2.84463	349.088	5.74582	Final Cover	100	16	43.0638	133.948	118.391	0	118.391	122.724	122.724
5	2.84463	439.745	5.98572	Final Cover	100	16	45.957	142.947	149.776	0	149.776	154.594	154.594
6	2.84463	526.29	6.22572	Final Cover	100	16	48.7161	151.529	179.705	0	179.705	185.019	185.019
7	2.84463	608.718	6.46583	Final Cover	100	16	51.341	159.694	208.178	0	208.178	213.996	213.996
8	2.84463	687.023	6.70606	Final Cover	100	16	53.8316	167.441	235.195	0	235.195	241.525	241.525
9	2.84463	761.2	6.9464	Final Cover	100	16	56.188	174.77	260.756	0	260.756	267.602	267.602
10	2.84463	831.242	7.18687	Final Cover	100	16	58.41	181.682	284.859	0	284.859	292.225	292.225
11	2.84463	897.143	7.42747	Final Cover	100	16	60.4977	188.176	307.505	0	307.505	315.392	315.392
12	2.84463	958.896	7.6682	Final Cover	100	16	62.451	194.251	328.693	0	328.693	337.101	337.101
13	2.84463	1016.49	7.90906	Final Cover	100	16	64.2697	199.908	348.422	0	348.422	357.35	357.35
14	2.84463	1069.93	8.15006	Final Cover	100	16	65.9539	205.147	366.69	0	366.69	376.135	376.135
15	2.84463	1119.2	8.39121	Final Cover	100	16	67.5032	209.966	383.496	0	383.496	393.454	393.454
16	2.84463	1164.28	8.63251	Final Cover	100	16	68.9181	214.367	398.843	0	398.843	409.305	409.305
17	2.84463	1205.19	8.87397	Final Cover	100	16	70.1977	218.347	412.727	0	412.727	423.687	423.687
18	2.84463	1241.9	9.11558	Final Cover	100	16	71.3425	221.908	425.145	0	425.145	436.592	436.592
19	2.84463	1274.41	9.35735	Final Cover	100	16	72.3523	225.049	436.099	0	436.099	448.021	448.021
20	2.84463	1302.71	9.5993	Final Cover	100	16	73.2271	227.77	445.587	0	445.587	457.971	457.971
21	2.84463	1326.79	9.84142	Final Cover	100	16	73.9662	230.069	453.605	0	453.605	466.436	466.436
22	2.84463	1346.64	10.0837	Final Cover	100	16	74.57	231.947	460.152	0	460.152	473.413	473.413
23	2.84463	1362.25	10.3262	Final Cover	100	16	75.0381	233.403	465.232	0	465.232	478.904	478.904
24	2.84463	1373.62	10.5689	Final Cover	100	16	75.3705	234.437	468.836	0	468.836	482.898	482.898
25	2.84463	1380.73	10.8117	Final Cover	100	16	75.567	235.048	470.968	0	470.968	485.399	485.399
26	4.33239	2106.16	11.1184	Final Cover	100	16	75.5981	235.145	471.306	0	471.306	486.163	486.163
27	2.87639	1395.03	11.4267	Final Cover	100	16	75.4557	234.702	469.761	0	469.761	485.012	485.012
28	2.87639	1386.83	11.673	Final Cover	100	16	75.1673	233.805	466.631	0	466.631	482.161	482.161
29	2.87639	1374.17	11.9195	Final Cover	100	16	74.7391	232.473	461.987	0	461.987	477.764	477.764
30	2.87639	1357.05	12.1662	Final Cover	100	16	74.1707	230.705	455.823	0	455.823	471.814	471.814
31	2.87639	1335.46	12.4132	Final Cover	100	16	73.4621	228.501	448.136	0	448.136	464.306	464.306
32	2.87639	1309.37	12.6604	Final Cover	100	16	72.6131	225.86	438.924	0	438.924	455.236	455.236
33	2.87639	1278.79	12.9078	Final Cover	100	16	71.6232	222.781	428.189	0	428.189	444.604	444.604

Slide2-FC Section D_Total Stress

Permit Page - IILL-1918

34	2.87639	1243.69	13.1555	Final Cover	100	16	70.4925	219.264	415.923	0	415.923	432.399	432.399
35	2.87639	1204.06	13.4035	Final Cover	100	16	69.2206	215.308	402.13	0	402.13	418.625	418.625
36	2.87639	1159.89	13.6516	Final Cover	100	16	67.8073	210.912	386.799	0	386.799	403.268	403.268
37	2.87639	1111.16	13.9001	Final Cover	100	16	66.2523	206.075	369.929	0	369.929	386.325	386.325
38	2.87639	1057.86	14.1488	Final Cover	100	16	64.5554	200.797	351.519	0	351.519	367.793	367.793
39	2.87639	999.97	14.3978	Final Cover	100	16	62.7161	195.076	331.569	0	331.569	347.669	347.669
40	2.87639	937.482	14.6471	Final Cover	100	16	60.7343	188.911	310.071	0	310.071	325.945	325.945
41	2.87639	870.377	14.8966	Final Cover	100	16	58.6095	182.303	287.023	0	287.023	302.615	302.615
42	2.87639	798.638	15.1465	Final Cover	100	16	56.3416	175.248	262.422	0	262.422	277.673	277.673
43	2.87639	722.25	15.3966	Final Cover	100	16	53.9302	167.748	236.265	0	236.265	251.116	251.116
44	2.87639	641.196	15.6471	Final Cover	100	16	51.375	159.8	208.547	0	208.547	222.937	222.937
45	2.87639	555.459	15.8978	Final Cover	100	16	48.6756	151.404	179.265	0	179.265	193.129	193.129
46	2.87639	465.022	16.1489	Final Cover	100	16	45.8316	142.558	148.416	0	148.416	161.687	161.687
47	2.87639	369.866	16.4002	Final Cover	100	16	42.8428	133.261	115.995	0	115.995	128.604	128.604
48	2.87639	269.974	16.6519	Final Cover	100	16	39.7088	123.513	81.9979	0	81.9979	93.8748	93.8748
49	2.87639	165.327	16.904	Final Cover	100	16	36.4291	113.311	46.4218	0	46.4218	57.4925	57.4925
50	2.87639	55.9063	17.1564	Final Cover	100	16	33.0034	102.656	9.26151	0	9.26151	19.4502	19.4502

Interslice Data

◆ Simplified Bishop Method - Total Stress

Global Minimum Query (bishop simplified) - Safety Factor: 3.11046

Slice Number	X coordinate [ft]	Y coordinate - Bottom [ft]	Interslice Normal Force [lbs]	Interslice Shear Force [lbs]	Interslice Force Angle [deg]
1	75.0955	2.3719	0	0	0
2	77.9402	2.62211	91.5096	0	0
3	80.7848	2.88431	182.822	0	0
4	83.6294	3.15852	273.096	0	0
5	86.474	3.44475	361.541	0	0
6	89.3187	3.74302	447.42	0	0
7	92.1633	4.05334	530.045	0	0
8	95.0079	4.37572	608.777	0	0
9	97.8526	4.7102	683.033	0	0
10	100.697	5.05677	752.276	0	0
11	103.542	5.41547	816.026	0	0
12	106.386	5.78631	873.849	0	0
13	109.231	6.16931	925.366	0	0
14	112.076	6.56449	970.249	0	0
15	114.92	6.97188	1008.22	0	0
16	117.765	7.39149	1039.06	0	0
17	120.61	7.82336	1062.59	0	0
18	123.454	8.26749	1078.7	0	0
19	126.299	8.72392	1087.32	0	0
20	129.144	9.19267	1088.43	0	0
21	131.988	9.67377	1082.08	0	0
22	134.833	10.1672	1068.36	0	0
23	137.677	10.6731	1047.41	0	0
24	140.522	11.1914	1019.45	0	0
25	143.367	11.7222	984.716	0	0
26	146.211	12.2654	943.531	0	0
27	150.544	13.1168	869.322	0	0
28	153.42	13.6982	812.956	0	0
29	156.296	14.2925	751.571	0	0
30	159.173	14.8996	685.75	0	0
31	162.049	15.5198	616.136	0	0
32	164.926	16.1529	543.434	0	0
33	167.802	16.799	468.407	0	0
34	170.678	17.4582	391.882	0	0
35	173.555	18.1305	314.744	0	0
36	176.431	18.8159	237.945	0	0
37	179.308	19.5146	162.496	0	0
38	182.184	20.2264	89.4726	0	0
39	185.06	20.9515	20.0155	0	0
40	187.937	21.6899	-44.6708	0	0
41	190.813	22.4417	-103.316	0	0
42	193.69	23.2068	-154.584	0	0
43	196.566	23.9855	-197.07	0	0
44	199.442	24.7776	-229.305	0	0
45	202.319	25.5832	-249.748	0	0
46	205.195	26.4025	-256.791	0	0
47	208.072	27.2353	-248.755	0	0
48	210.948	28.0819	-223.89	0	0
49	213.824	28.9423	-180.373	0	0
50	216.701	29.8164	-116.311	0	0
51	219.577	30.7044	0	0	0

Query 1 (bishop simplified) - Safety Factor: 3.11046

Slice Number	X coordinate [ft]	Y coordinate - Bottom [ft]	Interslice Normal Force [lbs]	Interslice Shear Force [lbs]	Interslice Force Angle [deg]
1	75.0955	2.3719	0	0	0
2	77.9402	2.62211	91.5096	0	0
3	80.7848	2.88431	182.822	0	0
4	83.6294	3.15852	273.096	0	0
5	86.474	3.44475	361.541	0	0
6	89.3187	3.74302	447.42	0	0
7	92.1633	4.05334	530.045	0	0
8	95.0079	4.37572	608.777	0	0
9	97.8526	4.7102	683.033	0	0
10	100.697	5.05677	752.276	0	0
11	103.542	5.41547	816.026	0	0
12	106.386	5.78631	873.849	0	0
13	109.231	6.16931	925.366	0	0
14	112.076	6.56449	970.249	0	0
15	114.92	6.97188	1008.22	0	0
16	117.765	7.39149	1039.06	0	0
17	120.61	7.82336	1062.59	0	0
18	123.454	8.26749	1078.7	0	0
19	126.299	8.72392	1087.32	0	0
20	129.144	9.19267	1088.43	0	0
21	131.988	9.67377	1082.08	0	0
22	134.833	10.1672	1068.36	0	0
23	137.677	10.6731	1047.41	0	0
24	140.522	11.1914	1019.45	0	0
25	143.367	11.7222	984.716	0	0
26	146.211	12.2654	943.531	0	0
27	150.544	13.1168	869.322	0	0
28	153.42	13.6982	812.956	0	0
29	156.296	14.2925	751.571	0	0
30	159.173	14.8996	685.75	0	0
31	162.049	15.5198	616.136	0	0
32	164.926	16.1529	543.434	0	0
33	167.802	16.799	468.407	0	0
34	170.678	17.4582	391.882	0	0
35	173.555	18.1305	314.744	0	0
36	176.431	18.8159	237.945	0	0
37	179.308	19.5146	162.496	0	0
38	182.184	20.2264	89.4726	0	0
39	185.06	20.9515	20.0155	0	0
40	187.937	21.6899	-44.6708	0	0
41	190.813	22.4417	-103.316	0	0
42	193.69	23.2068	-154.584	0	0
43	196.566	23.9855	-197.07	0	0
44	199.442	24.7776	-229.305	0	0
45	202.319	25.5832	-249.748	0	0
46	205.195	26.4025	-256.791	0	0
47	208.072	27.2353	-248.755	0	0
48	210.948	28.0819	-223.89	0	0
49	213.824	28.9423	-180.373	0	0
50	216.701	29.8164	-116.311	0	0
51	219.577	30.7044	0	0	0

◆ Simplified Janbu Method - Total Stress

Global Minimum Query (bishop simplified) - Safety Factor: 3.11046

Slice Number	X coordinate [ft]	Y coordinate - Bottom [ft]	Interslice Normal Force [lbs]	Interslice Shear Force [lbs]	Interslice Force Angle [deg]
1	75.0955	2.3719	0	0	0
2	77.9402	2.62211	91.5096	0	0
3	80.7848	2.88431	182.822	0	0
4	83.6294	3.15852	273.096	0	0
5	86.474	3.44475	361.541	0	0
6	89.3187	3.74302	447.42	0	0
7	92.1633	4.05334	530.045	0	0
8	95.0079	4.37572	608.777	0	0
9	97.8526	4.7102	683.033	0	0
10	100.697	5.05677	752.276	0	0
11	103.542	5.41547	816.026	0	0
12	106.386	5.78631	873.849	0	0
13	109.231	6.16931	925.366	0	0
14	112.076	6.56449	970.249	0	0
15	114.92	6.97188	1008.22	0	0
16	117.765	7.39149	1039.06	0	0
17	120.61	7.82336	1062.59	0	0
18	123.454	8.26749	1078.7	0	0
19	126.299	8.72392	1087.32	0	0
20	129.144	9.19267	1088.43	0	0
21	131.988	9.67377	1082.08	0	0
22	134.833	10.1672	1068.36	0	0
23	137.677	10.6731	1047.41	0	0
24	140.522	11.1914	1019.45	0	0
25	143.367	11.7222	984.716	0	0
26	146.211	12.2654	943.531	0	0
27	150.544	13.1168	869.322	0	0
28	153.42	13.6982	812.956	0	0
29	156.296	14.2925	751.571	0	0
30	159.173	14.8996	685.75	0	0
31	162.049	15.5198	616.136	0	0
32	164.926	16.1529	543.434	0	0
33	167.802	16.799	468.407	0	0
34	170.678	17.4582	391.882	0	0
35	173.555	18.1305	314.744	0	0
36	176.431	18.8159	237.945	0	0
37	179.308	19.5146	162.496	0	0
38	182.184	20.2264	89.4726	0	0
39	185.06	20.9515	20.0155	0	0
40	187.937	21.6899	-44.6708	0	0
41	190.813	22.4417	-103.316	0	0
42	193.69	23.2068	-154.584	0	0
43	196.566	23.9855	-197.07	0	0
44	199.442	24.7776	-229.305	0	0
45	202.319	25.5832	-249.748	0	0
46	205.195	26.4025	-256.791	0	0
47	208.072	27.2353	-248.755	0	0
48	210.948	28.0819	-223.89	0	0
49	213.824	28.9423	-180.373	0	0
50	216.701	29.8164	-116.311	0	0
51	219.577	30.7044	0	0	0

Query 1 (bishop simplified) - Safety Factor: 3.11046

Slice Number	X coordinate [ft]	Y coordinate - Bottom [ft]	Interslice Normal Force [lbs]	Interslice Shear Force [lbs]	Interslice Force Angle [deg]
1	75.0955	2.3719	0	0	0
2	77.9402	2.62211	91.5096	0	0
3	80.7848	2.88431	182.822	0	0
4	83.6294	3.15852	273.096	0	0
5	86.474	3.44475	361.541	0	0
6	89.3187	3.74302	447.42	0	0
7	92.1633	4.05334	530.045	0	0
8	95.0079	4.37572	608.777	0	0
9	97.8526	4.7102	683.033	0	0
10	100.697	5.05677	752.276	0	0
11	103.542	5.41547	816.026	0	0
12	106.386	5.78631	873.849	0	0
13	109.231	6.16931	925.366	0	0
14	112.076	6.56449	970.249	0	0
15	114.92	6.97188	1008.22	0	0
16	117.765	7.39149	1039.06	0	0
17	120.61	7.82336	1062.59	0	0
18	123.454	8.26749	1078.7	0	0
19	126.299	8.72392	1087.32	0	0
20	129.144	9.19267	1088.43	0	0
21	131.988	9.67377	1082.08	0	0
22	134.833	10.1672	1068.36	0	0
23	137.677	10.6731	1047.41	0	0
24	140.522	11.1914	1019.45	0	0
25	143.367	11.7222	984.716	0	0
26	146.211	12.2654	943.531	0	0
27	150.544	13.1168	869.322	0	0
28	153.42	13.6982	812.956	0	0
29	156.296	14.2925	751.571	0	0
30	159.173	14.8996	685.75	0	0
31	162.049	15.5198	616.136	0	0
32	164.926	16.1529	543.434	0	0
33	167.802	16.799	468.407	0	0
34	170.678	17.4582	391.882	0	0
35	173.555	18.1305	314.744	0	0
36	176.431	18.8159	237.945	0	0
37	179.308	19.5146	162.496	0	0
38	182.184	20.2264	89.4726	0	0
39	185.06	20.9515	20.0155	0	0
40	187.937	21.6899	-44.6708	0	0
41	190.813	22.4417	-103.316	0	0
42	193.69	23.2068	-154.584	0	0
43	196.566	23.9855	-197.07	0	0
44	199.442	24.7776	-229.305	0	0
45	202.319	25.5832	-249.748	0	0
46	205.195	26.4025	-256.791	0	0
47	208.072	27.2353	-248.755	0	0
48	210.948	28.0819	-223.89	0	0
49	213.824	28.9423	-180.373	0	0
50	216.701	29.8164	-116.311	0	0
51	219.577	30.7044	0	0	0

Discharge Sections

Entity Information

◆ Simplified Bishop Method - Total Stress

Shared Entities

Type	Coordinates (x,y)
External Boundary	0, 0
	0, -11
	0, -150
	532.8, -150
	532.8, -30.9
	532.8, -27.9
	532.8, 49.2
	532.8, 53.2
	528.8, 53.2
	268, 40.2
63, 0	
Material Boundary	63, 0
	72.5, 0
	148, -30.9
	532.8, -27.9
Material Boundary	63, 0
	90.5811, -11
	148, -33.9
	532.8, -30.9
Material Boundary	72.5, 0
	83.8, 0
	268, 36.2
	528, 49.2
	532.8, 49.2
Material Boundary	0, -11
	90.5811, -11

◆ Simplified Janbu Method - Total Stress

Shared Entities

Type	Coordinates (x,y)
External Boundary	0, 0 0, -11 0, -150 532.8, -150 532.8, -30.9 532.8, -27.9 532.8, 49.2 532.8, 53.2 528.8, 53.2 268, 40.2 63, 0
Material Boundary	63, 0 72.5, 0 148, -30.9 532.8, -27.9
Material Boundary	63, 0 90.5811, -11 148, -33.9 532.8, -30.9
Material Boundary	72.5, 0 83.8, 0 268, 36.2 528, 49.2 532.8, 49.2
Material Boundary	0, -11 90.5811, -11

Refer to the clean copy for the Slide2 Output pages for the overliner section.

**INFINITE SLOPE
STABILITY ANALYSIS**

STABILITY ANALYSIS OF THE LINER/OVERLINER/FINAL COVER SYSTEMS

Client: City of Del Rio

Date: 3/7/2025

Project: Major Permit Amendment

Job No: DELR2000302

Description: Final Cover Settlement Analysis

By: T. Metaferia

Checked By: B. Hindman

Purpose - Evaluate the stability of the liner/overliner/final cover system components.

References:

- 1 Koerner, Robert M., Designing with Geosynthetics, 3rd Edition, Prentice-Hall Inc., 1994.
- 2 Duncan, J.M. and Buchignani, A. L., An Engineering Manual for Slope Stability Studies,
Department of Civil Engineering - University of California-Berkeley, 1975.
- 3 USACE, Slope Stability, Engineering and Design Manual, EM 1110-2-1902, October 31,
2003.
- 4 Koerner, Robert M., Analysis and Design of Veneer Cover Soils, 1998 Sixth International
Conference of Geosynthetics.
- 5 Koerner, George R. and Narejo, Dhani, Direct Shear Database of Geosynthetic-to-
Geosynthetic and Geosynthetic-to-Soil Interfaces, GRI Report #30, June 14, 2005.
- 6 Gilbert, Robert B., Peak Versus Residual Strength for Waste Containment Systems,
Proceedings of the 15th GRI Conference, December 13, 2001.
- 7 NAVFAC Design Manual 7.01, September 1986.

STABILITY ANALYSIS OF THE LINER/OVERLINER/FINAL COVER SYSTEMS

Client: City of Del Rio
Project: Major Permit Amendment
Description: Liner System Stability
 Infinite Slope - Stability Analysis

Date: 3/7/2025
Job No: DELR2000302
By: T. Metaferia
Checked By: B. Hindman

Purpose - Evaluate the stability of the liner/overliner/final cover system components.

A. Liner System Stability - Anchor Trench Design

The liner system includes a 2-foot-thick protective cover, drainage geocomposite, and a 2-foot-thick compacted clay liner (CCL).

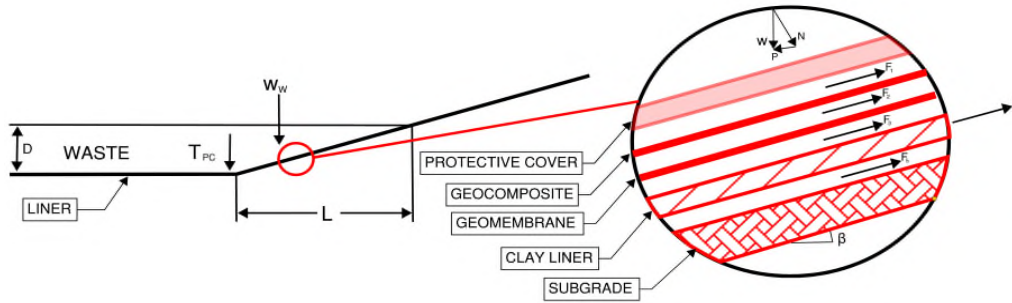

1. Verify that tensile stress in liner system is less than yield stress for the liner system.

Clay Liner

Definition of terms/variables:

$$W_E = \text{Weight of equipment, lb/ft}$$

Assume a Caterpillar D8T WH Track-Type Tractor

- Operational Weight = 85,150 lb
- Number of Tracks = 2
- Track Width = 1.84 ft
- W_w = Weight of solid waste, lb/ft
- W_{pc} = Weight of protective cover, lb/ft
- W_T = Combined weight of equipment, solid waste, and protective cover, lb/ft
- T_{pc} = Friction force on edge of protective cover, lb/ft
- W = Net force of equipment, waste, and protective cover on liner system, lb/ft
- N = Normal force on liner system, lb/ft
- P = Shearing force on liner system, lb/ft
- β = Slope angle, degree
- F_N = Resisting force, lb/ft

$$F_N = (N (\tan \Delta_n)) + \frac{C_{an} L}{\cos \beta}$$

- F_1 = Resistance of protective cover/geocomposite interface, lb/ft
- F_2 = Resistance of geocomposite/textured geomembrane interface, lb/ft
- F_3 = Resistance of textured geomembrane/geosynthetic clay liner interface, lb/ft
- F_4 = Resistance of internal geosynthetic clay liner, lb/ft
- F_5 = Resistance of geosynthetic clay liner/foundation layer interface, lb/ft
- F_6 = Resistance of textured geocomposite/clay liner interface, lb/ft
- F_7 = Resistance of internal clay liner, lb/ft
- F_8 = Resistance of clay liner/subgrade interface, lb/ft
- Δ_n = Interface friction angle of interface "n", degree
- C_{an} = Adhesion of interface "n", psf
- ϕ_n = Internal friction angle of material "n", degree
- C_n = Cohesion of material "n", psf
- γ_{was} = Unit weight of solid waste (including daily cover), pcf
- D_{was} = Individual lift height, ft
- ϕ_{was} = Internal friction angle of waste, degree
- γ_{pc} = Unit weight of protective cover, pcf
- D_{pc} = Thickness of protective cover, ft
- ϕ_{pc} = Internal friction angle of protective cover, degree
- L = Horizontal length of lift, ft

Parameters:

- | | |
|------------------------------------|-------------------------|
| $\beta_{sideslope}$ = 14.04 degree | Δ_7 = 18 degree |
| Δ_1 = 16 degree | C_{a7} = 200 psf |
| C_{a1} = 100 psf | Δ_8 = 16 degree |
| Δ_2 = 16 degree | C_{a8} = 100 psf |
| C_{a2} = 100 psf | γ_{was} = 59 pcf |
| Δ_3 = 16 degree | D_{was} = 10 ft |
| C_{a3} = 100 psf | ϕ_{was} = 21 deg |
| ϕ_4 = 16 degree | γ_{pc} = 120 pcf |
| C_{a4} = 100 psf | D_{pc} = 2 ft |
| Δ_5 = 16 degree | ϕ_{pc} = 16 deg |
| C_{a5} = 100 psf | L = 30 ft |
| ϕ_6 = 16 degree | |
| C_{a6} = 100 psf | |

Interface friction strength values are selected conservatively from laboratory testing of similar material/interfaces. Prior to construction, laboratory tests will be performed to verify the assumed values for interface adhesion (or cohesion) and friction angle using project-specific soil and synthetic materials. The interface friction testing will be performed for the specific conditions analyzed. If test results differ from the assumed values, this analysis will be updated for acceptable factor of safety values using the procedure presented in the following sections.

Weight of Equipment

$$W_E = \frac{\text{Operational Weight}}{\text{Number of tracks} \times \text{Width of track}}$$

$$W_E = 23,139 \text{ lb/ft}$$

Weight of Solid Waste

$$W_W = \frac{D_{was} L \gamma_{was}}{2}$$

$$W_W = 8,850 \text{ lb/ft}$$

Weight of Protective Cover

$$W_{PC} = D_{pc} \gamma_{pc} \frac{L}{\cos \beta_{sideslope}}$$

$$W_{PC} = 7,422 \text{ lb/ft}$$

Combined Weight of Equipment, Solid Waste, and Protective Cover

$$W_T = W_E + W_W + W_{PC}$$

$$W_T = 39,410 \text{ lb/ft}$$

Friction Force on Edge of Protective Cover

$$T_{PC} = k_o \sigma_v (\tan \phi_{pc}) D_{pc}$$

$$\text{Where: } k_o = 1 - \sin \phi_{pc}$$

$$\sigma_v = \frac{D_{pc} \gamma_{pc}}{2}$$

$$T_{PC} = 50 \text{ lb/ft}$$

Net Force of Equipment, Solid Waste, and Protective Cover on Liner System

$$W = W_T - T_{PC}$$

$$W = 39,360 \text{ lb/ft}$$

$$N = W (\cos \beta_{sideslope})$$

$$N = 38,185 \text{ lb/ft}$$

$$P_{sideslope} = W (\sin \beta_{sideslope})$$

$$P_{sideslope} = 9,549 \text{ lb/ft}$$

Compacted Clay Liner Option (Subtitle D Cells)

$$\text{Resistance of protective cover/geocomposite interface, lb/ft} \quad F_1 = 14,042 \text{ lb/ft}$$

$P_{\text{sideslope}} < F_1$ Therefore, protective cover soil is stable on the geocomposite and a driving force equal to P is transferred to the next interface.

$$\text{Resistance of geocomposite/textured geomembrane interface, lb/ft} \quad F_2 = 14,042 \text{ lb/ft}$$

$P_{\text{sideslope}} < F_2$ Therefore, geocomposite is stable on the geomembrane and a driving force equal to P is transferred to the next interface.

$$\text{Resistance of textured geocomposite/clay liner interface, lb/ft} \quad F_6 = 14,042 \text{ lb/ft}$$

$P_{\text{sideslope}} < F_7$ Therefore, the geocomposite is stable on the clay liner and a driving force equal to P is transferred to the next interface.

$$\text{Resistance of internal clay liner, lb/ft} \quad F_7 = 18,592 \text{ lb/ft}$$

$P_{\text{sideslope}} < F_8$ Therefore, the clay liner internally is stable and a driving force equal to P is transferred to the next interface.

$$\text{Resistance of clay liner/subgrade interface, lb/ft} \quad F_8 = 14,042 \text{ lb/ft}$$

$P_{\text{sideslope}} < F_6$ Therefore, the clay liner is stable on the subgrade and a driving force equal to P is transferred to the next interface.

$$\text{The Actual Tensile Force on liner system} \quad T_{\text{act}} = 0$$

Geosynthetic Clay Liner Option (Overliner)

$$\text{Resistance of protective cover/geocomposite interface, lb/ft} \quad F_1 = 14,042$$

$P_{\text{sideslope}} < F_1$ Therefore, protective cover soil is stable on the geocomposite and a driving force equal to P is transferred to the next interface.

$$\text{Resistance of geocomposite/textured geomembrane interface, lb/ft} \quad F_2 = 14,042$$

$P_{\text{sideslope}} < F_2$ Therefore, geocomposite is stable on the geomembrane and a driving force equal to P is transferred to the next interface.

$$\text{Resistance of textured geomembrane/geosynthetic clay liner interface} \quad F_3 = 14,042$$

$P_{\text{sideslope}} < F_3$ Therefore, geomembrane is stable on the geosynthetic clay liner and a driving force equal to P is transferred to the next interface.

$$\text{Resistance of internal geosynthetic clay liner, lb/ft} \quad F_4 = 14,042$$

$P_{\text{sideslope}} < F_4$ Therefore, the geosynthetic clay liner internally is stable and a driving force equal to P is transferred to the next interface.

$$\text{Resistance of geosynthetic clay liner/foundation layer interface, lb/ft} \quad F_5 = 14,042$$

$P_{\text{sideslope}} < F_5$ Therefore, the clay liner is stable on the geocomposite and a driving force equal to P is transferred to the next interface.

$$\text{The Actual Tensile Force on liner system, lb/ft} \quad T_{\text{act}} = 0$$

2. Verify that tensile stress in liner system is less than yield stress for the liner system.

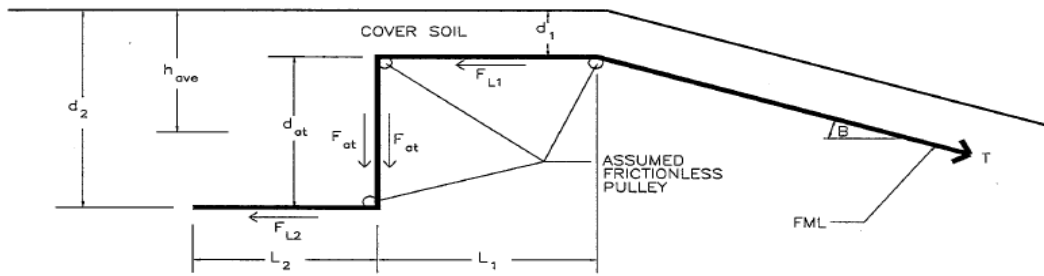

$$T = F_{L1} + F_{L2} + F_{at}$$

Where:

T = Tensile Force necessary for pullout, lb/ft

$$F_{L1} = (q_1 \tan \Delta) L_1$$

q_1 = $d_1 \times \gamma_{soil}$ Surcharge Pressure, psf

d_1 = Depth of soil, ft

γ_{soil} = Unit weight of soil, pcf

Δ = Interface friction angle, degrees

L_1 = Length of runout, ft

$$F_{L2} = (q_2 \tan \Delta) L_2$$

q_2 = $d_2 \times \gamma_{soil}$ Surcharge Pressure, psf

d_2 = Depth of soil, ft

γ_{soil} = Unit weight of soil, pcf

Δ = Interface friction angle, degrees

L_2 = Length of runout, ft

$$F_{at} = (V \tan \Delta) d_{at}$$

V = $K_o \times y$ Average horizontal stress, psf

K_o = $1 - \sin(r)$

r = Internal friction angle of soil, degrees

y = $\gamma_{soil} \times h_{ave}$

h_{ave} = Average depth of trench, ft

γ_{soil} = Unit weight of soil, pcf

Δ = Interface friction angle, degrees

d_{at} = Depth of trench, ft

Parameters:

γ_{soil}	=	120	pcf
Δ	=	15	degree
r	=	16	degree
d_1	=	2.0	ft
L_1	=	6.0	ft
d_2	=	4.0	ft
L_2	=	2.0	ft
d_{at}	=	2.0	ft
h_{ave}	=	3.0	ft
F_{L1}	=	385.8	lb/ft
F_{L2}	=	257.2	lb/ft
F_{at}	=	139.7	lb/ft
T	=	782.8	lb/ft

Compare force required for pullout (T) with the actual tensile force in the geomembrane from Part 1:

T	=	783	lb/ft
T_{ac}	=	0	lb/ft

$$T > T_{\text{ac}}$$

Therefore, the runout lengths are sufficient to prevent pullout.

B. Infinite Slope Stability Analysis

Interface friction strength values are selected conservatively from laboratory testing of similar material/interfaces. Prior to construction, laboratory tests will be performed to verify the assumed values for interface adhesion (or cohesion) and friction angle using project-specific soil and synthetic materials. The interface friction testing will be performed for the specific conditions analyzed. If test results differ from the assumed values, this analysis will be updated for acceptable factor of safety values using the procedure presented in the following sections.

The liner, overliner, and final cover systems are described below.

Liner System

The liner system includes a 2-foot-thick protective cover, drainage geocomposite, and a 2-foot-thick compacted clay liner (CCL).

Overliner System

The overliner system includes a 2-foot-thick protective cover, drainage geocomposite, geomembrane, GCL, and prepared subgrade.

Final Cover System

The final cover system includes a 1-foot-thick erosion layer and an 18-inch-thick clay infiltration layer.

1. Use Duncan and Buchignani's method for infinite stability analyses to evaluate the internal stability of the liner, overliner, and final cover systems using peak and residual shear strength values.

The factor of safety is calculated using the following equation:

$$F.S. = A \frac{\tan \Delta}{\tan \beta} + B \frac{C_a}{\gamma H}$$

Where:

Δ	=	Interface friction angle, degrees
β	=	Slope angle, degrees
A	=	Parameter A from chart on page IILL-B-222
B	=	Parameter B from chart on page IILL-B-222
C_a	=	Adhesion, psf
γ	=	Unit weight of soil, pcf
H	=	Thickness of material above interface, ft

An example using the protective cover/geocomposite interface of the liner system is provided below.

A. Define the shear strength parameters (peak shear strength parameters will be used for this example).

Δ	=	18	degree
C_a	=	100	psf

B. Calculate the pore pressure (r_u) using the following equation:

$$r_u = \frac{T \gamma_w \cos^2 \beta}{H \gamma}$$

Where:

H	=	Thickness of material above interface, ft
β	=	Slope angle, degrees
γ_w	=	Unit weight of water, pcf
T	=	Maximum head above interface, ft
γ	=	Unit weight of soil, pcf
b	=	$\cot(\beta)$ Slope ratio

Parameters:

H	=	2	feet
β	=	18.43	degree (3H:1V)
γ_w	=	62.4	pcf
T	=	0	ft
γ	=	120	pcf
b	=	3.0	

$$r_u = 0.0$$

Since T=0, there is no pore pressure build-up in the protective cover. If the soil material is assumed to be saturated, use a unit weight of 125 pcf for soil.

C. Using r_u and b, determine Parameters A and B from the charts on page IILL-B-222.

A	=	1.0
B	=	3.3

D. Calculate the factor of safety and compare against the minimum recommended factor of safety.

F.S.	=	2.35
F.S. _{min}	=	1.5
F.S.	>	F.S. _{min}

Infinite Slope Stability Analysis Summary

Landfill Component/ Interface	Strength Parameters				H (ft)	γ (pcf)	β (degree)	T (ft)	r _u	b	A	B	Factor of Safety Generated		Recommended Minimum Factor of Safety		Acceptable Factor of Safety			
	Cohesion/Adhesion (psf)		Friction Angle (degrees)										Peak	Residual	Peak	Residual	Peak	Residual	Peak	Residual
	Peak	Residual	Peak	Residual																
Liner System (3H:1V Slope)																				
Clay Liner																				
Protective Cover/ Geocomposite	100	80	18	14	2	120	18.43	0.0	0.0	3.0	1.0	3.3	2.35	1.85	1.5	1.0	Yes	Yes		
Geocomposite/ Clay Liner	100	80	15	10	2	120	18.43	0.0	0.0	3.0	1.0	3.3	2.18	1.63	1.5	1.0	Yes	Yes		
Clay Liner Internal	100	-	16	-	2	120	18.43	0.0	0.0	3.0	1.0	3.3	2.24	-	1.5	-	Yes	-		
Overliner System (25 Percent Maximum Slope)																				
Protective Cover/ Geocomposite	100	80	18	14	2	120	11.31	0.0	0.0	5.0	1.0	5.3	3.83	3.01	1.5	1.0	Yes	Yes		
Textured Geomembrane	100	80	21	10	2	120	11.31	0.0	0.0	5.0	1.0	5.3	4.13	2.65	1.5	1.0	Yes	Yes		
Geomembrane/ Geosynthetic Clay	100	80	18	10	2	120	11.31	0.0	0.0	5.0	1.0	5.3	3.83	2.65	1.5	1.0	Yes	Yes		
Geosynthetic Clay Liner Internal	100	80	24	-	2	120	11.31	0.0	0.0	5.0	1.0	5.3	4.43	-	1.5	1.0	Yes	Yes		
Geosynthetic Clay Liner/ Subgrade	100	80	25	12	2	120	11.31	0.0	0.0	5.0	1.0	5.3	4.54	2.83	1.5	1.0	Yes	Yes		

Landfill Component/ Interface	Strength Parameters				H (ft)	γ (pcf)	β (degree)	T (ft)	r _u	b	A	B	Factor of Safety Generated		Recommended Minimum Factor of Safety		Acceptable Factor of Safety			
	Cohesion/Adhesion (psf)		Friction Angle (degrees)										Peak	Residual	Peak	Residual	Peak	Residual	Peak	Residual
	Peak	Residual	Peak	Residual																
Final Cover System (25 Percent Sideslope)																				
Composite Final Cover (Saturated Erosion Layer)																				
Erosion Layer/ Clay Infiltration Liner	100	80	18	14	1	116	14.04	0.0	0.00	4.0	1.00	4.3	5.01	3.96	1.5	1.0	Yes	Yes		
Clay Infiltration Liner Internal	100	-	16	-	1	116	14.04	0.0	0.00	4.0	1.00	4.3	4.85	-	1.5	-	-	-		
Final Cover System (5 Percent Top Slope)																				
Composite Final Cover (Saturated Erosion Layer)																				
Erosion Layer/ Clay Infiltration Liner	100	80	18	14	1	116	3.43	0.0	0.00	16.7	1.00	6.3	10.85	8.50	1.5	1.0	Yes	Yes		
Clay Infiltration Liner Internal	100	-	16	-	1	116	3.43	0.0	0.00	16.7	1.00	6.3	10.22	-	1.5	-	-	-		

EM 1110-2-1902
31 Oct 03

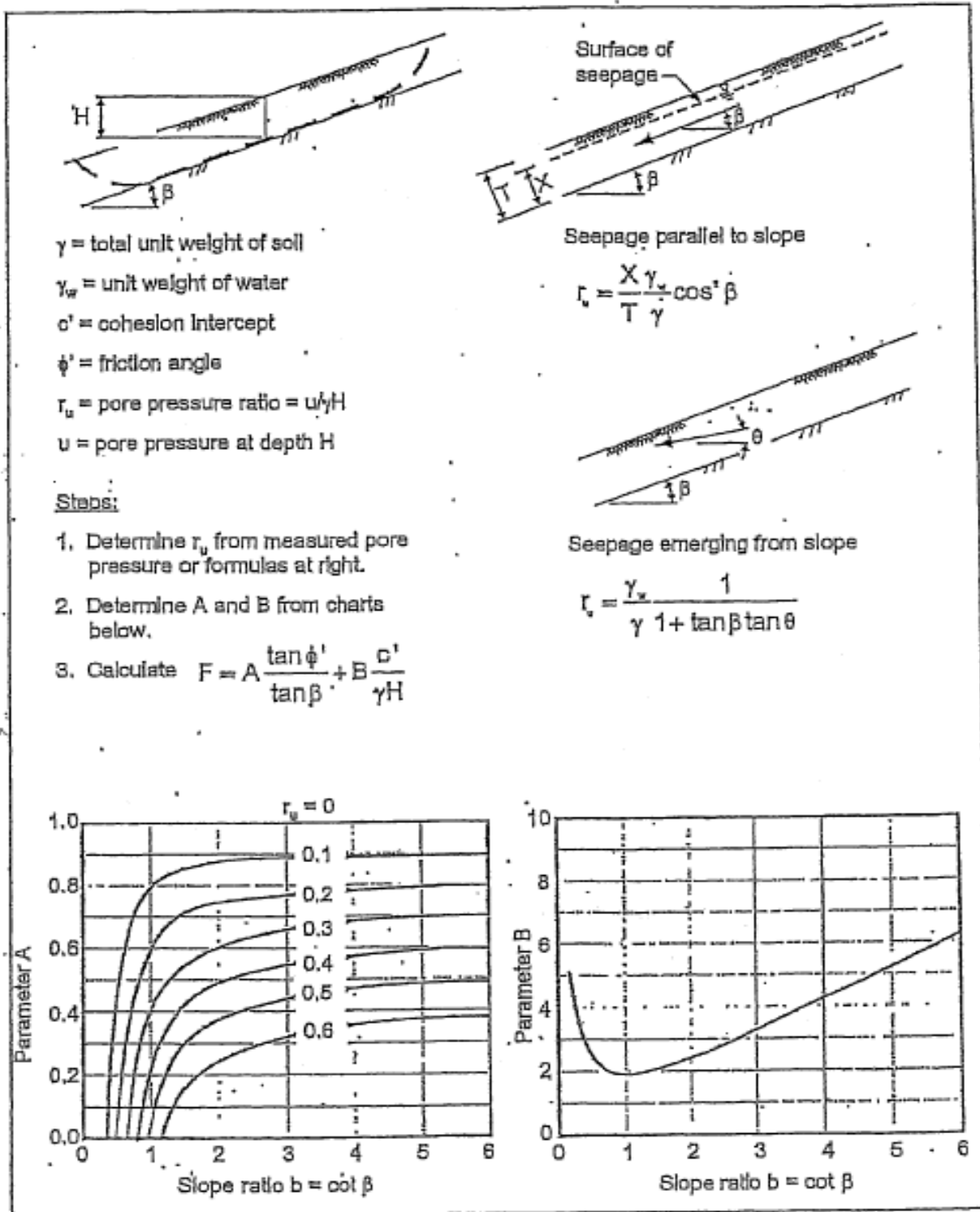

Figure E-7. Slope stability charts for infinite slopes (after Duncan, Buchanan, and DeWet 1987)

**CITY OF DEL RIO LANDFILL
VAL VERDE COUNTY, TEXAS
TCEQ PERMIT NO. MSW-207C**

**MAJOR PERMIT AMENDMENT APPLICATION
PART III – SITE DEVELOPMENT**

**APPENDIX IIII-B
SETTLEMENT AND HEAVE ANALYSIS**

Prepared for
City of Del Rio

September 2023
[Revision 1 August 2024](#)



Prepared by
CP&Y Inc
TPBE Registration No. F-1741
1820 Regal Row, Suite 200
Dallas, TX 75235
214-638-0500

This document is intended for permitting purposes only.

TABLE OF CONTENTS

1.0 INTRODUCTION IIII-B-iii

LIST OF FIGURES

Figure IIII-B-88 – Foundation Settlement Evaluation Points IIII-B-2
Figure IIII-B-89 – Final Cover Settlement Evaluation Points..... IIII-B-18



1.0 INTRODUCTION

This appendix includes the settlement, strain and heave analyses for the foundation soils and the settlement and strain analyses for the final cover system.

**FOUNDATION SETTLEMENT AND
HEAVE ANALYSIS**

Foundation Settlement and Heave Analysis

Client: City of Del Rio	Date: 3/7/2025
Project: Major Permit Amendment	Job No: DELR2000302
Description: Foundation Settlement and Heave Analysis	By: T. Metaferia
	Checked By: B. Hindman

Purpose - Estimate the settlement of landfill subgrade.
 Estimate the amount of heave or uplift resulting from excavations for liner construction.
 Calculate the post-settlement strain in the leachate collection system and liner.

Step 1 - Select critical location for settlement.

Waste filling and liner and final cover installation will result in loading of the foundation soils, causing consolidation. The magnitude of consolidation will be a function of the net stress increase and properties of the foundation soils. Net stress increase is assumed to be the addition of the load to the excavation grades.

The evaluation points were chosen at specific locations to analyze the post-settlement slopes of the leachate collection system and liner system. Evaluation point locations are shown on Sheet IIII-B-2.

LEGEND

- GP-5 PROPOSED GAS PROBE
- UV-1 PROPOSED GAS VENTS
- CUT/FILL MARKERS
- SETTLEMENT EVALUATION POINT
- PROPOSED PERMIT BOUNDARY
- PROPOSED LIMIT OF WASTE
- CELL BOUNDARY
- EXISTING GRADES
- PROPOSED EXCAVATION GRADES
- PERMITTED EXCAVATION GRADES
- PERMITTED OVERLINER GRADES
- CELL DESIGNATION
- PROPOSED LEACHATE COLLECTION RISER
- PROPOSED LEACHATE COLLECTION CLEANOUT
- PROPOSED LEACHATE COLLECTION SUMP
- PROPOSED LEACHATE COLLECTION LINE

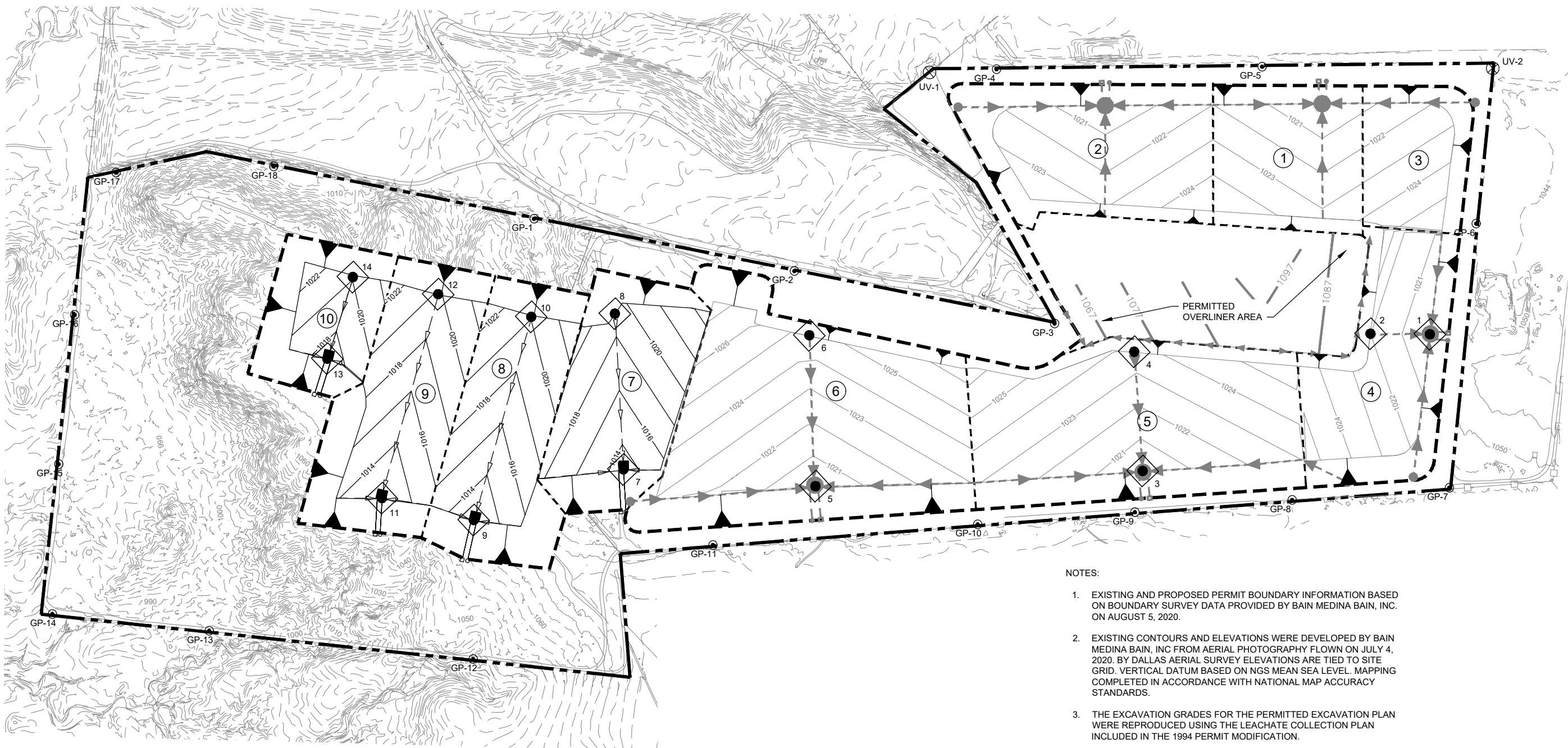
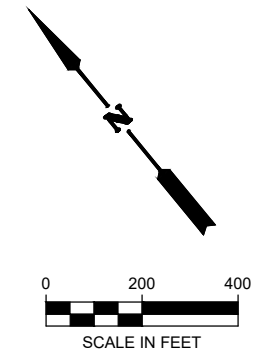

- NOTES:**
- EXISTING AND PROPOSED PERMIT BOUNDARY INFORMATION BASED ON BOUNDARY SURVEY DATA PROVIDED BY BAIN MEDINA BAIN, INC. ON AUGUST 5, 2020.
 - EXISTING CONTOURS AND ELEVATIONS WERE DEVELOPED BY BAIN MEDINA BAIN, INC FROM AERIAL PHOTOGRAPHY FLOWN ON JULY 4, 2020. BY DALLAS AERIAL SURVEY ELEVATIONS ARE TIED TO SITE GRID. VERTICAL DATUM BASED ON NGS MEAN SEA LEVEL. MAPPING COMPLETED IN ACCORDANCE WITH NATIONAL MAP ACCURACY STANDARDS.
 - THE EXCAVATION GRADES FOR THE PERMITTED EXCAVATION PLAN WERE REPRODUCED USING THE LEACHATE COLLECTION PLAN INCLUDED IN THE 1994 PERMIT MODIFICATION.
 - EXCAVATION SLOPES ARE TYPICALLY 3H:1V.
 - MINIMUM EXCAVATION ELEVATION AT LEACHATE COLLECTION SYSTEM SUMP IS 1007 FT-MSL.
 - LINER AND LEACHATE COLLECTION SYSTEM DETAILS ARE INCLUDED IN APPENDIX IIIA-A.

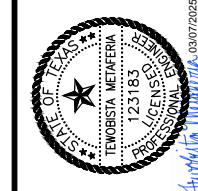

NO.	2nd TECHNICAL NOD	REVISION	BY	DATE
1.			STV	03/2025

VERIFY SCALE BAR LENGTH EQUALS ONE INCH ON ORIGINAL DRAWING. VERIFY LENGTH ON THIS SHEET 0" AND ADJUST SCALE ACCORDINGLY.

CITY OF DEL RIO LADEILL NO. 207C
 MAJOR PERMIT AMENDMENT

FOUNDATION SETTLEMENT
 EVALUATION POINTS

DESIGN: T. METAFERIA
 DRAWN: T. METAFERIA
 REVIEW: B. HINDMAN
 CP&Y: DELR200302
 CLIENT: CITY OF DEL RIO

FIGURE
 1 IIL-B-2

PRINTED BY: Metaferia
 FILE PATH: C:\pwworking\stvm\metaferia\0942279\DEL200302\Figure IIL-B-2.dwg

Foundation Settlement

Client: City of Del Rio
Project: Major Permit Amendment
Description: Foundation Settlement and Heave Analysis

Date: 3/7/2025
Job No: DELR2000302
By: T. Metaferia
Checked By: B. Hindman

Step 2 - Estimate the settlement of the landfill subgrade at critical locations:

The following equation was used to calculate the effective overburden stress for each n, number of layers in the landfill system components (i.e., liner system, waste etc.). There was no groundwater encountered at the site, therefore unsaturated and the moist unit weight is used.

$$p_{o(n)} = 0.5H_{o(n)}\gamma_n + \sum_{i=1}^{i=n-1} (H_{o(i)}\gamma_i)$$

The following equation was used to calculate the increase in overburden stress due to the development of the landfill using moist unit weights for the liner, protective cover, waste, and final cover:

$$\Delta P = H_{liner}\gamma_{liner} + H_{pc}\gamma_{pc} + H_{waste}\gamma_{waste} + H_{fc}\gamma_{fc}$$

The following equations were used to calculate the settlement:

$$\text{If } p_o + \Delta p < p_c: \quad S = \frac{C_o H_o}{1 + e_o} \log\left(\frac{p_o + \Delta p}{p_c}\right) + \frac{C_r H_o}{1 + e_o} \log\left(\frac{p_c}{p_o}\right)$$

$$\text{If } p_o + \Delta p > p_c: \quad S = \frac{C_r H_o}{1 + e_o} \log\left(\frac{p_o + \Delta p}{p_c}\right)$$

The following equation was used to calculate the final height of each layer after settlement:

$$H_f = H_o - S$$

Where:

H_o = Initial thickness of sublayer, ft
 γ_d = Dry unit weight, pcf
 γ_m = Moist unit weight, pcf
 γ_{sat} = Saturated unit weight, pcf
 γ_w = Unit weight of water, pcf
 γ_{waste} = Unit weight of waste, pcf
 e_o = In-situ void ratio
 p_o = Initial average effective overburden pressure, psf
 Δp = Increase in vertical pressure, psf
 p_c = Preconsolidation Pressure, psf
 S = Settlement, ft
 C_c = Compression Index
 C_r = Recompression Index
 H_f = Final Thickness of Sublayer, ft
 pc = Protective Cover
 $liner$ = Liner
 $waste$ = Waste
 n = Number of Layers including Landfill System Components
 fc = Final Cover

Foundation Settlement

Client: City of Del Rio
Project: Major Permit Amendment
Description: Foundation Settlement and Heave Analysis

Date: 3/7/2025
Job No: DELR2000302
By: T. Metaferia
Checked By: B. Hindman

Increase in overburden stress due to development of landfill.

Note: Weights of materials above the evaluated strata are assumed to have moist units weights for the purpose of calculating the overburden pressure generated by these layers to estimate Δp . The unit weight of waste was based on the average waste thickness using the Unit Weight Profile for Waste/Daily Cover within an MSW Landfill chart from Ref 5.

At Evaluation Point 1:

Top of Final Cover Elevation (ft-msl) = 1063	Waste Thickness = 37.5 ft
Top of Protective Cover Elevation (ft-msl) = 1022.0	Protective Cover Thickness = 2.0 ft
Top of Waste Elevation (ft-msl) = 1059.5	Liner Thickness = 2.0 ft
Top of Liner Elevation (ft-msl) = 1020.0	Final Cover Thickness = 3.5 ft
$\gamma_{waste} = 47$ pcf	$\rho_{waste} = 1764.9$ psf
$\gamma_{pc} = 120$ pcf	$\rho_{pc} = 240.0$ psf
$\gamma_{liner} = 120$ pcf	$\rho_{liner} = 240.0$ psf
$\gamma_{fc} = 116$ pcf	$\rho_{fc} = 406.0$ psf
	$\Delta p = 2650.9$ psf

At Evaluation Point 2:

Top of Final Cover Elevation (ft-msl) = 1104	Waste Thickness = 74.5 ft
Top of Protective Cover Elevation (ft-msl) = 1026.0	Protective Cover Thickness = 2.0 ft
Top of Waste Elevation (ft-msl) = 1100.5	Liner Thickness = 2.0 ft
Top of Liner Elevation (ft-msl) = 1024	Final Cover Thickness = 3.5 ft
$\gamma_{waste} = 52$ pcf	$\rho_{waste} = 3901.9$ psf
$\gamma_{pc} = 120$ pcf	$\rho_{pc} = 240.0$ psf
$\gamma_{liner} = 120$ pcf	$\rho_{liner} = 240.0$ psf
$\gamma_{fc} = 116$ pcf	$\rho_{fc} = 406.0$ psf
	$\Delta p = 4787.9$ psf

At Evaluation Point 3:

Top of Final Cover Elevation (ft-msl) = 1070	Waste Thickness = 44.5 ft
Top of Protective Cover Elevation (ft-msl) = 1022.0	Protective Cover Thickness = 2.0 ft
Top of Waste Elevation (ft-msl) = 1066.5	Liner Thickness = 2.0 ft
Top of Liner Elevation (ft-msl) = 1020	Final Cover Thickness = 3.5 ft
$\gamma_{waste} = 48$ pcf	$\rho_{waste} = 2139.1$ psf
$\gamma_{pc} = 120$ pcf	$\rho_{pc} = 240.0$ psf
$\gamma_{liner} = 120$ pcf	$\rho_{liner} = 240.0$ psf
$\gamma_{fc} = 116$ pcf	$\rho_{fc} = 406.0$ psf
	$\Delta p = 3025.1$ psf

Foundation Settlement

Client: City of Del Rio
Project: Major Permit Amendment
Description: Foundation Settlement and Heave Analysis

Date: 3/7/2025
Job No: DELR2000302
By: T. Metaferia
Checked By: B. Hindman

At Evaluation Point 4:

Top of Final Cover Elevation (ft-msl) = 1098	Waste Thickness = 66.5 ft
Top of Protective Cover Elevation (ft-msl) = 1028.0	Protective Cover Thickness = 2.0 ft
Top of Waste Elevation (ft-msl) = 1094.5	Liner Thickness = 2.0 ft
Top of Liner Elevation (ft-msl) = 1026	Final Cover Thickness = 3.5 ft
$Y_{waste} = 51$ pcf	$p_{waste} = 3406.6$ psf
$Y_{pc} = 120$ pcf	$p_{pc} = 240.0$ psf
$Y_{liner} = 120$ pcf	$p_{liner} = 240.0$ psf
$Y_{fc} = 116$ pcf	$p_{fc} = 406.0$ psf
	$\Delta p = 4292.6$ psf

At Evaluation Point 5:

Top of Final Cover Elevation (ft-msl) = 1082	Waste Thickness = 56.5 ft
Top of Protective Cover Elevation (ft-msl) = 1022.0	Protective Cover Thickness = 2.0 ft
Top of Waste Elevation (ft-msl) = 1078.5	Liner Thickness = 2.0 ft
Top of Liner Elevation (ft-msl) = 1020	Final Cover Thickness = 3.5 ft
$Y_{waste} = 50$ pcf	$p_{waste} = 2813.2$ psf
$Y_{pc} = 120$ pcf	$p_{pc} = 240.0$ psf
$Y_{liner} = 120$ pcf	$p_{liner} = 240.0$ psf
$Y_{fc} = 116$ pcf	$p_{fc} = 406.0$ psf
	$\Delta p = 3699.2$ psf

At Evaluation Point 6:

Top of Final Cover Elevation (ft-msl) = 1072	Waste Thickness = 39.5 ft
Top of Protective Cover Elevation (ft-msl) = 1029.0	Protective Cover Thickness = 2.0 ft
Top of Waste Elevation (ft-msl) = 1068.5	Liner Thickness = 2.0 ft
Top of Liner Elevation (ft-msl) = 1027	Final Cover Thickness = 3.5 ft
$Y_{waste} = 47$ pcf	$p_{waste} = 1870.4$ psf
$Y_{pc} = 120$ pcf	$p_{pc} = 240.0$ psf
$Y_{liner} = 120$ pcf	$p_{liner} = 240.0$ psf
$Y_{fc} = 116$ pcf	$p_{fc} = 406.0$ psf
	$\Delta p = 2756.4$ psf

At Evaluation Point 7:

Top of Final Cover Elevation (ft-msl) = 1099	Waste Thickness = 78.5 ft
Top of Protective Cover Elevation (ft-msl) = 1017.0	Protective Cover Thickness = 2.0 ft
Top of Waste Elevation (ft-msl) = 1095.5	Liner Thickness = 2.0 ft
Top of Liner Elevation (ft-msl) = 1015	Final Cover Thickness = 3.5 ft
$Y_{waste} = 53$ pcf	$p_{waste} = 4156.5$ psf
$Y_{pc} = 120$ pcf	$p_{pc} = 240.0$ psf
$Y_{liner} = 120$ pcf	$p_{liner} = 240.0$ psf
$Y_{fc} = 116$ pcf	$p_{fc} = 406.0$ psf
	$\Delta p = 5042.5$ psf

Foundation Settlement

Client: City of Del Rio
Project: Major Permit Amendment
Description: Foundation Settlement and Heave Analysis

Date: 3/7/2025
Job No: DELR2000302
By: T. Metaferia
Checked By: B. Hindman

At Evaluation Point 8:

Top of Final Cover Elevation (ft-msl) = 1089	Waste Thickness = 62.5	ft	
Top of Protective Cover Elevation (ft-msl) = 1023.0	Protective Cover Thickness = 2.0	ft	
Top of Waste Elevation (ft-msl) = 1085.5	Liner Thickness = 2.0	ft	
Top of Liner Elevation (ft-msl) = 1021	Final Cover Thickness = 3.5	ft	
$Y_{waste} = 51$	pcf	$p_{waste} = 3165.8$	psf
$Y_{pc} = 120$	pcf	$p_{pc} = 240.0$	psf
$Y_{liner} = 120$	pcf	$p_{liner} = 240.0$	psf
$Y_{fc} = 116$	pcf	$p_{fc} = 406.0$	psf
		$\Delta p = 4051.8$	psf

At Evaluation Point 9:

Top of Final Cover Elevation (ft-msl) = 1095	Waste Thickness = 75.5	ft	
Top of Protective Cover Elevation (ft-msl) = 1016.0	Protective Cover Thickness = 2.0	ft	
Top of Waste Elevation (ft-msl) = 1091.5	Liner Thickness = 2.0	ft	
Top of Liner Elevation (ft-msl) = 1014	Final Cover Thickness = 3.5	ft	
$Y_{waste} = 53$	pcf	$p_{waste} = 3965.1$	psf
$Y_{pc} = 120$	pcf	$p_{pc} = 240.0$	psf
$Y_{liner} = 120$	pcf	$p_{liner} = 240.0$	psf
$Y_{fc} = 116$	pcf	$p_{fc} = 406.0$	psf
		$\Delta p = 4851.1$	psf

At Evaluation Point 10:

Top of Final Cover Elevation (ft-msl) = 1090.0	Waste Thickness = 62.5	ft	
Top of Protective Cover Elevation (ft-msl) = 1024.0	Protective Cover Thickness = 2.0	ft	
Top of Waste Elevation (ft-msl) = 1086.5	Liner Thickness = 2.0	ft	
Top of Liner Elevation (ft-msl) = 1022	Final Cover Thickness = 3.5	ft	
$Y_{waste} = 51$	pcf	$p_{waste} = 3165.8$	psf
$Y_{pc} = 120$	pcf	$p_{pc} = 240.0$	psf
$Y_{liner} = 120$	pcf	$p_{liner} = 240.0$	psf
$Y_{fc} = 116$	pcf	$p_{fc} = 406.0$	psf
		$\Delta p = 4051.8$	psf

At Evaluation Point 11:

Top of Final Cover Elevation (ft-msl) = 1085	Waste Thickness = 68.5	ft	
Top of Protective Cover Elevation (ft-msl) = 1013.0	Protective Cover Thickness = 2.0	ft	
Top of Waste Elevation (ft-msl) = 1081.5	Liner Thickness = 2.0	ft	
Top of Liner Elevation (ft-msl) = 1011	Final Cover Thickness = 3.5	ft	
$Y_{waste} = 52$	pcf	$p_{waste} = 3528.7$	psf
$Y_{pc} = 120$	pcf	$p_{pc} = 240.0$	psf
$Y_{liner} = 120$	pcf	$p_{liner} = 240.0$	psf
$Y_{fc} = 116$	pcf	$p_{fc} = 406.0$	psf
		$\Delta p = 4414.7$	psf

Foundation Settlement

Client: City of Del Rio
Project: Major Permit Amendment
Description: Foundation Settlement and Heave Analysis

Date: 3/7/2025
Job No: DELR2000302
By: T. Metaferia
Checked By: B. Hindman

At Evaluation Point 12:

Top of Final Cover Elevation (ft-msl) = 1084	Waste Thickness = 57.5 ft
Top of Protective Cover Elevation (ft-msl) = 1023.0	Protective Cover Thickness = 2.0 ft
Top of Waste Elevation (ft-msl) = 1080.5	Liner Thickness = 2.0 ft
Top of Liner Elevation (ft-msl) = 1021	Final Cover Thickness = 3.5 ft
$\gamma_{waste} = 50$ pcf	$\rho_{waste} = 2871.3$ psf
$\gamma_{pc} = 120$ pcf	$\rho_{pc} = 240.0$ psf
$\gamma_{liner} = 120$ pcf	$\rho_{liner} = 240.0$ psf
$\gamma_{fc} = 116$ pcf	$\rho_{fc} = 406.0$ psf
	$\Delta p = 3757.3$ psf

At Evaluation Point 13:

Top of Final Cover Elevation (ft-msl) = 1093	Waste Thickness = 68.5 ft
Top of Protective Cover Elevation (ft-msl) = 1021.0	Protective Cover Thickness = 2.0 ft
Top of Waste Elevation (ft-msl) = 1089.5	Liner Thickness = 2.0 ft
Top of Liner Elevation (ft-msl) = 1019	Final Cover Thickness = 3.5 ft
$\gamma_{waste} = 52$ pcf	$\rho_{waste} = 3528.7$ psf
$\gamma_{pc} = 120$ pcf	$\rho_{pc} = 240.0$ psf
$\gamma_{liner} = 120$ pcf	$\rho_{liner} = 240.0$ psf
$\gamma_{fc} = 116$ pcf	$\rho_{fc} = 406.0$ psf
	$\Delta p = 4414.7$ psf

At Evaluation Point 14:

Top of Final Cover Elevation (ft-msl) = 1082	Waste Thickness = 54.5 ft
Top of Protective Cover Elevation (ft-msl) = 1024.0	Protective Cover Thickness = 2.0 ft
Top of Waste Elevation (ft-msl) = 1078.5	Liner Thickness = 2.0 ft
Top of Liner Elevation (ft-msl) = 1022	Final Cover Thickness = 3.5 ft
$\gamma_{waste} = 50$ pcf	$\rho_{waste} = 2698.0$ psf
$\gamma_{pc} = 120$ pcf	$\rho_{pc} = 240.0$ psf
$\gamma_{liner} = 120$ pcf	$\rho_{liner} = 240.0$ psf
$\gamma_{fc} = 116$ pcf	$\rho_{fc} = 406.0$ psf
	$\Delta p = 3584.0$ psf

Foundation Settlement

Client: City of Del Rio
Project: Major Permit Amendment
Description: Final Cover Settlement Analysis

Date: 3/7/2025
Job No: DELR2000302
By: T. Metaferia
Checked By: B. Hindman

Evaluation Point 1:

Unit	Top of Elevation (ft-msl)	Bottom Elevation (ft-msl)	H _o (ft)	G _s (ft)	Y _d ¹ (pcf)	Y _w (pcf)	Y _m ¹ (pcf)	w ¹ (%)	e _o ¹	C _c ¹	C _r ¹	p _c ¹ (psf)	p _o (psf)	Δp (psf)	S ² (ft)	H _f (ft)
Stratum III	1018.0	1008.0	10.0	2.65	92.7	62.4	111.1	16.3	0.7310	0.301	0.113	10250.0	555.5	2650.95	0.497	9.5
Stratum III	1008.0	988.0	20.0	2.65	92.7	62.4	111.1	16.3	0.7310	0.301	0.113	10250.0	2222.0	2650.95	0.445	19.6
Stratum III	988.0	968.0	20.0	2.65	92.7	62.4	111.1	16.3	0.7310	0.301	0.113	10250.0	4444.0	2650.95	0.265	19.7
Stratum III	968.0	948.0	20.0	2.65	92.7	62.4	111.1	16.3	0.7310	0.301	0.113	10250.0	6666.0	2650.947	0.190	19.8
Stratum III	948.0	928.0	20.0	2.65	92.7	62.4	111.1	16.3	0.7310	0.301	0.113	10250.0	8888.0	2650.95	0.260	19.7
Stratum III	928.0	908.0	20.0	2.65	92.7	62.4	111.1	16.3	0.7310	0.301	0.113	10250.0	11110.0	2650.95	0.399	19.6
Stratum III	908.0	858.0	50.0	2.65	92.7	62.4	111.1	16.3	0.7310	0.301	0.113	10250.0	14998.5	2650.95	1.512	48.5

3.569

Evaluation Point 2:

Unit	Top of Elevation (ft-msl)	Bottom Elevation (ft-msl)	H _o (ft)	G _s (ft)	Y _d ¹ (pcf)	Y _w (pcf)	Y _m ¹ (pcf)	w ¹ (%)	e _o ¹	C _c ¹	C _r ¹	p _c ¹ (psf)	p _o (psf)	Δp (psf)	S ² (ft)	H _f (ft)
Stratum III	1022.0	1008.0	14.0	2.65	92.7	62.4	111.1	16.3	0.7310	0.301	0.113	10250.0	777.7	4787.92	0.781	13.2
Stratum III	1018.0	998.0	20.0	2.65	92.7	62.4	111.1	16.3	0.7310	0.301	0.113	10250.0	2666.4	4787.92	0.583	19.4
Stratum III	998.0	978.0	20.0	2.65	92.7	62.4	111.1	16.3	0.7310	0.301	0.113	10250.0	4888.4	4787.92	0.387	19.6
Stratum III	978.0	958.0	20.0	2.65	92.7	62.4	111.1	16.3	0.7310	0.301	0.113	10250.0	7110.4	4787.919	0.433	19.6
Stratum III	958.0	938.0	20.0	2.65	92.7	62.4	111.1	16.3	0.7310	0.301	0.113	10250.0	9332.4	4787.92	0.537	19.5
Stratum III	938.0	918.0	20.0	2.65	92.7	62.4	111.1	16.3	0.7310	0.301	0.113	10250.0	11554.4	4787.92	0.637	19.4
Stratum III	918.0	868.0	50.0	2.65	92.7	62.4	111.1	16.3	0.7310	0.301	0.113	10250.0	15442.9	4787.92	1.986	48.0

5.344

Evaluation Point 3:

Unit	Top of Elevation (ft-msl)	Bottom Elevation (ft-msl)	H _o (ft)	G _s (ft)	Y _d ¹ (pcf)	Y _w (pcf)	Y _m ¹ (pcf)	w ¹ (%)	e _o ¹	C _c ¹	C _r ¹	p _c ¹ (psf)	p _o (psf)	Δp (psf)	S ² (ft)	H _f (ft)
Stratum III	1018.0	1008.0	10.0	2.65	92.7	62.4	111.1	16.3	0.7310	0.301	0.113	10250.0	555.5	3025.10	0.528	9.5
Stratum III	1008.0	988.0	20.0	2.65	92.7	62.4	111.1	16.3	0.7310	0.301	0.113	10250.0	2222.0	3025.10	0.487	19.5
Stratum III	988.0	968.0	20.0	2.65	92.7	62.4	111.1	16.3	0.7310	0.301	0.113	10250.0	4444.0	3025.10	0.294	19.7
Stratum III	968.0	948.0	20.0	2.65	92.7	62.4	111.1	16.3	0.7310	0.301	0.113	10250.0	6666.0	3025.104	0.212	19.8
Stratum III	948.0	928.0	20.0	2.65	92.7	62.4	111.1	16.3	0.7310	0.301	0.113	10250.0	8888.0	3025.10	0.308	19.7
Stratum III	928.0	908.0	20.0	2.65	92.7	62.4	111.1	16.3	0.7310	0.301	0.113	10250.0	11110.0	3025.10	0.440	19.6
Stratum III	908.0	858.0	50.0	2.65	92.7	62.4	111.1	16.3	0.7310	0.301	0.113	10250.0	14998.5	3025.10	1.592	48.4

3.861

Foundation Settlement

Client: City of Del Rio
Project: Major Permit Amendment
Description: Final Cover Settlement Analysis

Date: 3/7/2025
Job No: DELR2000302
By: T. Metaferia
Checked By: B. Hindman

Evaluation Point 4:

Unit	Top of Elevation (ft-msl)	Bottom Elevation (ft-msl)	H _o (ft)	G _s (ft)	Y _d ¹ (pcf)	Y _w (pcf)	Y _m ¹ (pcf)	w ¹ (%)	e _o ¹	C _c ¹	C _r ¹	p _c ¹ (psf)	p _o (psf)	Δp (psf)	S ² (ft)	H _f (ft)
Stratum III	1024.0	1008.0	16.0	2.65	92.7	62.4	111.1	16.3	0.7310	0.301	0.113	10250.0	888.8	4292.58	0.800	15.2
Stratum III	1008.0	988.0	20.0	2.65	92.7	62.4	111.1	16.3	0.7310	0.301	0.113	10250.0	2888.6	4292.58	0.516	19.5
Stratum III	988.0	968.0	20.0	2.65	92.7	62.4	111.1	16.3	0.7310	0.301	0.113	10250.0	5110.6	4292.58	0.346	19.7
Stratum III	968.0	948.0	20.0	2.65	92.7	62.4	111.1	16.3	0.7310	0.301	0.113	10250.0	7332.6	4292.579	0.380	19.6
Stratum III	948.0	928.0	20.0	2.65	92.7	62.4	111.1	16.3	0.7310	0.301	0.113	10250.0	9554.6	4292.58	0.494	19.5
Stratum III	928.0	908.0	20.0	2.65	92.7	62.4	111.1	16.3	0.7310	0.301	0.113	10250.0	11776.6	4292.58	0.600	19.4
Stratum III	908.0	858.0	50.0	2.65	92.7	62.4	111.1	16.3	0.7310	0.301	0.113	10250.0	15665.1	4292.58	1.915	48.1

5.051

Evaluation Point 5:

Unit	Top of Elevation (ft-msl)	Bottom Elevation (ft-msl)	H _o (ft)	G _s (ft)	Y _d ¹ (pcf)	Y _w (pcf)	Y _m ¹ (pcf)	w ¹ (%)	e _o ¹	C _c ¹	C _r ¹	p _c ¹ (psf)	p _o (psf)	Δp (psf)	S ² (ft)	H _f (ft)
Stratum III	1018.0	1008.0	10.0	2.65	92.7	62.4	111.1	16.3	0.7310	0.301	0.113	10250.0	555.5	406.00	0.156	9.8
Stratum III	1008.0	988.0	20.0	2.65	92.7	62.4	111.1	16.3	0.7310	0.301	0.113	10250.0	2222.0	406.00	0.095	19.9
Stratum III	988.0	968.0	20.0	2.65	92.7	62.4	111.1	16.3	0.7310	0.301	0.113	10250.0	4444.0	406.00	0.050	20.0
Stratum III	968.0	948.0	20.0	2.65	92.7	62.4	111.1	16.3	0.7310	0.301	0.113	10250.0	6666.0	406	0.034	20.0
Stratum III	948.0	928.0	20.0	2.65	92.7	62.4	111.1	16.3	0.7310	0.301	0.113	10250.0	8888.0	406.00	0.025	20.0
Stratum III	928.0	908.0	20.0	2.65	92.7	62.4	111.1	16.3	0.7310	0.301	0.113	10250.0	11110.0	406.00	0.130	19.9
Stratum III	908.0	858.0	50.0	2.65	92.7	62.4	111.1	16.3	0.7310	0.301	0.113	10250.0	14998.5	406.00	0.999	49.0

1.488

Evaluation Point 6:

Unit	Top of Elevation (ft-msl)	Bottom Elevation (ft-msl)	H _o (ft)	G _s (ft)	Y _d ¹ (pcf)	Y _w (pcf)	Y _m ¹ (pcf)	w ¹ (%)	e _o ¹	C _c ¹	C _r ¹	p _c ¹ (psf)	p _o (psf)	Δp (psf)	S ² (ft)	H _f (ft)
Stratum III	1025.0	1008.0	17.0	2.65	92.7	62.4	111.1	16.3	0.7310	0.301	0.113	10250.0	944.4	406.00	0.172	16.8
Stratum III	1008.0	988.0	20.0	2.65	92.7	62.4	111.1	16.3	0.7310	0.301	0.113	10250.0	2999.7	406.00	0.072	19.9
Stratum III	988.0	968.0	20.0	2.65	92.7	62.4	111.1	16.3	0.7310	0.301	0.113	10250.0	5221.7	406.00	0.042	20.0
Stratum III	968.0	948.0	20.0	2.65	92.7	62.4	111.1	16.3	0.7310	0.301	0.113	10250.0	7443.7	406	0.030	20.0
Stratum III	948.0	928.0	20.0	2.65	92.7	62.4	111.1	16.3	0.7310	0.301	0.113	10250.0	9665.7	406.00	0.023	20.0
Stratum III	928.0	908.0	20.0	2.65	92.7	62.4	111.1	16.3	0.7310	0.301	0.113	10250.0	11887.7	406.00	0.191	19.8
Stratum III	908.0	858.0	50.0	2.65	92.7	62.4	111.1	16.3	0.7310	0.301	0.113	10250.0	15776.2	406.00	1.113	48.9

1.644

Foundation Settlement

Client: City of Del Rio
Project: Major Permit Amendment
Description: Final Cover Settlement Analysis

Date: 3/7/2025
Job No: DELR2000302
By: T. Metaferia
Checked By: B. Hindman

Evaluation Point 7:

Unit	Top of Elevation (ft-msl)	Bottom Elevation (ft-msl)	H _o (ft)	G _s (ft)	Y _d ¹ (pcf)	Y _w (pcf)	Y _m ¹ (pcf)	w ¹ (%)	e _o ¹	C _c ¹	C _r ¹	p _c ¹ (psf)	p _o (psf)	Δp (psf)	S ² (ft)	H _f (ft)
Stratum III	1013.0	1008.0	5.0	2.65	92.7	62.4	111.1	16.3	0.7310	0.301	0.113	10250.0	277.8	406.00	0.128	4.9
Stratum III	1008.0	988.0	20.0	2.65	92.7	62.4	111.1	16.3	0.7310	0.301	0.113	10250.0	1666.5	406.00	0.124	19.9
Stratum III	988.0	968.0	20.0	2.65	92.7	62.4	111.1	16.3	0.7310	0.301	0.113	10250.0	3888.5	406.00	0.056	19.9
Stratum III	968.0	948.0	20.0	2.65	92.7	62.4	111.1	16.3	0.7310	0.301	0.113	10250.0	6110.5	406	0.036	20.0
Stratum III	948.0	928.0	20.0	2.65	92.7	62.4	111.1	16.3	0.7310	0.301	0.113	10250.0	8332.5	406.00	0.027	20.0
Stratum III	928.0	908.0	20.0	2.65	92.7	62.4	111.1	16.3	0.7310	0.301	0.113	10250.0	10554.5	406.00	0.085	19.9
Stratum III	908.0	858.0	50.0	2.65	92.7	62.4	111.1	16.3	0.7310	0.301	0.113	10250.0	14443.0	406.00	0.913	49.1

1.369

Evaluation Point 8:

Unit	Top of Elevation (ft-msl)	Bottom Elevation (ft-msl)	H _o (ft)	G _s (ft)	Y _d ¹ (pcf)	Y _w (pcf)	Y _m ¹ (pcf)	w ¹ (%)	e _o ¹	C _c ¹	C _r ¹	p _c ¹ (psf)	p _o (psf)	Δp (psf)	S ² (ft)	H _f (ft)
Stratum III	1019.0	1008.0	11.0	2.65	92.7	62.4	111.1	16.3	0.7310	0.301	0.113	10250.0	611.1	406.00	0.159	10.8
Stratum III	1008.0	988.0	20.0	2.65	92.7	62.4	111.1	16.3	0.7310	0.301	0.113	10250.0	2333.1	406.00	0.091	19.9
Stratum III	988.0	968.0	20.0	2.65	92.7	62.4	111.1	16.3	0.7310	0.301	0.113	10250.0	4555.1	406.00	0.048	20.0
Stratum III	968.0	948.0	20.0	2.65	92.7	62.4	111.1	16.3	0.7310	0.301	0.113	10250.0	6777.1	406	0.033	20.0
Stratum III	948.0	928.0	20.0	2.65	92.7	62.4	111.1	16.3	0.7310	0.301	0.113	10250.0	8999.1	406.00	0.025	20.0
Stratum III	928.0	908.0	20.0	2.65	92.7	62.4	111.1	16.3	0.7310	0.301	0.113	10250.0	11221.1	406.00	0.139	19.9
Stratum III	908.0	858.0	50.0	2.65	92.7	62.4	111.1	16.3	0.7310	0.301	0.113	10250.0	15109.6	406.00	1.015	49.0

1.511

Evaluation Point 9:

Unit	Top of Elevation (ft-msl)	Bottom Elevation (ft-msl)	H _o (ft)	G _s (ft)	Y _d ¹ (pcf)	Y _w (pcf)	Y _m ¹ (pcf)	w ¹ (%)	e _o ¹	C _c ¹	C _r ¹	p _c ¹ (psf)	p _o (psf)	Δp (psf)	S ² (ft)	H _f (ft)
Stratum III	1012.0	1008.0	4.0	2.65	92.7	62.4	111.1	16.3	0.7310	0.301	0.113	10250.0	222.2	406.00	0.118	3.9
Stratum III	1008.0	988.0	20.0	2.65	92.7	62.4	111.1	16.3	0.7310	0.301	0.113	10250.0	1555.4	406.00	0.132	19.9
Stratum III	988.0	968.0	20.0	2.65	92.7	62.4	111.1	16.3	0.7310	0.301	0.113	10250.0	3777.4	406.00	0.058	19.9
Stratum III	968.0	948.0	20.0	2.65	92.7	62.4	111.1	16.3	0.7310	0.301	0.113	10250.0	5999.4	406	0.037	20.0
Stratum III	948.0	928.0	20.0	2.65	92.7	62.4	111.1	16.3	0.7310	0.301	0.113	10250.0	8221.4	406.00	0.027	20.0
Stratum III	928.0	908.0	20.0	2.65	92.7	62.4	111.1	16.3	0.7310	0.301	0.113	10250.0	10443.4	406.00	0.075	19.9
Stratum III	908.0	858.0	50.0	2.65	92.7	62.4	111.1	16.3	0.7310	0.301	0.113	10250.0	14331.9	406.00	0.896	49.1

1.343

Foundation Settlement

Client: City of Del Rio
Project: Major Permit Amendment
Description: Final Cover Settlement Analysis

Date: 3/7/2025
Job No: DELR2000302
By: T. Metaferia
Checked By: B. Hindman

Evaluation Point 10:

Unit	Top of Elevation (ft-msl)	Bottom Elevation (ft-msl)	H _o (ft)	G _s (ft)	Y _d ¹ (pcf)	Y _w (pcf)	Y _m ¹ (pcf)	w ¹ (%)	e _o ¹	C _c ¹	C _r ¹	P _c ¹ (psf)	P _o (psf)	Δp (psf)	S ² (ft)	H _f (ft)
Stratum III	1020.0	1008.0	12.0	2.65	92.7	62.4	111.1	16.3	0.7310	0.301	0.113	10250.0	666.6	240.00	0.105	11.9
Stratum III	1008.0	988.0	20.0	2.65	92.7	62.4	111.1	16.3	0.7310	0.301	0.113	10250.0	2444.2	240.00	0.053	19.9
Stratum III	988.0	968.0	20.0	2.65	92.7	62.4	111.1	16.3	0.7310	0.301	0.113	10250.0	4666.2	240.00	0.028	20.0
Stratum III	968.0	948.0	20.0	2.65	92.7	62.4	111.1	16.3	0.7310	0.301	0.113	10250.0	6888.2	240	0.019	20.0
Stratum III	948.0	928.0	20.0	2.65	92.7	62.4	111.1	16.3	0.7310	0.301	0.113	10250.0	9110.2	240.00	0.015	20.0
Stratum III	928.0	908.0	20.0	2.65	92.7	62.4	111.1	16.3	0.7310	0.301	0.113	10250.0	11332.2	240.00	0.126	19.9
Stratum III	908.0	858.0	50.0	2.65	92.7	62.4	111.1	16.3	0.7310	0.301	0.113	10250.0	15220.7	240.00	0.992	49.0

1.338

Evaluation Point 11:

Unit	Top of Elevation (ft-msl)	Bottom Elevation (ft-msl)	H _o (ft)	G _s (ft)	Y _d ¹ (pcf)	Y _w (pcf)	Y _m ¹ (pcf)	w ¹ (%)	e _o ¹	C _c ¹	C _r ¹	P _c ¹ (psf)	P _o (psf)	Δp (psf)	S ² (ft)	H _f (ft)
Stratum III	1009.0	1008.0	1.0	2.65	92.7	62.4	111.1	16.3	0.7310	0.301	0.113	10250.0	55.6	240.00	0.047	1.0
Stratum III	1008.0	988.0	20.0	2.65	92.7	62.4	111.1	16.3	0.7310	0.301	0.113	10250.0	1222.1	240.00	0.102	19.9
Stratum III	988.0	968.0	20.0	2.65	92.7	62.4	111.1	16.3	0.7310	0.301	0.113	10250.0	3444.1	240.00	0.038	20.0
Stratum III	968.0	948.0	20.0	2.65	92.7	62.4	111.1	16.3	0.7310	0.301	0.113	10250.0	5666.1	240	0.024	20.0
Stratum III	948.0	928.0	20.0	2.65	92.7	62.4	111.1	16.3	0.7310	0.301	0.113	10250.0	7888.1	240.00	0.017	20.0
Stratum III	928.0	908.0	20.0	2.65	92.7	62.4	111.1	16.3	0.7310	0.301	0.113	10250.0	10110.1	240.00	0.022	20.0
Stratum III	908.0	858.0	50.0	2.65	92.7	62.4	111.1	16.3	0.7310	0.301	0.113	10250.0	13998.6	240.00	0.799	49.2

1.049

Evaluation Point 12:

Unit	Top of Elevation (ft-msl)	Bottom Elevation (ft-msl)	H _o (ft)	G _s (ft)	Y _d ¹ (pcf)	Y _w (pcf)	Y _m ¹ (pcf)	w ¹ (%)	e _o ¹	C _c ¹	C _r ¹	P _c ¹ (psf)	P _o (psf)	Δp (psf)	S ² (ft)	H _f (ft)
Stratum III	1019.0	1008.0	11.0	2.65	92.7	62.4	111.1	16.3	0.7310	0.301	0.113	10250.0	611.1	240.00	0.103	10.9
Stratum III	1008.0	988.0	20.0	2.65	92.7	62.4	111.1	16.3	0.7310	0.301	0.113	10250.0	2333.1	240.00	0.056	19.9
Stratum III	988.0	968.0	20.0	2.65	92.7	62.4	111.1	16.3	0.7310	0.301	0.113	10250.0	4555.1	240.00	0.029	20.0
Stratum III	968.0	948.0	20.0	2.65	92.7	62.4	111.1	16.3	0.7310	0.301	0.113	10250.0	6777.1	240	0.020	20.0
Stratum III	948.0	928.0	20.0	2.65	92.7	62.4	111.1	16.3	0.7310	0.301	0.113	10250.0	8999.1	240.00	0.015	20.0
Stratum III	928.0	908.0	20.0	2.65	92.7	62.4	111.1	16.3	0.7310	0.301	0.113	10250.0	11221.1	240.00	0.117	19.9
Stratum III	908.0	858.0	50.0	2.65	92.7	62.4	111.1	16.3	0.7310	0.301	0.113	10250.0	15109.6	240.00	0.975	49.0

1.315

Foundation Settlement

Client: City of Del Rio
Project: Major Permit Amendment
Description: Final Cover Settlement Analysis

Date: 3/7/2025
Job No: DELR2000302
By: T. Metaferia
Checked By: B. Hindman

Evaluation Point 13:

Unit	Top of Elevation (ft-msl)	Bottom Elevation (ft-msl)	H _o (ft)	G _s (ft)	Y _d ¹ (pcf)	Y _w (pcf)	Y _m ¹ (pcf)	w ¹ (%)	e _o ¹	C _c ¹	C _r ¹	p _c ¹ (psf)	p _o (psf)	Δp (psf)	S ² (ft)	H _f (ft)
Stratum III	1017.0	1008.0	9.0	2.65	92.7	62.4	111.1	16.3	0.7310	0.301	0.113	10250.0	500.0	240.00	0.100	8.9
Stratum III	1008.0	988.0	20.0	2.65	92.7	62.4	111.1	16.3	0.7310	0.301	0.113	10250.0	2110.9	240.00	0.061	19.9
Stratum III	988.0	968.0	20.0	2.65	92.7	62.4	111.1	16.3	0.7310	0.301	0.113	10250.0	4332.9	240.00	0.031	20.0
Stratum III	968.0	948.0	20.0	2.65	92.7	62.4	111.1	16.3	0.7310	0.301	0.113	10250.0	6554.9	240	0.020	20.0
Stratum III	948.0	928.0	20.0	2.65	92.7	62.4	111.1	16.3	0.7310	0.301	0.113	10250.0	8776.9	240.00	0.015	20.0
Stratum III	928.0	908.0	20.0	2.65	92.7	62.4	111.1	16.3	0.7310	0.301	0.113	10250.0	10998.9	240.00	0.099	19.9
Stratum III	908.0	858.0	50.0	2.65	92.7	62.4	111.1	16.3	0.7310	0.301	0.113	10250.0	14887.4	240.00	0.941	49.1

1.267

Evaluation Point 14:

Unit	Top of Elevation (ft-msl)	Bottom Elevation (ft-msl)	H _o (ft)	G _s (ft)	Y _d ¹ (pcf)	Y _w (pcf)	Y _m ¹ (pcf)	w ¹ (%)	e _o ¹	C _c ¹	C _r ¹	p _c ¹ (psf)	p _o (psf)	Δp (psf)	S ² (ft)	H _f (ft)
Stratum III	1020.0	1008.0	12.0	2.65	92.7	62.4	111.1	16.3	0.7310	0.301	0.113	10250.0	666.6	240.00	0.105	11.9
Stratum III	1008.0	988.0	20.0	2.65	92.7	62.4	111.1	16.3	0.7310	0.301	0.113	10250.0	2444.2	240.00	0.053	19.9
Stratum III	988.0	968.0	20.0	2.65	92.7	62.4	111.1	16.3	0.7310	0.301	0.113	10250.0	4666.2	240.00	0.028	20.0
Stratum III	968.0	948.0	20.0	2.65	92.7	62.4	111.1	16.3	0.7310	0.301	0.113	10250.0	6888.2	240	0.019	20.0
Stratum III	948.0	928.0	20.0	2.65	92.7	62.4	111.1	16.3	0.7310	0.301	0.113	10250.0	9110.2	240.00	0.015	20.0
Stratum III	928.0	908.0	20.0	2.65	92.7	62.4	111.1	16.3	0.7310	0.301	0.113	10250.0	11332.2	240.00	0.126	19.9
Stratum III	908.0	858.0	50.0	2.65	92.7	62.4	111.1	16.3	0.7310	0.301	0.113	10250.0	15220.7	240.00	0.992	49.0

1.338

Summary of LCS and Liner Slopes After Settlement

Client: City of Del Rio
Project: Major Permit Amendment
Description: Final Cover Settlement Analysis

Date: 3/7/2025
Job No: DELR2000302
By: T. Metaferia
Checked By: B. Hindman

Slope from Evaluation Point 2 to Evaluation Point 1:

Prior to Settlement				Estimated Settlement		After Settlement			
Length	Elevation Point 2 (ft-msl)	Elevation Point 1 (ft-msl)	Slope (%)	Elevation Point 2 (ft-msl)	Elevation Point 1 (ft-msl)	Length	Elevation Point 2 (ft-msl)	Elevation Point 1 (ft-msl)	Slope (%)
223.5	1024.0	1020.0	1.79%	5.344	3.569	223.5	1018.7	1016.43	1.0%

Slope from Evaluation Point 4 to Evaluation Point 3:

Prior to Settlement				Estimated Settlement		After Settlement			
Length	Elevation Point 4 (ft-msl)	Elevation Point 3 (ft-msl)	Slope (%)	Elevation Point 4 (ft-msl)	Elevation Point 3 (ft-msl)	Length	Elevation Point 4 (ft-msl)	Elevation Point 3 (ft-msl)	Slope (%)
443.2	1026.0	1020.0	1.35%	5.051	3.861	443.2	1020.9	1016.14	1.1%

Slope from Evaluation Point 6 to Evaluation Point 5:

Prior to Settlement				Estimated Settlement		After Settlement			
Length	Elevation Point 6 (ft-msl)	Elevation Point 5 (ft-msl)	Slope (%)	Elevation Point 6 (ft-msl)	Elevation Point 5 (ft-msl)	Length	Elevation Point 6 (ft-msl)	Elevation Point 5 (ft-msl)	Slope (%)
553.5	1027.0	1020.0	1.26%	1.644	1.488	553.5	1025.4	1018.51	1.2%

Slope from Evaluation Point 8 to Evaluation Point 7:

Prior to Settlement				Estimated Settlement		After Settlement			
Length	Elevation Point 8 (ft-msl)	Elevation Point 7 (ft-msl)	Slope (%)	Elevation Point 8 (ft-msl)	Elevation Point 7 (ft-msl)	Length	Elevation Point 8 (ft-msl)	Elevation Point 7 (ft-msl)	Slope (%)
544.8	1021.0	1015.0	1.10%	1.511	1.369	544.8	1019.5	1013.63	1.1%

Slope from Evaluation Point 10 to Evaluation Point 9:

Prior to Settlement				Estimated Settlement		After Settlement			
Length	Elevation Point 10 (ft-msl)	Elevation Point 9 (ft-msl)	Slope (%)	Elevation Point 10 (ft-msl)	Elevation Point 9 (ft-msl)	Length	Elevation Point 10 (ft-msl)	Elevation Point 9 (ft-msl)	Slope (%)
757.5	1022.0	1014.0	1.06%	1.338	1.343	757.5	1020.7	1012.66	1.1%

Slope from Evaluation Point 12 to Evaluation Point 11:

Prior to Settlement				Estimated Settlement		After Settlement			
Length	Elevation Point 12 (ft-msl)	Elevation Point 11 (ft-msl)	Slope (%)	Elevation Point 12 (ft-msl)	Elevation Point 11 (ft-msl)	Length	Elevation Point 12 (ft-msl)	Elevation Point 11 (ft-msl)	Slope (%)
752.2	1021.0	1011.0	1.33%	1.315	1.267	752.2	1019.7	1009.73	1.3%

Slope from Evaluation Point 14 to Evaluation Point 13:

Prior to Settlement				Estimated Settlement		After Settlement			
Length	Elevation Point 14 (ft-msl)	Elevation Point 13 (ft-msl)	Slope (%)	Elevation Point 14 (ft-msl)	Elevation Point 13 (ft-msl)	Length	Elevation Point 14 (ft-msl)	Elevation Point 13 (ft-msl)	Slope (%)
291.7	1022.0	1019.0	1.03%	1.338	1.267	291.7	1020.7	1017.73	1.0%

Conclusions:

The above calculations verify that the slopes and lengths used to design the leachate collection system in Appendix IIC are valid. As noted in Appendix IIC-A, the slope between the sector ridgeline and leachate collection line used in the HELP Model analysis was chosen to be 1.0 %, which approximates the lowest post-settlement slope. Slopes of the primary collection lines remain positive post-settlement, with flattening of the primary collection lines occurring during landfill filling (as the height of the fill over the lines increases) and post-filling and closure of the landfill. Slopes of the primary collection lines remain positive over the filling and closure of the landfill.

Leachate Collection System and Liner Strain

Client: City of Del Rio
Project: Major Permit Amendment
Description: Foundation Settlement and Heave Analysis

Date: 3/7/2025
Job No: DELR2000302
By: T. Metaferia
Checked By: B. Hindman

Step 1 - Determine the strain percentage in the Subtitle D liner system based on the total settlement between the evaluation points.

Strain Equation

$$\text{Strain} = \frac{L_f - L_o}{L_o} * 100$$

Where: L_f = Final distance between evaluation points after total settlement (ft)
 L_o = Initial distance between evaluation points before settlement (ft)

Note: A negative strain value indicates the component is in compression. A positive strain value indicates the components is in tension.

Calculated Strain between Evaluation Points

Evaluation Point		Initial Evaluation (ft-msl)		Post-Settlement Elevation (ft-msl)		Plan View Distance (ft)	L_o (ft)	L_f (ft)	Strain (%)
A	B	A	B	A	B				
2	1	1024	1020	5.34	3.57	223.5	223.54	223.51	0.0129%
4	3	1026	1020	5.05	3.86	443.2	443.24	443.20	0.0088%
6	5	1027	1020	1.64	1.49	553.5	553.54	553.50	0.0080%
8	7	1021	1015	1.51	1.37	544.8	544.83	544.80	0.0061%
10	9	1022	1014	1.34	1.34	757.5	757.54	757.50	0.0056%
12	11	1021	1019	1.31	1.27	752.2	752.20	752.20	0.0004%
14	13	1022	1019	1.34	1.27	291.7	291.72	291.70	0.0053%

Conclusions:

The allowable tensile strain for a drainage geocomposite is more than 20% for the geotextile and 200% for the geonet. Reference: Koerner, Robert M., *Designing with Geosynthetics*, Third Edition. Prentice-Hall, New Jersey, 1994. (pages 112 and 400)

The allowable tensile strain for compacted clay liner is 0.5%

Reference: Quian, Xuede, R.M. Koerner, D. H. Gray, *Geotechnical Aspects of Landfill Design and Construction*, Prentice-Hall, Inc., New Jersey, 2002. (page 469)

The calculated strains show in the above table are negative, which represent compressive strain.

Strain is acceptable

Heave Analysis

Client: City of Del Rio
Project: Major Permit Amendment
Description: Foundation Settlement and Heave Analysis

Date: 3/7/2025
Job No: DELR2000302
By: T. Metaferia
Checked By: B. Hindman

Estimate the potential heave of the excavation bottom that may occur due to the excavation of overburden soils. Using standard consolidation theory.

Note: Approximate evaluation location for the heave analysis is shown on Sheet IILL-B-1-2, Point 10.

Where:

- C_{ss} = Swell index, ft
- γ = Unit weight of soil, pcf
- e_o = Initial void ratio
- P_o = Present overburden pressure, psf
- ΔP = Change in overburden pressure, psf
- D = Depth of excavation, ft
- H_i = Depth of shale layer, ft

Material properties of the soil material to be excavated at the site based on laboratory test results.

Stratum II			Stratum III		
	$\gamma_{II(Dry)}$	95.8		$\gamma_{III(Dry)}$	95.5
Natural Moisture Content		16.2%	Natural Moisture Content		16.3%
	$\gamma_{II(in-situ)}$	111.3		$\gamma_{III(in-situ)}$	111.1
	C_{ss}	0.1127			
	e_o	0.731			
	H_i	150			

The change in loading is due to excavation of overburden soils.

The maximum depth of excavation is approximately = 30 ft
 Number of Soil layers = 2

$$\Delta P = D_{II} * \gamma_{II(in-situ)} + D_I * \gamma_{I(in-situ)}$$

D_{II} = 10 ft
 D_I = 20 ft
 ΔP = 3335 psf

Using the standard consolidation theory:

$$S = C_{SS} * H_i * \log \frac{P_o - \Delta P}{P_o}$$

$$P_o = \frac{H_i}{2} * \gamma_{(moist, in-situ)} + \Delta P$$

P_o = 11683 psf
 Projected Heave S = -2.47 ft

References:

Terzaghi, Karl and Peck, Ralph, *Soil Mechanics in Engineering Principle*, Third Edition, John Wiley and Sons, Inc, New York, 1996.
 Das, Braja M., *Principles of Geotechnical Engineering*, Fourth Edition, PWS, Boston, 1998.
 Day, Robert W., *Geotechnical Engineer's Portable Handbook*, McGraw-Hill, New York, 2000.

FINAL COVER SYSTEM SETTLEMENT ANALYSIS

Final Cover Settlement Analysis

Client: City of Del Rio
Project: Major Permit Amendment
Description: Final Cover Settlement Analysis

Date: 3/7/2025
Job No: DELR2000302
By: T. Metaferia
Checked By: B. Hindman

Purpose -

- Estimate primary settlement of waste below the final cover system.
- Estimate secondary settlement of waste below the final cover system.
- Estimate total settlement of waste below the final cover system.
- Verify that strain induced on the final cover due to settlement is within acceptable limits.

References:

- 1 Sowers, George F., Settlement of Solid Waste, Proceedings of the Eighth International Conference on Soil Mechanics and Foundations Engineering, 1973.
- 2 Quian, Xuede, R.M. Koerner, D. H. Gray, Geotechnical Aspects of Landfill Design and Construction, Prentice-Hall, Inc., New Jersey, 2002.
- 3 Koerner, Robert M., Designing with Geosynthetics, Third Edition. Prentice-Hall, New Jersey, 1994.
- 4 Acar, Yalcin B. & Daniel, David E., Geoenvironment 2000 Characterization, Containment, Remediation, and Performance in Environmental Geotechnics, Volume 2, American Society of Civil Engineers, 1995.
- 5 Zornberg, Jorge G., et al., Retention of Free Liquids in Landfills Undergoing Vertical Expansion, Journal of Geotechnical and Geoenvironmental Engineering, July 1999.
- 6 Fassett, Jeffrey B., et al., Geotechnical Properties of Municipal Solid Wastes and Their Use in Landfill Design, Waste Tech, 1994.

Step 1 - Select critical location for settlement.

Evaluation point locations are shown on Sheet IILL-B-18

LEGEND

	SETTLEMENT EVALUATION POINT		PERMIT BOUNDARY
	CHUTES		CLOSED CELL BOUNDARY
	PROPOSED GAS PROBE		LIMIT OF WASTE
	PROPOSED GAS VENTS		FINAL COVER CONTOURS
			EXISTING CONTOURS
			PERIMETER CHANNEL
			SWALES
			EXISTING SITE FENCE
			PROPOSED SITE FENCE
			EXISTING CHUTE

0 200 400
SCALE IN FEET

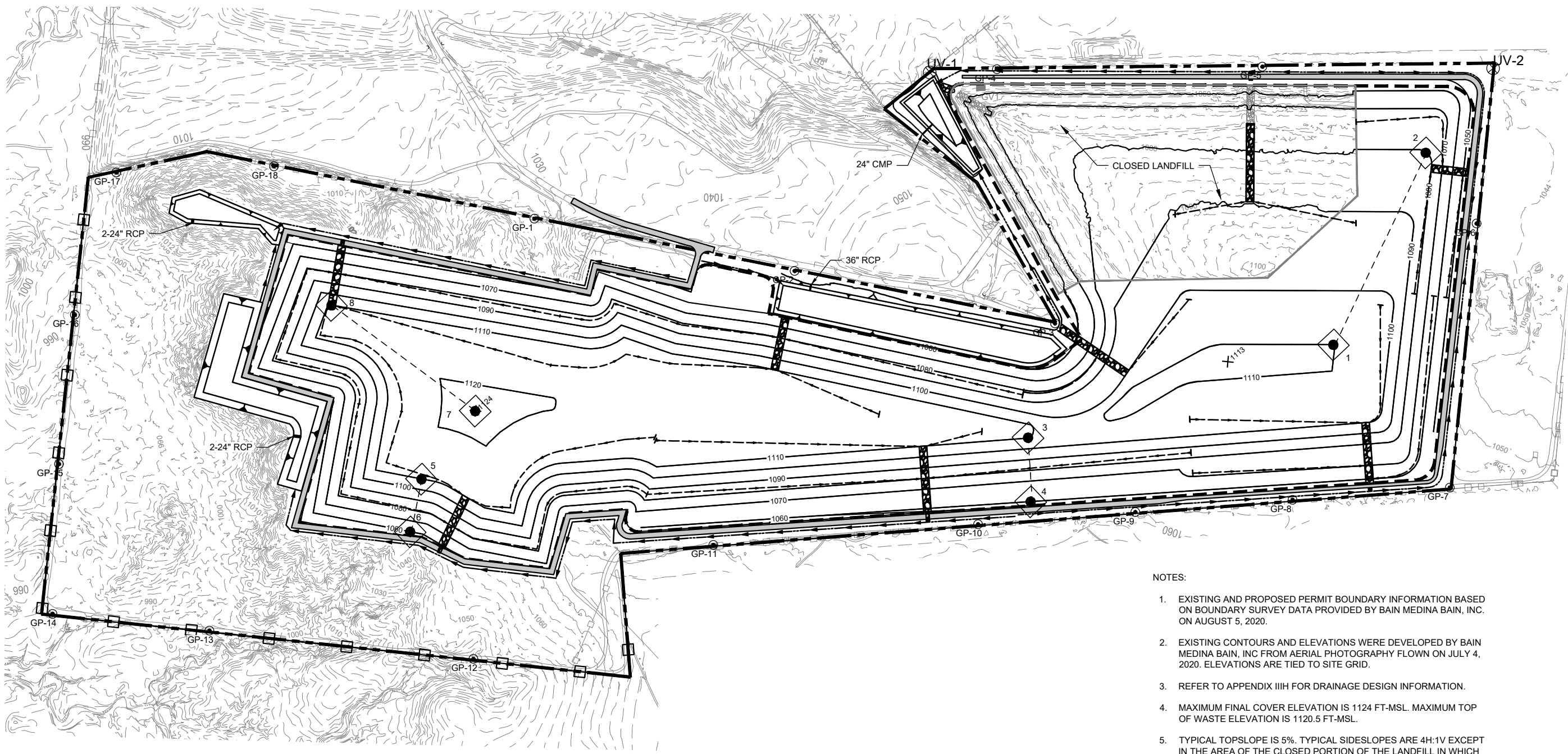

- NOTES:**
- EXISTING AND PROPOSED PERMIT BOUNDARY INFORMATION BASED ON BOUNDARY SURVEY DATA PROVIDED BY BAIN MEDINA BAIN, INC. ON AUGUST 5, 2020.
 - EXISTING CONTOURS AND ELEVATIONS WERE DEVELOPED BY BAIN MEDINA BAIN, INC FROM AERIAL PHOTOGRAPHY FLOWN ON JULY 4, 2020. ELEVATIONS ARE TIED TO SITE GRID.
 - REFER TO APPENDIX IIIH FOR DRAINAGE DESIGN INFORMATION.
 - MAXIMUM FINAL COVER ELEVATION IS 1124 FT-MSL. MAXIMUM TOP OF WASTE ELEVATION IS 1120.5 FT-MSL.
 - TYPICAL TOPSLOPE IS 5%. TYPICAL SIDESLOPES ARE 4H:1V EXCEPT IN THE AREA OF THE CLOSED PORTION OF THE LANDFILL IN WHICH THE SIDESLOPES ARE 5H:1V.

an STV Company
TEXAS REGISTERED ENGINEERING FIRM
TBPE F-1741

DEL RIO
P.E.A.S.

STATE OF TEXAS
T. METAFERIA
123183
PROFESSIONAL ENGINEER
EXPIRES 08/07/2025

NO.	REVISION	BY	DATE
1.	2nd TECHNICAL NOD	STV	03/2025

VERIFY SCALE BAR LENGTH EQUALS ONE INCH ON ORIGINAL DRAWING. VERIFY LENGTH ON THIS SHEET 0" AND ADJUST SCALE ACCORDINGLY.

CITY OF DEL RIO LANDFILL NO. 207C
MAJOR PERMIT AMENDMENT

FINAL COVER SETTLEMENT
EVALUATION POINTS

DESIGN: T. METAFERIA
DRAWN: T. METAFERIA
REVIEW: B. HINDMAN
CP&Y: DELR200302
CLIENT: CITY OF DEL RIO

FIGURE
IIII-B-18

FOR PERMITTING PURPOSES ONLY

PRINTED BY: Metaferia
FILE PATH: C:\pwworking\stvw_s\metaferia\0942279\DELR200302\Figure IIII-B-5 FC Settlement Evaluation

Final Cover Settlement Analysis

Client: City of Del Rio
Project: Major Permit Amendment
Description: Final Cover Settlement Analysis

Date: 8/7/2024
Job No: DELR2000302
By: T. Metaferia
Checked By: B. Hindman

Purpose - Determine the post-settlement slope of the final cover system and verify that the strain induced on the final cover due to settlement is within acceptable limits.

Step 1 - Estimate primary settlement of waste below the final cover system:

MSW will undergo primary consolidation due to its own weight, final cover, equipment, etc. Primary consolidation occurs quickly, generally within the first month after loading. Therefore, the weight of the final cover system is the only remaining factor that contributes to primary consolidation. In addition, by the time the construction of the final cover is complete, settlement of the waste due to the weight of the final cover will be complete.

Primary settlement is calculated using the following equation:

$$S_p = \frac{H_o C_c}{1 + e_o} \log \left(\frac{\sigma'_o + \Delta\sigma}{\sigma'_o} \right)$$

Where:

- S_p = Primary settlement, ft
- H_o = Waste thickness below the final cover before settlement, ft
- C_c = Compression index
- e_o = Void ratio of the waste layer below final cover before settlement (i.e., before final cover placement)
- σ'_o = Overburden pressure acting at mid-height of refuse below the final cover, psf
- $\Delta\sigma$ = Change in loading/increase in overburden pressure, psf

For this site, assume: $C_c = 0.35e_o$ (Ref. 1, p. 210)

The compression index is a function of the void ratio. The compression index can range from $C_c = 0.15e_o$ to $C_c = 0.55e_o$ for fills that are low and high in organic content, respectively. An average compression index value was chosen because it is consistent with the types of waste accepted in the past. It is also representative of the minimal amount of settlement the site has experienced.

The average void ratio of waste below the final cover is estimated by determining the void ratio at the midpoint of the waste column below the final cover system. The void ratio is calculated for each settlement evaluation point using the following equation.

$$e_o = 1.86 - 0.00102\sigma'_o \quad (\text{Ref. 5, pg 590})$$

Where:

- e_o = Void ratio of the waste layer below final cover before settlement (i.e., before final cover placement)
- σ'_o = Overburden pressure, kPa

$$\sigma'_o = 0.5\gamma_{msw}H_o$$

$$\Delta\sigma = \gamma_{cov}T_c$$

- γ_{msw} = Unit weight of waste below the final cover system, pcf
- γ_{cov} = Unit weight of cover, pcf
- T_c = Thickness of final cover system, ft

Parameters:

- γ_{cov} = 116 pcf
- T_c = 3.0 ft
- γ_{msw} = varies (see note below)

Note: γ_{msw} is selected based on the midpoint of the waste thicknesses below the final cover system using the Unit Weight Profile for Waste/Daily Cover within an MSW Landfill chart from Ref. 4.

Final Cover Settlement Analysis

Client: City of Del Rio
Project: Major Permit Amendment
Description: Final Cover Settlement Analysis

Date: 8/7/2024
Job No: DELR2000302
By: T. Metaferia
Checked By: B. Hindman

The settlement points analyzed are shown on Sheet IILL-B-17. An example calculation of the estimated primary settlement is shown below for Evaluation Points 1 and 2.

At Evaluation Point 1:

$$\begin{aligned}\text{Top of Final Cover Elevation (ft-msl)} &= 1110 \\ \text{Bottom of Waste Elevation (ft-msl)} &= 1045 \\ H_o &= 62 \quad \text{ft} \\ \gamma_{msw} &= 51 \quad \text{pcf}\end{aligned}$$

$$\begin{aligned}\sigma'_o &= 0.5\gamma_{msw}H_o \\ \sigma'_o &= 1568.01 \quad \text{psf} \\ \sigma'_o &= 75.1 \quad \text{kPa}\end{aligned}$$

$$\begin{aligned}e_o &= 1.86 - 0.00102\sigma'_o \\ e_o &= 1.78\end{aligned}$$

$$\begin{aligned}C_c &= 0.35e_o \\ C_c &= 0.62\end{aligned}$$

$$\begin{aligned}\Delta\sigma &= \gamma_{cov}T_c \\ \Delta\sigma &= 348 \quad \text{psf}\end{aligned}$$

$$\begin{aligned}S_p &= \frac{H_o C_c}{1 + e_o} \log\left(\frac{\sigma'_o + \Delta\sigma}{\sigma'_o}\right) \\ S_p &= 1.21 \quad \text{ft}\end{aligned}$$

At Evaluation Point 2:

$$\begin{aligned}\text{Top of Final Cover Elevation (ft-msl)} &= 1080.0 \\ \text{Bottom of Waste Elevation (ft-msl)} &= 1027.0 \\ H_o &= 50 \quad \text{ft} \\ \gamma_{msw} &= 49 \quad \text{pcf}\end{aligned}$$

$$\begin{aligned}\sigma'_o &= 0.5\gamma_{msw}H_o \\ \sigma'_o &= 1221.48 \quad \text{psf} \\ \sigma'_o &= 58.5 \quad \text{kPa}\end{aligned}$$

$$\begin{aligned}e_o &= 1.86 - 0.00102\sigma'_o \\ e_o &= 1.80\end{aligned}$$

$$\begin{aligned}C_c &= 0.35e_o \\ C_c &= 0.63\end{aligned}$$

$$\begin{aligned}\Delta\sigma &= \gamma_{cov}T_c \\ \Delta\sigma &= 348 \quad \text{psf}\end{aligned}$$

$$\begin{aligned}S_p &= \frac{H_o C_c}{1 + e_o} \log\left(\frac{\sigma'_o + \Delta\sigma}{\sigma'_o}\right) \\ S_p &= 1.22 \quad \text{ft}\end{aligned}$$

Final Cover Settlement Analysis

Client: City of Del Rio
Project: Major Permit Amendment
Description: Final Cover Settlement Analysis

Date: 8/7/2024
Job No: DELR2000302
By: T. Metaferia
Checked By: B. Hindman

Step 2 - Estimate secondary settlement of waste below the final cover system.

Secondary consolidation continues at substantial rates for periods of time well beyond primary settlement. It is a combination of mechanical secondary compression, physio-chemical reaction, and bio-chemical decay. The settlement-log time relationship is similar to secondary compression of soils and can be expressed by:

$$S_c = \frac{H'_o \alpha}{1 + e'_o} \log \left(\frac{t_1}{t_2} \right) \quad (\text{Ref. 2, pg. 451})$$

Where:

- S_c = Secondary settlement, ft
- α = Secondary compression index
- e'_o = Void ratio of the waste layer below the final cover after primary settlement has occurred due to the final cover
- H'_o = Waste thickness below the final cover system after settlement, ft
- t_1 = Starting time of secondary settlement, years
- t_2 = Time at which settlement is determined, years

For this site, assume: $\alpha = 0.06e'_o$ (Ref. 1, pg. 210)

As reported by Sowers (Ref. 1), the secondary compression index is used to estimate waste decomposition. The secondary compression index ranges from $\alpha = 0.03e'_o$ to $\alpha = 0.09e'_o$ for conditions that are unfavorable and favorable to decay, respectively. An average secondary compression index value was chosen because it is consistent with the types of waste accepted in the past. It is also representative of the minimal amount of settlement the site has experienced.

The void ratio of the waste below the final cover at closure is a function of the overburden pressure caused by placement of the final cover system. The void ratio is calculated for each settlement evaluation point using the following equation.

$$e'_o = 1.86 - 0.00102\sigma_o'' \quad (\text{Ref. 5, pg. 590})$$

$$\sigma_o'' = 0.5\gamma'_{msw}H'_o$$

Where:

- σ_o'' = overburden pressure, kPa
- γ'_{msw} = unit weight of waste below the final cover after primary settlement has occurred, pcf

For this site, the void ratio after primary settlement for the waste/cover soils below the final cover system varies between 1.5 to 1.9. Therefore, the secondary compression index will range between 0.09 to 0.11. Most literature sources report the secondary compression index in terms of the "modified secondary compression index" (Refs. 2, 6). The modified secondary compression index, C'_α , is defined by the following:

$$C'_\alpha = \frac{\alpha}{1 + e'_o}$$

The secondary compression index calculated for this site translates to a modified secondary compression index of 0.03 to 0.04 (for a void ratio of 1.5 to 1.9). These values are consistent with reported values for the modified secondary compression index which vary from 0.03 to 0.1 (Refs. 2, 6).

Time frame used for this analysis:

t_1 = 0.083 years
 t_2 = 30 years (postclosure period)

An example calculation of the estimated secondary settlement using the above secondary settlement period is shown for Evaluation Points 1 and 2. The estimated secondary settlement for all evaluation points is shown on Sheet IILL-B-2-8.

Final Cover Settlement Analysis

Client: City of Del Rio
Project: Major Permit Amendment
Description: Final Cover Settlement Analysis

Date: 8/7/2024
Job No: DELR2000302
By: T. Metaferia
Checked By: B. Hindman

At Evaluation Point 1:

$$H'_o = H_o - S_p$$

$$H'_o = 60.8 \text{ ft}$$

$$\sigma''_o = 0.5\gamma'_{msw}H'_o$$

$$\gamma'_{msw} = 74 \text{ pcf}$$

$$\sigma''_o = 2,249 \text{ psf}$$

$$\sigma''_o = 108 \text{ kPa}$$

$$e'_o = 1.86 - 0.00102\sigma''_o$$

$$e'_o = 1.75$$

$$\alpha = 0.06e'_o$$

$$= 0.11$$

$$S_c = \frac{H'_o\alpha}{1 + e'_o} \log\left(\frac{t_1}{t_2}\right)$$

$$S_c = 5.9 \text{ ft}$$

At Evaluation Point 2:

$$H'_o = H_o - S_p$$

$$H'_o = 48.8 \text{ ft}$$

$$\sigma''_o = 0.5\gamma'_{msw}H'_o$$

$$\gamma'_{msw} = 70 \text{ pcf}$$

$$\sigma''_o = 1,707 \text{ psf}$$

$$\sigma''_o = 82 \text{ kPa}$$

$$e'_o = 1.86 - 0.00102\sigma''_o$$

$$e'_o = 1.78$$

$$\alpha = 0.06e'_o$$

$$= 0.11$$

$$S_c = \frac{H'_o\alpha}{1 + e'_o} \log\left(\frac{t_1}{t_2}\right)$$

$$S_c = 4.8 \text{ ft}$$

Step 3 - Estimate total settlement of waste below the final cover system.

Total settlement is the combination of primary and secondary settlement. An example calculation of the estimated total settlement is shown below for Evaluation Points 1 and 2. The estimated total settlement for all evaluation points is shown on page IILL-B-2-8.

At Evaluation Point 1:

Thickness of waste column = 62 ft
 Primary Settlement, S_p = 1.2 ft
 Secondary Settlement, S_c = 5.9 ft
 Total Settlement = 7.1 ft

At Evaluation Point 2:

Thickness of waste column = 50 ft
 Primary Settlement, S_p = 1.2 ft
 Secondary Settlement, S_c = 4.8 ft
 Total Settlement = 6.0 ft

Final Cover Settlement Analysis

Client: City of Del Rio
Project: Major Permit Amendment
Description: Final Cover Settlement Analysis

Date: 8/7/2024
Job No: DELR2000302
By: T. Metaferia
Checked By: B. Hindman

Step 4 - Verify that strain induced on the geocomposite due to settlement is within acceptable limits.

Determine the post-settlement slope of the final cover system and verify the strain induced on the geocomposite due to settlement is within acceptable limits.

Note that negative values indicate the components are in compression.

$$\text{Strain} = \frac{L_f - L_o}{L_o} \times 100$$

L_f = Final distance between evaluation points after total settlement, ft

L_o = Initial distance between evaluation points before total settlement, ft

An example calculation of the estimated strain is shown below for Evaluation Points FC1 and 2. The estimated strain for all evaluation points is shown on page HIE-B-3-11.

At Evaluation Point 1 to Elevation Point 2:

Initial Distance:

Evaluation Point 1 Elevation = 1110 ft-msl

Evaluation Point 2 Elevation = 1080 ft-msl

Plan View Distance = 972.88 ft

L_o = 973.34 ft

Total Settlement:

Total Settlement Point 1 = 7.1 ft

Total Settlement Point 2 = 6.0 ft

Final Distance (after settlement):

Evaluation Point 1 Elevation = 1102.85 ft-msl

Evaluation Point 2 Elevation = 1073.99 ft-msl

Plan View Distance = 972.88 ft

L_f = 973.31 ft

Strain = -0.004 %

Final Cover Settlement Analysis

Client: City of Del Rio
Project: Major Permit Amendment
Description: Final Cover Settlement Analysis

Date: 3/7/2025
Job No: DELR2000302
By: T. Metaferia
Checked By: B. Hindman

Final Cover Evaluation - Settlement Summary Table

Evaluation Point ¹	Initial Top of Final Cover Elevation (ft-msl)	Initial Top of Waste Elevation (ft-msl)	Bottom of Waste Elevation (ft-msl)	H _o (ft)	Y _{msw} (pcf)	σ' _o (psf)	Δσ (psf)	e _o	C _c	S _p (ft)	H' _o (ft)	Y' _{msw} (pcf)	σ'' _o (psf)	e' _o	α	S _c (ft)	Total Settlement (ft)	Post-Settlement Top of Final Cover Elevation (ft-msl)
1	1110.0	1107.0	1045.0	62.0	51	1568.0	348.0	1.78	0.62	1.2	60.8	51	1537.4	1.8	0.11	6.0	7.2	1102.8
2	1080.0	1077.0	1027.0	50.0	49	1221.5	348.0	1.80	0.63	1.2	48.8	49	1191.6	1.8	0.11	4.8	6.0	1074.0
3	1110.0	1107.0	1027.0	80.0	53	2126.6	348.0	1.76	0.61	1.2	78.8	53	2095.3	1.8	0.11	7.7	8.9	1101.1
4	1060.0	1057.0	1056.0	1.0	42	20.9	348.0	1.86	0.65	0.3	0.7	42	15.0	1.9	0.11	0.1	0.4	1059.6
5	1110.0	1107.0	1019.0	88.0	54	2389.7	348.0	1.74	0.61	1.2	86.8	54	2358.3	1.7	0.10	8.5	9.6	1100.4
6	1060.0	1057.0	1054.0	3.0	42	63.2	348.0	1.86	0.65	0.6	2.4	42	51.5	1.9	0.11	0.2	0.8	1059.2
7	1124.0	1121.0	1022.0	99.0	56	2766.6	348.0	1.72	0.60	1.1	97.9	56	2735.0	1.7	0.10	9.5	10.6	1113.4
8	1110.0	1107.0	1023.0	84.0	54	2257.0	348.0	1.75	0.61	1.2	82.8	54	2225.7	1.8	0.11	8.1	9.3	1100.7

¹ Refer to Sheet IIII-B-18 for Evaluation Point locations (1 thru 8).

Final Cover Settlement Analysis

Client: City of Del Rio
Project: Major Permit Amendment
Description: Final Cover Settlement Analysis

Date: 3/7/2025
Job No: DELR2000302
By: T. Metaferia
Checked By: B. Hindman

Final Cover Evaluation - Strain Summary

Evaluation Point ¹		Initial Top of Final Cover Elevation (ft-msl)		Post-Settlement Top of Final Cover Elevation (ft-msl)		Plan View Distance (ft)	L _o (ft)	L _r (ft)	Initial Slope (ft/ft)	Post-Settlement Slope (ft/ft)	Strain (%)
A	B	A	B	A	B						
2	1	1080.0	1110.0	1074.0	1102.8	788.5	789.1	789.0	-0.038	-0.037	-0.005
4	3	1060.0	1110.0	1059.6	1101.1	285.0	289.4	288.0	-0.173	-0.144	-0.467
6	5	1060.0	1110.0	1059.2	1100.4	282.0	286.4	285.0	-0.175	-0.144	-0.492
8	7	1110.0	1124.0	1100.7	1113.4	661.7	661.8	661.8	-0.021	-0.019	-0.004

¹ Refer to Sheet IILL-B-18 for Evaluation Point locations. The "A" and "B" points represent the upgradient and downgradient endpoints, respectively.

Conclusions:

Compacted clay component of final cover has the smallest average allowable tensile strain value which is 0.5% (Reference 2, pg 469)
The maximum calculated strain (0.5%) represents compression versus tensile strain and is acceptable, therefore the system will be stable.

CITY OF DEL RIO LANDFILL

VAL VERDE COUNTY, TEXAS

TCEQ PERMIT NO. MSW-207C

MAJOR PERMIT AMENDMENT APPLICATION PART III — SITE DEVELOPMENT PLAN

APPENDIX IIIN NO MIGRATION DEMONSTRATION

Prepared for
City of Del Rio

September 2023
Revision 1 August 2024
[Revision 2 March 2025](#)



Tewobista Metaferia

Prepared by
CP&Y an STV Company
TPBE Registration No. F-1741
13155 Noel Road, Suite 200
Dallas, TX 75240
214-638-0500

This document is intended for permitting purposes only.

TABLE OF CONTENTS

1.0 INTRODUCTION IIIN-1

2.0 CONTAINMENT SYSTEM IIIN-1

2.1 Pre-Subtitle D Area Liner IIIN-1

2.2 Subtitle D Alternative Liner..... IIIN-1

2.3 Overliner IIIN-1

3.0 SITE GEOLOGY IIIN-2

3.1 Landfill Stratigraphy..... IIIN-2

4.0 HYDROGEOLOGY AND GROUNDWATER CHARACTERISTICS IIIN-5

4.1 Regional Aquifers..... IIIN-5

4.2 Site Hydrogeology..... IIIN-6

4.2.1 1986 and 1994 Groundwater Investigation IIIN-6

4.3 Groundwater Investigation 2020..... IIIN-7

5.0 GROUNDWATER MONITORING WAIVER..... IIIN-13

6.0 NO MIGRATION DEMONSTRATION..... IIIN-13

6.1 HELP Model Demonstration IIIN-13

6.1.1 HELP Model IIIN-13

6.1.2 HELP Model Input..... IIIN-13

6.1.2.1 Moisture Content and Field Capacity IIIN-14

6.1.2.2 Climate Data Input..... IIIN-14

6.1.2.3 Landfill Profile IIIN-14

6.2 MULTIMED Model Demonstration IIIN-15

6.2.1 Description of Model Input IIIN-16

6.2.2 Sensitivity Analysis IIIN-19

6.3 Travel Time to Calaveras Creek..... IIIN-21

7.0 RESULTS AND CONCLUSIONS..... IIIN-23

~~**HELP MODEL RAINFALL RECHARGE CALCULATION..... IIIN-B-1**~~

Appendix IIIN-A – MULTIMED

Appendix IIIN-B – Rainfall Recharge



LIST OF TABLES

Table 3-1 – Stratigraphic Chart IIN-3

Table 4-1 – Del Rio Clay Thickness and Salmon Peak Aquifer Elevations IIN-6

Table 6-1 – Landfill Conditions Modeled in HELP IIN-14

Table 6-2 – Chemical Specific Data IIN-16

Table 6-3 – Source Specific Data IIN-17

Table 6-4 – Unsaturated Flow Model Data IIN-18

Table 6-5 – Unsaturated Transport Model Data IIN-18

Table 6-6 – Aquifer Specific Data IIN-19

Table 6-7 – Sensitivity of Time of Travel to Input Parameters IIN-20

LIST OF FIGURES

[Figure 2.1 – Site Plan..... IIN-1a](#)

[Figure 3.1 – Landfill Cross Section \(1994 TETCO\)..... IIN-4](#)

Figure ~~1&H~~ 4.1 – Top of Edwards Elevation & Limits of Buda Limestone IIN-9

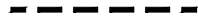







Figure ~~1&H~~ 4.2 – Cross Section A-A’ IIN-10

Figure ~~1&H~~ 4.3 – Arias Boring Piezometer Location IIN-11

Figure ~~1&H~~ 4.4 – Cross Section B-B’ IIN-12



LEGEND

-  PROPOSED PERMIT BOUNDARY
-  PROPOSED LIMITS OF WASTE
-  - 1084 - EXISTING GRADES
-  BP1 GAS PROBE
-  GV1 GAS VENT
-  EXISTING SITE FENCE
-  EXISTING CHUTE
-  CLOSED CELLS (REFER TO NOTE 3)
-  CELL DESIGNATION

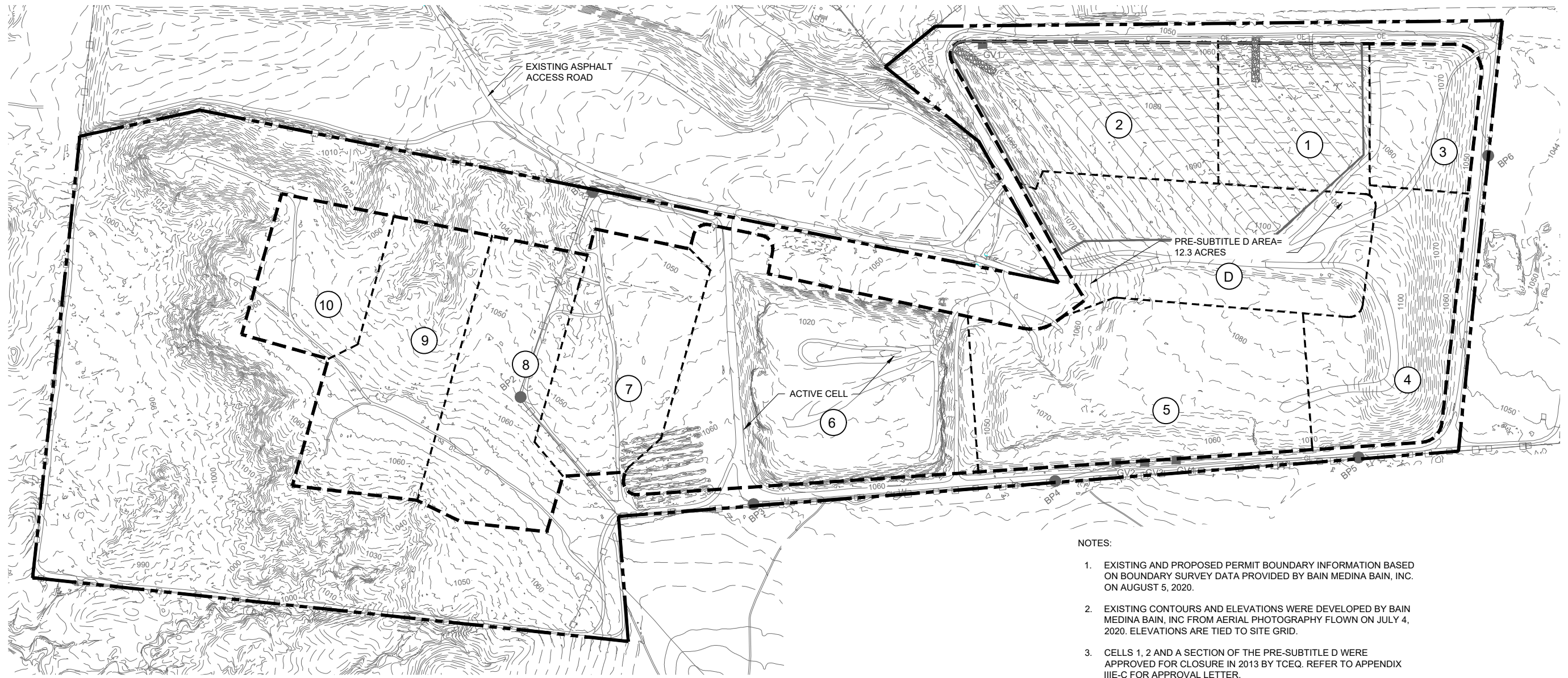
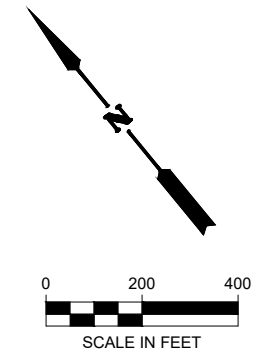

NOTES:

1. EXISTING AND PROPOSED PERMIT BOUNDARY INFORMATION BASED ON BOUNDARY SURVEY DATA PROVIDED BY BAIN MEDINA BAIN, INC. ON AUGUST 5, 2020.
2. EXISTING CONTOURS AND ELEVATIONS WERE DEVELOPED BY BAIN MEDINA BAIN, INC FROM AERIAL PHOTOGRAPHY FLOWN ON JULY 4, 2020. ELEVATIONS ARE TIED TO SITE GRID.
3. CELLS 1, 2 AND A SECTION OF THE PRE-SUBTITLE D WERE APPROVED FOR CLOSURE IN 2013 BY TCEQ. REFER TO APPENDIX III-C FOR APPROVAL LETTER.



NO.	1.	2ND TECHNICAL	NO. D	STV	BY	DATE
						03/2025

VERIFY SCALE: BAR LENGTH EQUALS ONE INCH ON ORIGINAL DRAWING. VERIFY LENGTH ON THIS SHEET 0' 1" AND ADJUST SCALE ACCORDINGLY.

CITY OF DEL RIO LANDFILL NO. 207C
MAJOR PERMIT AMENDMENT

SITE PLAN

DESIGN: T. METAFERIA
DRAWN: T. METAFERIA
REVIEW: B. HINDMAN
CP&Y: DELR200302
CLIENT: CITY OF DEL RIO

FIGURE
2.1

 NEW DRAWING ADDED
Page IIIN-1a
FOR PERMITTING PURPOSES ONLY

- **Liner System** – The Subtitle D clay liner designed for developed and undeveloped cells consists of a 24-inch-thick compacted clay liner with a hydraulic conductivity of 1×10^{-7} cm/s. Default soil characteristics from the HELP model were selected for the compacted clay liner.
- **Overliner System** – The overliner system consists of a GCL and 40-mil LLDPE geomembrane. The geomembrane liner was modeled for a good quality installation with four (4) construction defects per acre, and a production pinhole density of 1 hole/acre. Default soil characteristic from the HELP Model were selected for the LLDPE geomembrane hydraulic conductivity.
- **Leachate Collection System** – Developed Subtitle D Cells 1 through 5 were constructed with an LCS that includes a 200-mil thick single-sided geocomposite material (floor grades).
- **Waste Layers** – Various waste thicknesses were modeled to represent the various stages of landfill development in the Subtitle D and pre-subtitle D areas. A default wilting point was selected from HELP to represent municipal solid waste. The moisture content, field capacity, and porosity values were selected as discussed previously.
- **Intermediate Cover** – The intermediate cover consists of a 12-inch-thick layer of soil placed over the waste. Default soil characteristics were selected from HELP to represent the available onsite soils with a hydraulic conductivity of 6.4×10^{-5} cm/s.
- **Final Cover** – The final cover over the Subtitle D and pre-Subtitle D areas consists of a 12-inch erosion layer with the top 6 inches capable of sustaining growth of vegetation and an 18-inch infiltration layer. The infiltration layer consists of compacted soil with a hydraulic conductivity of $1 \times 10^{-2.5}$ cm/s.

6.2 MULTIMED Model Demonstration

The MULTIMED Model Version 2.00 was used to assess contaminant fate and transport between the landfill and the uppermost aquifer. MULTIMED was developed by the Athens Environmental Research Laboratory for the Environmental Protection Agency. MULTIMED estimates the capacity of the hydrogeologic system modeled to dilute and attenuate contaminant concentrations. The model can be used to simulate the fate and transport processes in both the unsaturated and the saturated subsurface environments.

The unsaturated-zone flow module is used to simulate steady state one dimensional (vertical) flow in the unsaturated zone using a “semi analytical” method. The output from the unsaturated-zone flow is then used as an input in the unsaturated-zone transport module. The transport module then simulates a steady-state or transient, one-dimensional (vertical) transport in the unsaturated one and includes the effects of longitudinal dispersion, liner absorption, and first-order decay. Output from the unsaturated-zone transport module, contaminant concentrations at the water table (either steady state or time series), is used to join the unsaturated-zone transport module with the steady-state or transient, semi analytical saturated-zone transport module.

The saturated-zone transport module simulates one-dimensional (horizontal) uniform flow three-dimensional dispersion, linear adsorption, first order decay, and dilution resulting from direct infiltration into the ground-water plume. MULTIMED doesn't simulate processes such as flow in fractures and chemical reactions between contaminants. The model transport modules assume piston flow, continuous, spatially distributed diffuse recharge through the entire unsaturated zone.

CITY OF DEL RIO LANDFILL

VAL VERDE COUNTY, TEXAS

TCEQ PERMIT NO. MSW-207C

MAJOR PERMIT AMENDMENT APPLICATION PART IV – SITE OPERATING PLAN

Prepared for
City of Del Rio

September 2023
Revision 1 August 2024
Revision 2 March 2025



Teobista Metaferia

Prepared by
CP&Y an STV Company
TPBE Registration No. F-1741
13155 Noel Road, Suite 200
Dallas, TX 75240
214-638-0500

This document is intended for permitting purposes only.

TABLE OF CONTENTS

1.0 PURPOSE IV-1

2.0 RECORDKEEPING REQUIREMENTS IV-2

2.1 Required Records.....IV-2

2.2 Training RecordsIV-3

2.3 Additional Records.....IV-4

3.0 WASTE ACCEPTANCE RATES IV-6

4.0 LANDFILL PERSONNEL IV-7

4.1 Organizational ChartIV-7

4.2 Key PersonnelIV-9

4.2.1 City ManagerIV-9

4.2.2 Public Works Director/City Engineer.....IV-9

4.2.3 Landfill Coordinator (City).....IV-9

4.2.4 Landfill Superintendent (Landfill Operator).....IV-9

4.2.5 Equipment Operators (Landfill Operator).....IV-10

4.2.6 Landfill AttendantsIV-10

4.2.7 Spotter (Landfill Operator).....IV-10

4.2.8 Laborers.....IV-10

5.0 FACILITY EQUIPMENTIV-11

5.1 Minimum Equipment.....IV-11

5.2 Supplemental EquipmentIV-12

6.0 GENERAL INSTRUCTIONSIV-13

7.0 PERSONNEL TRAININGIV-13

7.1 New Employee Orientation and TrainingIV-14

7.2 Additional Training.....IV-14

8.0 DETECTION AND PREVENTION OF DISPOSAL OF PROHIBITED WASTE.....IV-15

8.1 Types of Waste ReceivedIV-15

8.2 Control of Incoming WasteIV-16

8.3 Random InspectionsIV-17

8.4 Unloading Areas.....IV-19

8.5 Waste Unloading ProceduresIV-20

8.6 Special Waste Acceptance ProcedureIV-20

9.0 FIRE PROTECTIONIV-23

9.1 Local Fire DepartmentIV-23

9.2 Fire Event Rules.....IV-24

9.3 Fire Protection and Prevention.....IV-25

9.4 Solid Waste Fires at the Working FaceIV-25

9.5 Fires at the Brush Stockpile/Mulching AreaIV-27

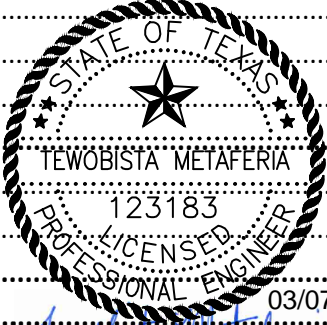

9.6	Burning Waste (Hot Loads)	IV-27
9.7	Vehicle and Fuel Fires	IV-27
9.8	Fire Fighting Plan.....	IV-28
9.9	Soil Stockpile	IV-29
9.10	TCEQ Notification.....	IV-29
10.0	ACCESS CONTROL.....	IV-30
10.1	Control Measures	IV-30
10.2	Access Breach	IV-30
11.0	UNLOADING OF WASTE.....	IV-32
12.0	FACILITY OPERATING HOURS.....	IV-32
13.0	SITE SIGN	IV-33
14.0	CONTROL OF WINDBLOWN SOLID WASTE AND LITTER.....	IV-33
15.0	EASEMENTS AND BUFFER ZONES.....	IV-34
16.0	LANDFILL MARKERS AND BENCHMARK.....	IV-34
16.1	Landfill Markers	IV-34
16.2	Site Benchmark	IV-35
17.0	MATERIALS ALONG THE ROUTE TO THE SITE	IV-36
18.0	DISPOSAL OF LARGE ITEMS	IV-36
19.0	ODOR MANAGEMENT PLAN	IV-37
19.1	General.....	IV-37
19.2	Odor Management Plan.....	IV-37
20.0	DISEASE VECTOR CONTROL	IV-39
21.0	SITE ACCESS ROADS	IV-39
21.1	All Weather Roads	IV-39
21.2	Particulate and Dust Control.....	IV-40
22.0	SALVAGING AND SCAVENGING.....	IV-41
23.0	ENDANGERED SPECIES PROTECTION.....	IV-42
24.0	LANDFILL GAS CONTROL.....	IV-42
25.0	OIL, GAS, AND WATER WELLS.....	IV-43
26.0	COMPACTION	IV-43
27.0	LANDFILL COVER	IV-44
27.1	Daily Cover	IV-44
27.2	Alternative Daily Cover	IV-44
27.3	Intermediate Cover.....	IV-44
27.4	Final Cover	IV-45
27.5	Cover Log	IV-45
27.6	Erosion of Cover.....	IV-45
28.0	PONDED WATER	IV-46
29.0	WASTE IN ENCLOSED CONTAINERS AT TYPE IV LANDFILLS.....	IV-47



30.0 DISPOSAL OF SPECIAL WASTEIV-47

31.0 DISPOSAL OF INDUSTRIAL WASTE.....IV-47

32.0 VISUAL SCREENING OF DEPOSITED WASTE.....IV-47

33.0 CONTAMINATED WATER DISCHARGEIV-48

 33.1 Minimizing Contaminated WaterIV-48

 33.2 Disposal of Contaminated Water and LeachateIV-48

34.0 LEACHATE AND GAS CONDENSATE RECIRCULATION.....IV-48

35.0 SITE INSPECTION AND MAINTENANCE LIST SUMMARY.....IV-48

APPENDIX IV-A – Alternate Daily Cover Operating Plan

APPENDIX IV-B – Landfill Checklist

LIST OF TABLES

Table 2-1 Required PlansIV-2

Table 2-2 Required Operating Record InformationIV-3

Table 2-3 Required Training Records.....IV-4

Table 2-4 Additional Records.....IV-4

Table 3-1 Waste Acceptance Rate RecordsIV-6

Table 3-2 Waste Acceptance Rate RecordsIV-6

Table 5-1 Minimum Equipment.....IV-12

Table 5-2 Supplemental EquipmentIV-12

Table 7-1 Prevention Training.....IV-14

Table 8-1 Random Inspection ScheduleIV-17

Table 8-2 Unloading Areas.....IV-19

Table 9-1 Fire Extinguisher List.....IV-25

Table 9-2 Time to Place Soil Cover.....IV-26

Table 10-1 Access Breach Reporting RequirementsIV-31

Table 16-1 Marker ColorIV-35

Table 19-1 Odor Control MeasuresIV-38

Table 35-1 Site Inspection and Maintenance SummaryIV-4935

LIST OF FIGURES

Figure 4-1 - Organizational Chart.....IV-8



Table 35-1 - Site Inspections are summarized here and any corrective actions taken shall be documented in the Site Operating Record.

ITEM INSPECTED	TASK	Frequency	Inspector	Referenced In this SOP
Fence/Gates	Inspect perimeter fence and gates for damage. Make repairs if necessary.	Weekly	Landfill Coordinator or Designee	Section 10.2
Windblown Waste	Police working face area, access roads, entrance areas, and perimeter fence for loose trash. Clean up as necessary.	Daily	Landfill Superintendent or Designee	Section 14
Waste Spilled on Route to the Site	Police the entrance areas and all roads at least 2 miles from the site entrances for loose trash. Clean up as necessary.	Daily	Landfill Superintendent or Designee	Section 17
Landfill Markers	Inspect all landfill markers for damage, color-coding, and general location. Correct or replace damaged markers within 15 days of discovery.	Monthly	Landfill Coordinator or Designee	Section 16.1
Site Access Road	Inspect site access road for damage from vehicle traffic, erosion, or excessive mud accumulation. Maintain as needed. Grading equipment will be used control or remove mud accumulations on roads as well as minimize depressions, ruts, and potholes.	Daily – more often during wet weather or extended dry weather periods.	Landfill Coordinator & Superintendent or Designee	Section 21
Daily Cover	Inspect for erosion, proper placement, thickness, and compaction. Correct problems as needed. Verify that vectors are not an issue.	Daily at the active face and all daily cover areas will be inspected.	Landfill Superintendent or Designee	Section 27.1
Intermediate Cover	Inspect for proper placement, thickness, erosion, compaction, settlement, and for presence of waste or other contamination. Correct problems as needed.	Weekly and within 72-hours of a rainfall event of 0.5 inches or more.	Landfill Superintendent or Designee	Section 27.3
Final Cover	Inspect for proper placement, thickness, compaction, slope, settlement and erosion. Maintenance will be ongoing throughout post-closure care period. Correct problems as needed.	Weekly and within 72-hours of a rainfall event of 0.5 inches or more.	Landfill Superintendent or Designee	Section 27.4
Leachate	Measure depth of leachate in sump, as required.	Weekly	Landfill Coordinator or Designee	Section 33
Leachate Odor	Inspect the caps and piping of the cleanout riser and sump riser of the leachate collection system to prevent potential odor escape.	Monthly	Landfill Coordinator or Designee	Table 19.1
Site Signs	Inspect all site signs for damage, general location, and accuracy of posted information.	Weekly	Landfill Coordinator or Designee	Section 13
Ponded Water	Inspect site for ponded water areas. Correct problems as needed.	Weekly and within 72-hours of a rainfall event of 0.5 inches or more.	Landfill Superintendent or Designee	Section 28 & 33
Odor	Inspect the perimeter of the site to assess the performance of site operations to control odor.	Daily	Landfill Coordinator & Superintendent or Designee	Section 19.2
Perimeter Channels/Ponds/Chutes/Swales	Inspect perimeter channels, berms/dikes, chutes and swales for erosion, settlement, obstructions, silt and sediment build-up to verify that they are functioning as designed. Inspect for presence of sediment discharges along the site boundary in areas which have been disturbed by site activities.	Weekly and within 72-hours of a rainfall event of 0.5 inches or more.	Landfill Coordinator & Superintendent or Designee	Section 33